

Installation Instructions

Original Instructions



Allen-Bradley

by ROCKWELL AUTOMATION

FLEX I/O Digital Input Modules

Catalog Number 1794-IB8, 1794-IB16, 1794-IB32, 1794-IB32K

Topic	Page
Summary of Changes	1
Environment and Enclosure	3
Prevent Electrostatic Discharge	3
European Hazardous Location Approval	3
North American Hazardous Location Approval	4
Install Your Digital Input Module	5
Configure Your Input Module	8
Specifications	9

Summary of Changes

This publication contains the following new or updated information. This list includes substantive updates only and is not intended to reflect all changes.

Topic	Page
Added information on RSLogix 5000 software re-branding	4
Updated template	throughout
Added new K catalog 1794-IB32K	throughout
Updated certifications	12



ATTENTION: Read this document and the documents listed in the Additional Resources section about installation, configuration and operation of this equipment before you install, configure, operate or maintain this product. Users are required to familiarize themselves with installation and wiring instructions in addition to requirements of all applicable codes, laws, and standards.

Activities including installation, adjustments, putting into service, use, assembly, disassembly, and maintenance are required to be carried out by suitably trained personnel in accordance with applicable code of practice. If this equipment is used in a manner not specified by the manufacturer, the protection provided by the equipment may be impaired.

注意：在安装、配置、操作和维护本产品前，请阅读本文档以及“其他资源”部分列出的有关设备安装、配置和操作的相应文档。除了所有适用规范、法律和标准的相关要求之外，用户还必须熟悉安装和接线说明。

安装、调整、投运、使用、组装、拆卸和维护等各项操作必须由经过适当训练的专业人员按照适用的操作规范实施。

如果未按照制造商指定的方式使用该设备，则可能会损害设备提供的保护。

ATENCIÓN: Antes de instalar, configurar, poner en funcionamiento o realizar el mantenimiento de este producto, lea este documento y los documentos listados en la sección Recursos adicionales acerca de la instalación, configuración y operación de este equipo. Los usuarios deben familiarizarse con las instrucciones de instalación y cableado y con los requisitos de todos los códigos, leyes y estándares vigentes. El personal debidamente capacitado debe realizar las actividades relacionadas a la instalación, ajustes, puesta en servicio, uso, ensamblaje y mantenimiento de conformidad con el código de práctica aplicable. Si este equipo se usa de una manera no especificada por el fabricante, la protección provista por el equipo puede resultar afectada.

ATENÇÃO: Leia este e os demais documentos sobre instalação, configuração e operação do equipamento que estão na seção Recursos adicionais antes de instalar, configurar, operar ou manter este produto. Os usuários devem se familiarizar com as instruções de instalação e fiação além das especificações para todos os códigos, leis e normas aplicáveis.

É necessário que as atividades, incluindo instalação, ajustes, colocação em serviço, utilização, montagem, desmontagem e manutenção sejam realizadas por pessoal qualificado e especializado, de acordo com o código de prática aplicável.

Caso este equipamento seja utilizado de maneira não estabelecida pelo fabricante, a proteção fornecida pelo equipamento pode ficar prejudicada.

ВНИМАНИЕ: Перед тем как устанавливать, настраивать, эксплуатировать или обслуживать данное оборудование, прочитайте этот документ и документы, перечисленные в разделе «Дополнительные ресурсы». В этих документах изложены сведения об установке, настройке и эксплуатации данного оборудования. Пользователи обязаны ознакомиться с инструкциями по установке и прокладке соединений, а также с требованиями всех применимых норм, законов и стандартов.

Все действия, включая установку, наладку, ввод в эксплуатацию, использование, сборку, разборку и техническое обслуживание, должны выполняться обученным персоналом в соответствии с применимыми нормами и правилами.

Если оборудование используется не предусмотренным производителем образом, защита оборудования может быть нарушена.

注意：本製品を設置、構成、稼働または保守する前に、本書および本機器の設置、設定、操作についての参考資料の該当箇所に記載されている文書に目を通してください。ユーザは、すべての該当する条例、法律、規格の要件に加えて、設置および配線の手順に習熟している必要があります。

設置調整、運転の開始、使用、組立て、解体、保守を含む諸作業は、該当する実施規則に従って訓練を受けた適切な作業員が実行する必要があります。

本機器が製造メーカーにより指定されていない方法で使用されている場合、機器により提供されている保護が損なわれる恐れがあります。

ACHTUNG: Lesen Sie dieses Dokument und die im Abschnitt „Weitere Informationen“ aufgeführten Dokumente, die Informationen zu Installation, Konfiguration und Bedienung dieses Produkts enthalten, bevor Sie dieses Produkt installieren, konfigurieren, bedienen oder warten. Anwender müssen sich neben den Bestimmungen aller anwendbaren Vorschriften, Gesetze und Normen zusätzlich mit den Installations- und Verdrahtungsanweisungen vertraut machen.

Arbeiten im Rahmen der Installation, Anpassung, Inbetriebnahme, Verwendung, Montage, Demontage oder Instandhaltung dürfen nur durch ausreichend geschulte Mitarbeiter und in Übereinstimmung mit den anwendbaren Ausführungsvorschriften vorgenommen werden.

Wenn das Gerät in einer Weise verwendet wird, die vom Hersteller nicht vorgesehen ist, kann die Schutzfunktion beeinträchtigt sein.

ATTENTION : Lisez ce document et les documents listés dans la section Ressources complémentaires relatifs à l'installation, la configuration et le fonctionnement de cet équipement avant d'installer, configurer, utiliser ou entretenir ce produit. Les utilisateurs doivent se familiariser avec les instructions d'installation et de câblage en plus des exigences relatives aux codes, lois et normes en vigueur.

Les activités relatives à l'installation, le réglage, la mise en service, l'utilisation, l'assemblage, le démontage et l'entretien doivent être réalisées par des personnes formées selon le code de pratique en vigueur.

Si cet équipement est utilisé d'une façon qui n'a pas été définie par le fabricant, la protection fournie par l'équipement peut être compromise.

주의：본 제품 설치, 설정, 작동 또는 유지보수하기 전에 본 문서를 포함하여 설치, 설정 및 작동에 관한 참고 자료 섹션의 문서들을 반드시 읽고 숙지하십시오. 사용자는 모든 관련 규정, 법규 및 표준에서 요구하는 사항에 대해 반드시 설치 및 배선 지침을 숙지해야 합니다.

설치, 조정, 가동, 사용, 조립, 분해, 유지보수 등 모든 작업은 관련 규정에 따라 적절한 교육을 받은 사용자를 통해서만 수행해야 합니다.

본 장비를 제조사가 명시하지 않은 방법으로 사용하면 장비의 보호 기능이 손상될 수 있습니다.

ATTENZIONE Prima di installare, configurare ed utilizzare il prodotto, o effettuare interventi di manutenzione su di esso, leggere il presente documento ed i documenti elencati nella sezione “Altre risorse”, riguardanti l'installazione, la configurazione ed il funzionamento dell'apparecchiatura. Gli utenti devono leggere e comprendere le istruzioni di installazione e cablaggio, oltre ai requisiti previsti dalle leggi, codici e standard applicabili.

Le attività come installazione, regolazioni, utilizzo, assemblaggio, disassemblaggio e manutenzione devono essere svolte da personale adeguatamente addestrato, nel rispetto delle procedure previste.

Qualora l'apparecchio venga utilizzato con modalità diverse da quanto previsto dal produttore, la sua funzione di protezione potrebbe venire compromessa.

DIKKAT: Bu ürünün kurulumu, yapılındırılması, işletilmesi veya bakımı öncesinde bu dokümanı ve bu ekipmanın kurulumu, yapılındırılması ve işletimi ile ilgili ilave Kaynaklar bölümünde yer listelenmiş dokümanları okuyun. Kullanıcılar yürürlükteki tüm yönetmelikler, yasalar ve standartların gereksinimlerine ek olarak kurulum ve kablolama talimatlarını da öğrenmek zorundadır.

Kurulum, ayarlama, hizmete alma, kullanma, parçaları birleştirme, parçaları sökme ve bakım gibi aktiviteler sadece uygun eğitimleri almış kişiler tarafından yürürlükteki uygulama yönetmeliklerine uygun şekilde yapılabilir.

Bu ekipman üretici tarafından belirlenmiş amacın dışında kullanılırsa, ekipman tarafından sağlanan koruma bozulabilir.

注意事項：在安装、設定、操作或維護本產品前，請先閱讀此文件以及列於「其他資源」章節中有關安裝、設定與操作此設備的文件。使用者必須熟悉安裝和配線指示，並符合所有法規、法律和標準要求。

包括安裝、調整、交付使用、使用、組裝、拆卸和維護等動作都必須交由已經過適當訓練的人員進行，以符合適用的實作法規。

如果將設備用於非製造商指定的用途時，可能會造成設備所提供的保護功能受損。

POZOR: Než začnete instalovat, konfigurovat či provozovat tento výrobek nebo provádět jeho údržbu, přečtěte si tento dokument a dokumenty uvedené v části Dodatečné zdroje ohledně instalace, konfigurace a provozu tohoto zařízení. Uživatelé se musejí vedle požadavků všech relevantních vyhlášek, zákonů a norem nutně seznámit také s pokyny pro instalaci a elektrické zapojení.

Činnosti zahrnující instalaci, nastavení, uvedení do provozu, užívání, montáž, demontáž a údržbu musí vykonávat vhodně proškolený personál v souladu s příslušnými prováděcími předpisy.

Pokud se toto zařízení používá způsobem neodpovídajícím specifikaci výrobce, může být narušena ochrana, kterou toto zařízení poskytuje.

UWAGA: Przed instalacją, konfiguracją, użytkowaniem lub konserwacją tego produktu należy przeczytać niniejszy dokument oraz wszystkie dokumenty wymienione w sekcji Dodatkowe źródła omawiające instalację, konfigurację i procedury użytkowania tego urządzenia. Użytkownicy mają obowiązek zapoznać się z instrukcjami dotyczącymi instalacji oraz oprzewodowania, jak również z obowiązującymi kodeksami, prawem i normami.

Działania obejmujące instalację, regulację, przekazanie do użytkowania, użytkowanie, montaż, demontaż oraz konserwację muszą być wykonywane przez odpowiednio przeszkolony personel zgodnie z obowiązującym kodeksem postępowania.

Jeśli urządzenie jest użytkowane w sposób inny niż określony przez producenta, zabezpieczenie zapewniane przez urządzenie może zostać ograniczone.

Obs! Läs detta dokument samt dokumentet, som står listat i avsnittet Övriga resurser, om installation, konfigurering och drift av denna utrustning innan du installerar, konfigurerar eller börjar använda eller utföra underhållsarbete på produkten. Användare måste bekanta sig med instruktioner för installation och kabeldragning, förutom krav enligt gällande koder, lagar och standarder.

Åtgärder som installation, justering, service, användning, montering, demontering och underhållsarbete måste utföras av personal med lämplig utbildning enligt lämpligt bruk.

Om denna utrustning används på ett sätt som inte anges av tillverkaren kan det hända att utrustningens skyddsanordningar försätts ur funktion.

LET OP: Lees dit document en de documenten die genoemd worden in de paragraaf Aanvullende informatie over de installatie, configuratie en bediening van deze apparatuur voordat u dit product installeert, configureert, bedient of onderhoudt. Gebruikers moeten zich vertrouwd maken met de installatie en de bedringsinstructies, naast de vereisten van alle toepasselijke regels, wetten en normen.

Activiteiten zoals het installeren, afstellen, in gebruik stellen, gebruiken, monteren, demonteren en het uitvoeren van onderhoud mogen uitsluitend worden uitgevoerd door hiervoor opgeleid personeel en in overeenstemming met de geldende praktijkregels.

Indien de apparatuur wordt gebruikt op een wijze die niet is gespecificeerd door de fabrikant, dan bestaat het gevaar dat de beveiliging van de apparatuur niet goed werkt.

Environment and Enclosure



ATTENTION: This equipment is intended for use in a Pollution Degree 2 industrial environment, in overvoltage Category II applications (as defined in EN/IEC 60664-1), at altitudes up to 2000 m (6562 ft) without derating. This equipment is not intended for use in residential environments and may not provide adequate protection to radio communication services in such environments.

This equipment is supplied as open-type equipment for indoor use. It must be mounted within an enclosure that is suitably designed for those specific environmental conditions that will be present and appropriately designed to prevent personal injury resulting from accessibility to live parts. The enclosure must have suitable flame-retardant properties to prevent or minimize the spread of flame, complying with a flame spread rating of 5VA or be approved for the application if nonmetallic. The interior of the enclosure must be accessible only by the use of a tool. Subsequent sections of this publication may contain more information regarding specific enclosure type ratings that are required to comply with certain product safety certifications. In addition to this publication, see the following:

- Industrial Automation Wiring and Grounding Guidelines, publication [1770-4.1](#), for more installation requirements.
- NEMA Standard 250 and EN/IEC 60529, as applicable, for explanations of the degrees of protection provided by enclosures.

Prevent Electrostatic Discharge



ATTENTION: This equipment is sensitive to electrostatic discharge, which can cause internal damage and affect normal operation. Follow these guidelines when you handle this equipment:

- Touch a grounded object to discharge potential static.
- Wear an approved grounding wriststrap.
- Do not touch connectors or pins on component boards.
- Do not touch circuit components inside the equipment.
- Use a static-safe workstation, if available.
- Store the equipment in appropriate static-safe packaging when not in use.

European Hazardous Location Approval

The following modules are European Zone 2 approved: 1794-IB8, 1794-IB16.

The following applies to products marked CE Ex II 3 G:

- Are intended for use in potentially explosive atmospheres as defined by European Union Directive 2014/34/EU and has been found to comply with the Essential Health and Safety Requirements relating to the design and construction of Category 3 equipment intended for use in Zone 2 potentially explosive atmospheres, given in Annex II to this Directive.
- Compliance with the Essential Health and Safety Requirements has been assured by compliance with EN 60079-15 and EN 60079-0.
- Are Equipment Group II, Equipment Category 3, and comply with the Essential Health and Safety Requirements relating to the design and construction of such equipment given in Annex II to EU Directive 2014/34/EU. See the EU Declaration of Conformity at rok.auto/certifications for details.
- The type of protection is Ex nA IIC T3 Gc (**1794-IB8**) and Ex nA IIC T4 Gc (**1794-IB16**) according to EN 60079-15.
- Comply to Standards EN 60079-0:2012, EN 60079-15:2010, reference certificate number LCIE 01 ATEX 6020 X (**1794-IB8**) and DEMKO 14 ATEX 1342501X (**1794-IB16**).
- Are intended for use in areas in which explosive atmospheres caused by gases, vapors, mists, or air are unlikely to occur, or are likely to occur only infrequently and for short periods. Such locations correspond to Zone 2 classification according to ATEX directive 2014/34/EU.

IEC Hazardous Location Approval

The following applies to products with IECEx certification: (1794-IB16)

- Are intended for use in areas in which explosive atmospheres caused by gases, vapors, mists, or air are unlikely to occur, or are likely to occur only infrequently and for short periods. Such locations correspond to Zone 2 classification to IEC 60079-0.
- The type of protection is Ex nA IIC T4 Gc according to IEC 60079-15.
- Comply to Standards IEC 60079-0 6th Edition, IEC 60079-15 4th Edition reference IECEx certificate number IECEx UL 14.0066X.



WARNING: Special Conditions for Safe Use:

- This equipment shall be mounted in an ATEX/IECEx Zone 2 certified enclosure with a minimum ingress protection rating of at least IP54 (in accordance with EN/IEC 60079-0) and used in an environment of not more than Pollution Degree 2 (as defined in EN/IEC 60664-1) when applied in Zone 2 environments. The enclosure must be accessible only by the use of a tool.
- This equipment shall be used within its specified ratings defined by Rockwell Automation.
- Provision shall be made to prevent the rated voltage from being exceeded by transient disturbances of more than 140% of the peak rated voltage when applied in Zone 2 environments.
- The instructions in the user manual shall be observed.
- This equipment must be used only with ATEX/IECEx certified Rockwell Automation backplanes.
- Earthing is accomplished through mounting of modules on rail.
- Devices shall be used in an environment of not more than Pollution Degree 2.





WARNING: Secure any external connections that mate to this equipment by using screws, sliding latches, threaded connectors, or other means provided with this product. Do not disconnect equipment unless power has been removed or the area is known to be nonhazardous.



WARNING: When you insert or remove the module while backplane power is on, an electric arc can occur. This could cause an explosion in hazardous location installations.
Be sure that power is removed or the area is nonhazardous before proceeding. Repeated electric arcing causes excessive wear to contacts on both the module and its mating connector. Worn contacts may create electrical resistance that can affect module operation.

North American Hazardous Location Approval

The Following Information Applies When Operating This Equipment In Hazardous Locations.	Informations sur l'utilisation de cet équipement en environnements dangereux.
<p>Products marked "CL I, DIV 2, GP A, B, C, D" are suitable for use in Class I Division 2 Groups A, B, C, D, Hazardous Locations and nonhazardous locations only. Each product is supplied with markings on the rating nameplate indicating the hazardous location temperature code. When combining products within a system, the most adverse temperature code (lowest "T" number) may be used to help determine the overall temperature code of the system. Combinations of equipment in your system are subject to investigation by the local Authority Having Jurisdiction at the time of installation.</p>	<p>Les produits marqués "CL I, DIV 2, GP A, B, C, D" ne conviennent qu'à une utilisation en environnements de Classe I Division 2 Groupes A, B, C, D dangereux et non dangereux. Chaque produit est livré avec des marquages sur sa plaque d'identification qui indiquent le code de température pour les environnements dangereux. Lorsque plusieurs produits sont combinés dans un système, le code de température le plus défavorable (code de température le plus faible) peut être utilisé pour déterminer le code de température global du système. Les combinaisons d'équipements dans le système sont sujettes à inspection par les autorités locales qualifiées au moment de l'installation.</p>
 <p>WARNING: Explosion Hazard -</p> <ul style="list-style-type: none"> Do not disconnect equipment unless power has been removed or the area is known to be nonhazardous. Do not disconnect connections to this equipment unless power has been removed or the area is known to be nonhazardous. Secure any external connections that mate to this equipment by using screws, sliding latches, threaded connectors, or other means provided with this product. Substitution of components may impair suitability for Class I, Division 2. 	 <p>AVERTISSEMENT: Risque d'Explosion -</p> <ul style="list-style-type: none"> Couper le courant ou s'assurer que l'environnement est classé non dangereux avant de débrancher l'équipement. Couper le courant ou s'assurer que l'environnement est classé non dangereux avant de débrancher les connecteurs. Fixer tous les connecteurs externes reliés à cet équipement à l'aide de vis, loquets coulissants, connecteurs filetés ou autres moyens fournis avec ce produit. La substitution de composants peut rendre cet équipement inadapté à une utilisation en environnement de Classe I, Division 2.



ATTENTION: If this equipment is used in a manner not specified by the manufacturer, the protection provided by the equipment may be impaired.
ATTENTION: Read this document and the documents listed in the Additional Resources section about installation, configuration, and operation of this equipment before you install, configure, operate, or maintain this product. Users are required to familiarize themselves with installation and wiring instructions in addition to requirements of all applicable codes, laws, and standards.
ATTENTION: Installation, adjustments, putting into service, use, assembly, disassembly, and maintenance are required to be carried out by suitably trained personnel in accordance with applicable code of practice.
ATTENTION: In case of malfunction or damage, no attempts at repair should be made. The module should be returned to the manufacturer for repair. Do not dismantle the module.
ATTENTION: This equipment is certified for use only within the surrounding air temperature range of -20...+55 °C (-4...+131 °F) (1794-IB8 and 1794-IB16) or 0...55 °C (32...131 °F) (1794-IB32, 1794-IB32K). The equipment must not be used outside of this range.
ATTENTION: Use only a soft dry anti-static cloth to wipe down equipment. Do not use any cleaning agents.



ATTENTION: This product is grounded through the DIN rail to chassis ground. Use zinc-plated chromate-passivated steel DIN rail to assure proper grounding. The use of other DIN rail materials (for example, aluminum or plastic) that can corrode, oxidize, or are poor conductors, can result in improper or intermittent grounding. Secure DIN rail to mounting surface approximately every 200 mm (7.8 in.) and use end-anchors appropriately. Be sure to ground the DIN rail properly. See the Industrial Automation Wiring and Grounding Guidelines, Rockwell Automation publication [1770-4.1](#), for more information.

Compatibility

The Following Communication Adapters are required to ensure compatibility with the 1794-IB32 and 1794-IB32K:

Remote I/O	1794-ASB series E or later 1794-ASB2 series D or later
ControlNet®	1794-ACN15 series C, firmware revision 4.1 or later 1794-ACNR15 series C, firmware revision 4.1 or later
DeviceNet®	1794-ADN Series B, firmware revision 2.4 or greater for out-of-box compatibility
EtherNet/IP™	1794-AENT series A, firmware revision 2.4 or later
PROFIBUS	1794-APB series A, version 1.1 of the GSD file (You can download the GSD file at www.ab.com/networks/gsd .)
ControlLogix® Family	RSLogix 5000® programming software, version 11 or later or Studio 5000 ⁽¹⁾ Logix Designer® application version 20 or later

(1) The Studio 5000 Logix Designer application is the rebranding of RSLogix 5000 software and will continue to be the product to program Logix 5000™ controllers for discrete, process, batch, motion, safety, and drive-based solutions.

Install Your Digital Input Module

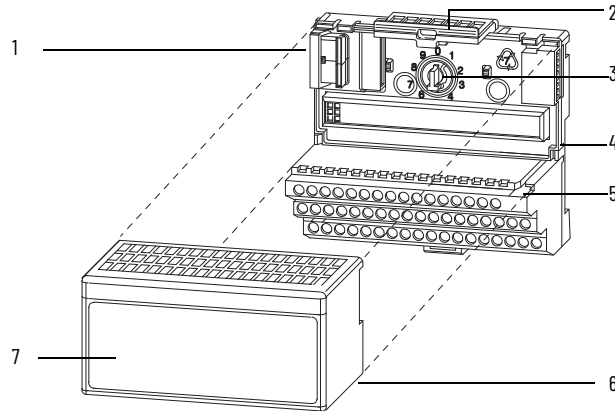

	Description		Description
1	Flexbus connectors	5	Groove
2	Latching mechanism	6	Alignment bar
3	Keyswitch	7	Module
4	Terminal base		

The module mounts on a 1794 terminal base.



ATTENTION: During mounting of all devices, be sure that all debris (metal chips, wire strands, and so on) is kept from falling into the module. Debris that falls into the module could cause damage on power-up.

- Rotate the keyswitch (3) on the terminal base (4) clockwise to position 2 as required for this type of module.
- Make sure the Flexbus connector (1) is pushed all the way to the left to connect with the neighboring terminal base/adaptor. **You cannot install the module unless the connector is fully extended.**
- Make sure the pins on the bottom of the module are straight so they align properly with the connector in the terminal base.



WARNING: If you insert or remove the module while backplane power is on, an electrical arc can occur. This could cause an explosion in hazardous location installations. Be sure that power is removed or the area is nonhazardous before proceeding.

- Position the module (7) with its alignment bar (6) aligned with the groove (5) on the terminal base.
- Press firmly and evenly to seat the module in the terminal base unit. The module is seated when the latching mechanism (2) is locked into the module.

Connect Wiring for the 1794-IB8 and 1794-IB16 using a 1794-TB3 or 1794-TB3S

- Connect individual input wiring to numbered terminals on the 0...15 row (A) as indicated in the [Wiring Connections for 1794-IB8 and 1794-IB16 using a 1794-TB3 or 1794-TB3S Terminal Base](#) table.
- Connect the associated +V DC power lead of the input device to the corresponding terminal on the 34...51 row (C) for each input as indicated in the [Wiring Connections for 1794-IB8 and 1794-IB16 using a 1794-TB3 or 1794-TB3S Terminal Base](#) table. (The +V power terminals of row (C) are internally connected together.)
- Connect the associated input common (3-wire devices only) to the corresponding terminal on the 16...33 row (B) for each input as indicated in the [Wiring Connections for 1794-IB8 and 1794-IB16 using a 1794-TB3 or 1794-TB3S Terminal Base](#) table. (Commons are internally connected together.)
- Connect +V DC power to terminal 34 on the 34...51 row (C).
- Connect DC common to terminal 16 on the 16...33 row (B).
- If daisy chaining power to the next terminal base, connect a jumper from terminal 51 (+V DC) on this base unit to terminal 34 on the next base unit.
- If continuing DC common to the next base unit, connect a jumper from terminal 33 (common) on this base unit to terminal 16 on the next base unit.

Wiring Connections for 1794-IB8 and 1794-IB16 using a 1794-TB3 or 1794-TB3S Terminal Base

Input ⁽¹⁾	Input Terminal	Voltage Terminal	Common Terminal ⁽²⁾
Input 0	A-0	C-35	B-17
Input 1	A-1	C-36	B-18
Input 2	A-2	C-37	B-19
Input 3	A-3	C-38	B-20
Input 4	A-4	C-39	B-21

Wiring Connections for 1794-IB8 and 1794-IB16 using a 1794-TB3 or 1794-TB3S Terminal Base (Continued)

Input ⁽¹⁾	Input Terminal	Voltage Terminal	Common Terminal ⁽²⁾
Input 5	A-5	C-40	B-22
Input 6	A-6	C-41	B-23
Input 7	A-7	C-42	B-24
Input 8	A-8	C-43	B-25
Input 9	A-9	C-44	B-26
Input 10	A-10	C-45	B-27
Input 11	A-11	C-46	B-28
Input 12	A-12	C-47	B-29
Input 13	A-13	C-48	B-30
Input 14	A-14	C-49	B-31
Input 15	A-15	C-50	B-32
+V DC	C-34...C-51		
Common	B-16...B-33		

(1) 1794-IB8: Inputs 0...7; 1794-IB16: Inputs 0...15.
 (2) 3-wire devices use signal, supply and common. 2-wire devices use signal and supply

1794-TB3 and 1794-TB3S Terminal Base Wiring for 1794-IB8 and 1794-IB16

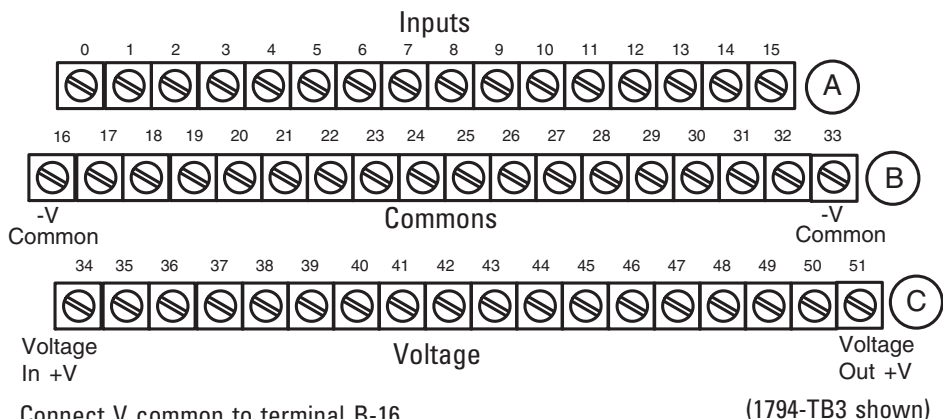

Connect V common to terminal B-16.
 Connect +V to terminal C-34.
 Use B-33 and C-51 to daisy-chain to the next terminal base unit.

2-Wire and 3-Wire Input Wiring for 1794-IB8 and 1794-IB16

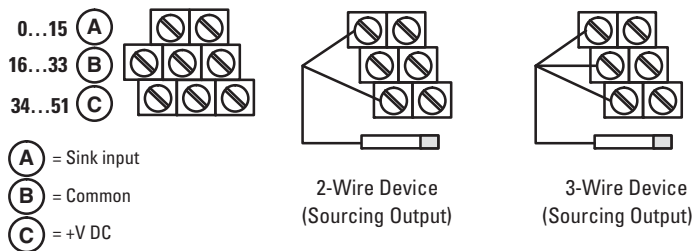

Connect Wiring for the 1794-IB32 and 1794-IB32K using a 1794-TB32 or 1794-TB32S Terminal Base



WARNING: When used in a Class 1, Division 2, hazardous location, this equipment must be mounted in a suitable enclosure with proper wiring method that complies with the governing electrical codes.

1. Connect individual input wiring (IN0...IN15) to numbered terminals on the 0...15 row (A) as indicated in the [Wiring Connections for 1794-IB32 and 1794-IB32K using a 1794-TB32 or 1794-TB32S Terminal Base on page 7](#) table.
2. Connect the associated power to the +V1 terminal (35, 37, 39, or 41) on the 34...51 row (C) as indicated in the [Wiring Connections for 1794-IB32 and 1794-IB32K using a 1794-TB32 or 1794-TB32S Terminal Base on page 7](#) table.

3. Connect the associated common for IN0...IN15 to COM1 (terminal 36, 38, 40, or 42) on the 34...51 row (C) as indicated in the [Wiring Connections for 1794-IB32 and 1794-IB32K using a 1794-TB32 or 1794-TB32S Terminal Base on page 7](#) table.
4. Connect individual input wiring (IN16...IN31) to numbered terminals on the 16...33 row (B) as indicated in the [Wiring Connections for 1794-IB32 and 1794-IB32K using a 1794-TB32 or 1794-TB32S Terminal Base on page 7](#) table.
Do not connect to terminals 16 or 33.
5. Connect the associated power to the +V2 terminal (43, 45, 47, or 49) on the 34...51 row (C) as indicated in the [Wiring Connections for 1794-IB32 and 1794-IB32K using a 1794-TB32 or 1794-TB32S Terminal Base on page 7](#) table.
6. Connect the associated common for IN16...IN31 to COM2 (terminal 44, 46, 48, or 50) on the 34...51 row (C).
7. If continuing input wiring power for IN0...IN15 to the next terminal base, connect a jumper from terminal 41 (+V1) on this terminal base unit to the power terminal on the next terminal base unit. See the installation instructions for the specific terminal base unit.
8. If continuing input wiring IN0...IN15 common to the next terminal base, connect a jumper from terminal 42 (COM1) on this terminal base unit to the common terminal on the next terminal base unit.
9. If continuing input wiring power for IN16...IN31 to the next terminal base, connect a jumper from terminal 49 (+V2) on this terminal base unit to the power terminal on the next terminal base unit. See the installation instructions for the specific terminal base unit.
10. If continuing input wiring IN16...IN31 common to the next terminal base, connect a jumper from terminal 50 (COM2) on this terminal base unit to the common terminal on the next terminal base unit.

Wiring Connections for 1794-IB32 and 1794-IB32K using a 1794-TB32 or 1794-TB32S Terminal Base

Input ⁽¹⁾	Signal	Input	Signal
IN 0	A-0	IN 16	B-17
IN 1	A-1	IN 17	B-18
IN 2	A-2	IN 18	B-19
IN 3	A-3	IN 19	B-20
IN 4	A-4	IN 20	B-21
IN 5	A-5	IN 21	B-22
IN 6	A-6	IN 22	B-23
IN 7	A-7	IN 23	B-24
IN 8	A-8	IN 24	B-25
IN 9	A-9	IN 25	B-26
IN 10	A-10	IN 26	B-27
IN 11	A-11	IN 27	B-28
IN 12	A-12	IN 28	B-29
IN 13	A-13	IN 29	B-30
IN 14	A-14	IN 30	B-31
IN 15	A-15	IN 31	B-32
+V1 DC power (inputs IN0...IN15)	Power terminals 35, 37, 39, and 41 for IN0...IN15. +V1 connected to terminals 35, 37, 39, and 41.		
COM1 DC Return (inputs IN0...IN15)	Common terminals 36, 38, 40, and 42 for IN0...IN15. V1 Return connected to terminals 36, 38, 40, and 42.		
+V2 DC power (inputs IN16...IN31)	Power terminals 43, 45, 47, and 49 for IN16...IN31. +V2 connected to terminals 43, 45, 47, and 49.		
COM2 DC Return (inputs IN16...IN31)	Common terminals 44, 46, 48, and 50 for IN16...IN31. V2 Return connected to terminals 44, 46, 48, and 50.		

(1) 3-wire devices use signal, return, and supply. 2-wire devices use signal and supply

1794-TB32 and 1794-TB32S Terminal Base Wiring for 1794-IB32 and 1794-IB32K

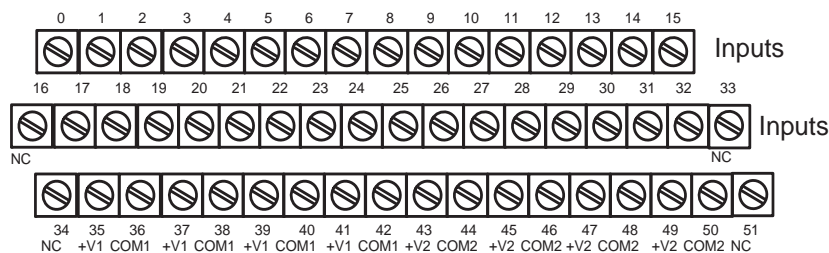

- +V1 = Terminals 35, 37, 39, and 41 (1794-TB32 shown)
- +V2 = Terminals 43, 45, 47, and 49
- COM1 = Terminals 36, 38, 40, and 42
- COM2 = Terminals 44, 46, 48, and 50
- NC = No connections (terminals 16, 33, 34, and 51)

Configure Your Input Module

Configure your input module by setting bits in the configuration word (write word).

Table 1 - Image Table Memory Map for the 1794-IB8 Module

Dec	15	14	13	12	11	10	9	8	7	6	5	4	3	2	1	0
Oct	17	16	15	14	13	12	11	10	7	6	5	4	3	2	1	0
Read 1	Not used								I7	I6	I5	I4	I3	I2	I1	I0
Write 1	Not used												Input Filter 0...7			
Where	I = Input															

Table 2 - Image Table Memory Map for the 1794-IB16 Module

Dec	15	14	13	12	11	10	9	8	7	6	5	4	3	2	1	0
Oct	17	16	15	14	13	12	11	10	7	6	5	4	3	2	1	0
Read 1	I15	I14	I13	I12	I11	I10	I9	I8	I7	I6	I5	I4	I3	I2	I1	I0
Read 2	C = Counter Input value of input 15															
Write 1	Not used		CF	CR							Input Filter 12...15			Input Filter 0...11		
Where	I = Input C = Counter value for input 15 CF = Counter fast - where 1 = fast input (raw data), 0 standard input filtered data CR = Counter reset															
Note:	C, CR, and CF not available when used with any series 1794-ASB or 1794-ASB2 remote I/O adapters.															

Table 3 - Image Table Memory Map for the 1794-IB32 and 1794-IB32K Modules

Dec	15	14	13	12	11	10	9	8	7	6	5	4	3	2	1	0
Oct	17	16	15	14	13	12	11	10	7	6	5	4	3	2	1	0
Read 1	I15	I14	I13	I12	I11	I10	I9	I8	I7	I6	I5	I4	I3	I2	I1	I0
Read 2	I31	I30	I29	I28	I27	I26	I25	I24	I23	I22	I21	I20	I19	I18	I17	I16
Write 1	Not used						Input Filter FT 0...31				Not used					
Where	I = Input status FT = Input filter time															

Set the Input Filter Time

To set the input filter time, set the associated bits in the output image table (complementary word) for the module.

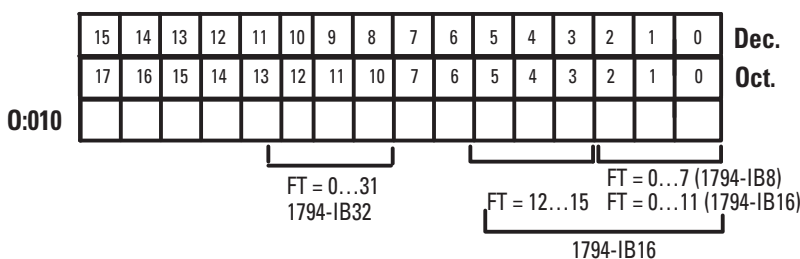

For example, to increase the off-to-on filter time to 4 ms for all inputs at address rack 1, module group 0 (using 1794-IB32, 1794-IB32K as an example), set the following bits and program.

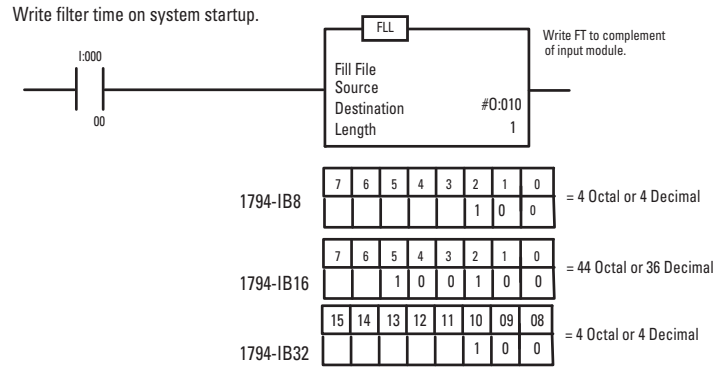

See the [Input Filter Time](#) table for other bit settings.

Table 4 - Input Filter Time

Bits			Description	Filter Time
02	01	00	Filter Time for inputs 0...7 (1794-IB8)	1794-IB8, 1794-IB16, 1794-IB32, 1794-IB32K
02	01	00	Filter Time for inputs 0...11 (1794-IB16)	
05	04	03	Filter Time for inputs 12...15 (1794-IB16)	
10	09	08	Filter Time for inputs 0...32 (1794-IB32, 1794-IB32K)	Off to On/On to Off
0	0	0	Filter Time 0 (Default)	0.25 ms
0	0	1	Filter Time 1	0.5 ms
0	1	0	Filter Time 2	1 ms
0	1	1	Filter Time 3	2 ms
1	0	1	Filter Time 4	4 ms
1	0	1	Filter Time 5	8 ms
1	1	0	Filter Time 6	16 ms
1	1	1	Filter Time 7	32 ms

Specifications

Attribute	Value
Number of inputs	8, current, sinking
Recommended terminal base unit	1794-TB3, 1794-TB3S, 1794-TB3K, 1794-TB3SK, 1794-TBKD, 1794-TB37DS
On-state voltage, min	10V DC
On-state voltage, nom	24V DC
On-state voltage, max	31.2V DC
On-state current, min	2.0 mA
On-state current, nom	8.0 mA
On-state current, max	12.0 mA
Off-state voltage, max	5.0V DC
Off-state current, max	1.5 mA
Nominal input impedance	4.6 kΩ
Isolation voltage	50V (continuous), Basic Insulation Type Type tested @ 850V DC for 60 s, between field side and system No isolation between individual channels
Flexbus current	20 mA @ 5V DC
Power dissipation, max	3.5 W @ 31.2V DC
Thermal dissipation, max	11.9 BTU/hr @ 31.2V DC

Specifications – 1794-IB16

Attribute	Value
Number of inputs	16, current, sinking
Recommended terminal base unit	1794-TB3, 1794-TB3S, 1794-TB3K, 1794-TB3SK, 1794-TBKD, 1794-TB37DS
On-state voltage, min	10V DC
On-state voltage, nom	24V DC
On-state voltage, max	31.2V DC
On-state current, min	2.0 mA
On-state current, nom	8.0 mA
On-state current, max	12.0 mA
Off-state voltage, max	5.0V DC
Off-state current, max	1.5 mA
Nominal input impedance	4.6 kΩ
Isolation voltage	50V (continuous), Basic Insulation Type Type tested @ 707V DC for 60 s, between field side and system No isolation between individual channels
Flexbus current	30 mA @ 5V DC
Power dissipation, max	6.1 W @ 31.2V DC
Thermal dissipation, max	20.8 BTU/hr @ 31.2V DC

Specifications – 1794-IB32 and 1794-IB32K

Attribute	Value
Number of inputs	32, current, sinking
Recommended terminal base unit	1794-TB32, 1794-TB32S, 1794-TB62DS, 1794-TB62EXD4X15
On-state voltage, min	19.2V DC
On-state voltage, nom	24V DC
On-state voltage, max	31.2V DC
On-state current, min	2.0 mA
On-state current, nom	4.1 mA @ 24V DC
On-state current, max	6.0 mA
Off-state voltage, max	5.0V DC
Off-state current, max	1.5 mA
Nominal input impedance	22.2 kΩ
Isolation voltage	50V (continuous), Basic Insulation Type Type tested @ 2121V DC for 2 s, between field side and system No isolation between individual channels
Flexbus current	25 mA @ 5V DC
Power dissipation, max	6.0 W @ 31.2V DC
Thermal dissipation, max	20.47 BTU/hr @ 31.2V DC

General Specifications

Attribute	Value
Input filter time	See Input Filter Time table
Terminal base screw torque	Determined by installed terminal base
Dimensions, approx. (H x W x D)	94 x 94 x 69 mm (3.7 x 3.7 x 2.7 in.)
Weight, approx.	71 g (2.50 oz.) – 1794-IB8 74 g (2.61 oz.) – 1794-IB16 79 g (2.79 oz.) – 1794-IB32, 1794-IB32K

General Specifications (Continued)

Attribute	Value
Indicators (field side indication)	8 yellow status indicators - 1794-IB8 16 yellow status indicators - 1794-IB16 32 yellow status indicators - 1794-IB32, 1794-IB32K
External DC power supply voltage, nom	24V DC
External DC power voltage range	10...31.2V DC (includes 5% AC ripple) - 1794-IB8, 1794-IB16 19.2...31.2V DC (includes 5% AC ripple) - 1794-IB32, 1794-IB32K
North American temp code	T3C - 1794-IB8, 1794-IB32, 1794-IB32K T4A - 1794-IB16
IECEX temp code	T4 - 1794-IB16 only
ATEX temp code	T3 - 1794-IB8 T4 - 1794-IB16
Keyswitch position	2
Enclosure type rating	None (open-style)
Wire size	Determined by installed terminal base
Wiring category ^{(1) (2)}	2 - on signal ports

(1) Use this Conductor Category information for planning conductor routing. See the Industrial Automation Wiring and Grounding Guidelines, publication [1770-4.1](#).

(2) Use this Conductor Category information for planning conductor routing as described in the appropriate System Level Installation Manual.

Environmental Specifications

Attribute	Value
Temperature, operating	IEC 60068-2-1 (Test Ad, Operating Cold), IEC 60068-2-2 (Test Bd, Operating Dry Heat), IEC 60068-2-14 (Test Nb, Operating Thermal Shock): -20...+55 °C (-4...+131 °C) - 1794-IB8, 1794-IB16 0...55 °C (32...131 °F) - 1794-IB32, 1794-IB32K
Temperature, surrounding air, max	55 °C (131 °F)
Temperature, nonoperating	IEC 60068-2-1 (Test Ab, Unpackaged Nonoperating Cold), IEC 60068-2-2 (Test Bb, Unpackaged Nonoperating Dry Heat), IEC 60068-2-14 (Test Na, Unpackaged Nonoperating Thermal Shock): -40...+85 °C (-40...+185 °F)
Relative humidity	IEC 60068-2-30 (Test Db, Unpackaged Damp Heat): 5...95% noncondensing
Vibration	IEC60068-2-6 (Test Fc, Operating): 5 g @ 10...500 Hz
Shock, operating	IEC60068-2-27 (Test Ea, Unpackaged shock): 30 g
Shock, nonoperating	IEC60068-2-27 (Test Ea, Unpackaged shock): 50 g
Emissions	IEC 61000-6-4
ESD immunity	IEC 61000-4-2: 6 kV contact discharges 8 kV air discharges
Radiated RF immunity	IEC 61000-4-3: (1794-IB8, 1794-IB16) 10V/m with 1 kHz sine-wave 80% AM from 80...2000 MHz 10V/m with 200 Hz 50% Pulse 100% AM @ 900 MHz 10V/m with 200 Hz 50% Pulse 100% AM @ 1890 MHz (1794-IB32, 1794-IB32K) 3V/m with 1 kHz sine-wave 80% AM from 2000...2700 MHz 10V/m with 1 kHz sine-wave 80% AM from 80...1000 MHz

Environmental Specifications (Continued)

Attribute	Value
EFT/B immunity	IEC 61000-4-4: ±2 kV @ 5 kHz on power ports ±2 kV @ 5 kHz on signal ports
Surge transient immunity	IEC 61000-4-5: ±1 kV line-line(DM) and ±2 kV line-earth(CM) on signal ports
Conducted RF immunity	IEC 61000-4-6: 10V rms with 1 kHz sine-wave 80% AM from 150 kHz...80 MHz

Certifications

Certifications (when product is marked) ⁽¹⁾	Value
c-UL-us	<p>For 1794-IB8, 1794-IB16 UL Listed Industrial Control Equipment, certified for US and Canada. See UL File E65584. UL Listed for Class I, Division 2 Group A, B, C, D Hazardous Locations, certified for U.S. and Canada. See UL File E194810.</p> <p>For 1794-IB32, 1794-IB32K UL Listed Industrial Control Equipment, certified for US and Canada. See UL File E322657. UL Listed for Class I, Division 2, Group A, B, C, D Hazardous Locations, certified for US and Canada. See UL File E334470.</p>
CE	<p>European Union 2014/30/EU EMC Directive, compliant with: EN 61326-1; Meas./Control/Lab., Industrial Requirements EN 61000-6-2; Industrial Immunity EN 61000-6-4; Industrial Emissions EN 61131-2; Programmable Controllers (Clause 8, Zone A & B) European Union 2011/65/EU RoHS, compliant with: EN IEC 63000; Technical Documentation</p>
RCM	<p>Australian Radiocommunications Act, compliant with: EN 61000-6-4; Industrial Emissions</p>
Ex	<p>For 1794-IB8 only European Union 2014/34/EU ATEX Directive, compliant with: EN 60079-0; General Requirements EN 60079-15; Potentially Explosive Atmospheres, Protection "n" II 3 G Ex nA IIC T3 Gc LCIE 01ATEX6020X</p> <p>For 1794-IB16 only European Union 2014/34/EU ATEX Directive, compliant with: EN 60079-0; General Requirements EN 60079-15; Potentially Explosive Atmospheres, Protection "n" DEMKO 14ATEX1342501X II 3 G Ex nA IIC T4 Gc</p>
IECEX	<p>For 1794-IB16 only IECEX System, compliant with: IEC 60079-0; General Requirements IEC 60079-15; Potentially Explosive Atmospheres, Protection "n" II 3 G Ex nA IIC T4 Gc IECEX UL 14.0066X</p>
TÜV	<p>For 1794-IB16 only TÜV Certified for Functional Safety: Up to and including SIL 2</p>
KC	<p>Korean Registration of Broadcasting and Communications Equipment, compliant with: Article 58-2 of Radio Waves Act, Clause 3</p>
EAC	<p>Russian Customs Union TR CU 020/2011 EMC Technical Regulation</p>
Morocco	<p>Arrêté ministériel n° 6404-15 du 29 ramadan 1436</p>

(1) See the Product Certification link at rok.auto/certifications for Declarations of Conformity, Certificates, and other certification details.

Derating Chart for 1794-IB16

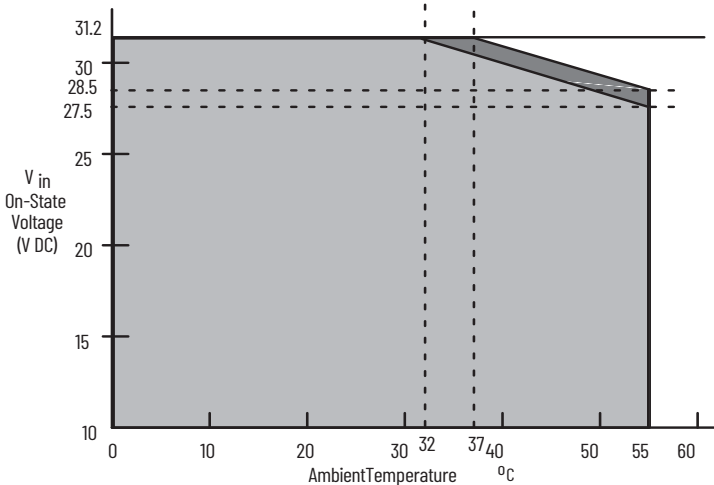

The area within the curve represents the safe operating range for the module under various conditions of user supplied 24V DC supply voltages and ambient temperature.

- = Normal mounting safe operating range, (includes).
- = Other mounting positions (including inverted horizontal) safe operating range

Normal Mounting - Horizontal

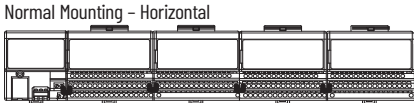

Other Mounting - (including Vertical and Inverted Horizontal Mounting)

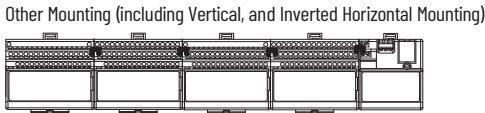

Voltage, max	Temperature, max		Voltage, max	Temperature, max	
	Normal	Other		Normal	Other
31.2	37	32	29.0	51	45
30.5	41	36	28.5	55	48
30.0	45	39	28.0		51
29.5	48	42	27.5		55

Rockwell Automation Support

Use these resources to access support information.

Technical Support Center	Find help with how-to videos, FAQs, chat, user forums, and product notification updates.	rok.auto/support
Knowledgebase	Access Knowledgebase articles.	rok.auto/knowledgebase
Local Technical Support Phone Numbers	Locate the telephone number for your country.	rok.auto/phonesupport
Literature Library	Find installation instructions, manuals, brochures, and technical data publications.	rok.auto/literature
Product Compatibility and Download Center (PCDC)	Download firmware, associated files (such as AOP, EDS, and DTM), and access product release notes.	rok.auto/pcdc

Documentation Feedback

Your comments help us serve your documentation needs better. If you have any suggestions on how to improve our content, complete the form at rok.auto/docfeedback.





Waste Electrical and Electronic Equipment (WEEE)



At the end of life, this equipment should be collected separately from any unsorted municipal waste.

Rockwell Automation maintains current product environmental compliance information on its website at rok.auto/pec.

Rockwell Otomasyon Ticaret A.Ş. Kar Plaza İş Merkezi E Blok Kat:6 34752 İçerenköy, İstanbul, Tel: +90 (216) 5698400 EEE Yönetmeliğine Uygundur

Connect with us.    

rockwellautomation.com — expanding **human possibility**™

AMERICAS: Rockwell Automation, 1201 South Second Street, Milwaukee, WI 53204-2496 USA, Tel: (1) 414.382.2000, Fax: (1) 414.382.4444

EUROPE/MIDDLE EAST/AFRICA: Rockwell Automation NV, Pegasus Park, De Kleetlaan 12a, 1831 Diegem, Belgium, Tel: (32) 2 663 0600, Fax: (32) 2 663 0640

ASIA PACIFIC: Rockwell Automation, Level 14, Core F, Cyberport 3, 100 Cyberport Road, Hong Kong, Tel: (852) 2887 4788, Fax: (852) 2508 1846

Allen-Bradley, ControlLogix, expanding human possibility, FactoryTalk, FLEX, Logix 5000, Rockwell Automation, RSLogix 5000, Studio 5000 Logix Designer, and TechConnect are trademarks of Rockwell Automation, Inc.

ControlNet, DeviceNet and EtherNet/IP are trademarks of ODVA, Inc.

Trademarks not belonging to Rockwell Automation are property of their respective companies.

Publication 1794-IN093F-EN-P - November 2021 | Supersedes Publication 1794-IN093E-EN-P-August 2018

Copyright © 2021 Rockwell Automation, Inc. All rights reserved.