

1395, 1397, and FlexPak 3000 DC Drives to PowerFlex DC Drive

Catalog Numbers 1395, 1397, 20P



Important User Information

Solid-state equipment has operational characteristics differing from those of electromechanical equipment. Safety Guidelines for the Application, Installation and Maintenance of Solid State Controls (publication [SGI-1.1](#) available from your local Rockwell Automation® sales office or online at <http://www.rockwellautomation.com/literature/>) describes some important differences between solid-state equipment and hard-wired electromechanical devices. Because of this difference, and also because of the wide variety of uses for solid-state equipment, all persons responsible for applying this equipment must satisfy themselves that each intended application of this equipment is acceptable.

In no event will Rockwell Automation, Inc. be responsible or liable for indirect or consequential damages resulting from the use or application of this equipment.

The examples and diagrams in this manual are included solely for illustrative purposes. Because of the many variables and requirements associated with any particular installation, Rockwell Automation, Inc. cannot assume responsibility or liability for actual use based on the examples and diagrams.

No patent liability is assumed by Rockwell Automation, Inc. with respect to use of information, circuits, equipment, or software described in this manual.

Reproduction of the contents of this manual, in whole or in part, without written permission of Rockwell Automation, Inc., is prohibited.

Throughout this manual, when necessary, we use notes to make you aware of safety considerations.



WARNING: Identifies information about practices or circumstances that can cause an explosion in a hazardous environment, which may lead to personal injury or death, property damage, or economic loss.



ATTENTION: Identifies information about practices or circumstances that can lead to personal injury or death, property damage, or economic loss. Attentions help you identify a hazard, avoid a hazard, and recognize the consequence.



SHOCK HAZARD: Labels may be on or inside the equipment, for example, a drive or motor, to alert people that dangerous voltage may be present.



BURN HAZARD: Labels may be on or inside the equipment, for example, a drive or motor, to alert people that surfaces may reach dangerous temperatures.

IMPORTANT

Identifies information that is critical for successful application and understanding of the product.

Allen-Bradley, ControlLogix, MicroLogix, DriveExplorer, DriveExecutive, Encompass, PowerFlex, Rockwell Software, Rockwell Automation, and TechConnect are trademarks of Rockwell Automation, Inc.

Trademarks not belonging to Rockwell Automation are property of their respective companies.

Preface	Overview.....	5
	Pre-migration.....	5
	Best Practices	5
	Additional Resources.....	6
	View All Publications for a Specific Drive	7
	 Chapter 1	
Drive Comparisons	Specifications and Features.....	10
	Drive Catalog Number Explanations	18
	Bulletin 1395 Digital DC Drive	18
	Bulletin 1395 Digital DC Drive in Bulletin 2361 Motor Control Centers.....	21
	Bulletin 1397 Digital DC Drive	24
	FlexPak 3000 Digital DC Drive	26
	PowerFlex Digital DC Drive	28
	PowerFlex Digital DC Drive, Continued	29
	Drive Conversion Guides.....	30
	Bulletin 1395 to PowerFlex DC Drive Conversions	30
	Bulletin 1397 to PowerFlex DC Drive Conversions	32
	FlexPak 3000 to PowerFlex DC Drive Conversions	34
	Drive Dimensions.....	36
	Bulletin 1395 Drive Approximate Dimensions.....	36
	Bulletin 1397 Drive Approximate Dimensions.....	39
	FlexPak 3000 Drive Approximate Dimensions.....	43
	PowerFlex DC Drive Approximate Dimensions.....	49
	Power Comparisons.....	54
	1395 Power Connections - Standard Field Voltage	54
	1395 External Field Transformer Connections.....	56
	1397 AC Input Line Connections	57
	1397 Field and Motor Armature Connections	61
	FlexPak 3000 AC Input Line Connections	65
	FlexPak 3000 DC Motor Field and Armature Connections	68
	PowerFlex DC Drive Power Wiring	73
	Control and Feedback Comparisons.....	94
	Bulletin 1395 Digital DC Drive	94
	Bulletin 1397 Digital DC Drive	101
	FlexPak 3000 DC Drive	108
	PowerFlex DC Drive	118
	 Chapter 2	
Wiring Examples	Bulletin 1395 to PowerFlex DC Drive Comparison.....	165
	Bulletin 1397 to PowerFlex DC Drive Comparison.....	169
	FlexPak 3000 to PowerFlex DC Drive Comparison	173

Network Communication

Chapter 3

Overview 177

Bulletin 1395 DC Drive Network Communication Options..... 177

 1395 Node Adapter Board 177

 Multi-Communication Board 178

 ControlNet Adapter Board..... 178

Bulletin 1397 DC Drive Network Communication Options..... 179

FlexPak 3000 DC Drive Network Communication Options..... 180

 ControlNet Network Communication Option Board 180

 AutoMax Network Communication Option Board 180

 DeviceNet Network 180

PowerFlex DC Drive Network Communication Options..... 181

Logic Command and Status 182

 Bulletin 1395 DC Drive..... 182

 Bulletin 1397 DC Drive..... 185

 FlexPak 3000 DC Drive..... 186

 PowerFlex DC Drive..... 188

Rockwell Automation Encompass Partner Migration Offerings 190

 ProLinx 5210-DFNT-RIO 191

 ProLinx 5201-DFNT-DH485..... 191

 AN-X-ABRIO-SCAN 191

 AN-X-DHP..... 192

 AN-X-DCSNet 192

Topic	Page
Overview	5
Pre-migration	5
Additional Resources	6

Overview

The purpose of this publication is to assist in migrating from a 1395, 1397, or FlexPak 3000 DC drive to a PowerFlex® DC drive. Please refer to the respective User Manual, Technical Data and/or Installation Instructions for more detail.

This publication contains these chapters:

- **Chapter 1: Drive Comparisons**
Contains comparisons of the specifications, features, drive catalog numbers, dimensions, power and control terminals, and feedback options of the 1395, 1397, and FlexPak 3000 DC drives to the PowerFlex DC drive. This chapter also provides information on the user-installed options, contactors and recommended fuses for the PowerFlex DC drive.
- **Chapter 2: Wiring Examples**
Contains comparisons of the drive configuration, control wiring and parameters of the 1395, 1397, and FlexPak 3000 DC drives to the PowerFlex DC drive.
- **Chapter 3: Network Communication**
Identifies the 1395, 1397, and FlexPak 3000 drives network options that can be migrated to networks used by the PowerFlex DC drive. This chapter also provides overview information for the velocity reference/feedback, I/O adaptors, 16 bit-based processors (PLC 5) and provides information for Quest (a Rockwell Automation Encompass™ partner), that offers a remote I/O to EtherNet/IP communication convertor migration solution.

Pre-migration

Best Practices

- Upload and save the drive parameters via DriveExplorer™ or DriveExecutive™. If you cannot connect to the drive online, manually record the drive parameter values.
- Record the motor nameplate data, record and label all power, motor, and digital and analog I/O control wiring.
- Upload and save any network files and Programmable Logic Controller (PLC) programs.
- Update and/or markup any changes to hardware prints.

Additional Resources

These documents contain additional information concerning related products from Rockwell Automation.

Resource	Description
1395 DC Drive, 800 . . . 1250 Hp, Firmware Versions 5.xx-9.30 User Manual, publication 1395-UM006	Provides the necessary information to install, program, start up and maintain the 1350 A and 2250 A version of the 1395 DC drive.
1395 Digital DC Drive Firmware Versions 5xx . . . 10.10/9.30 User Manual, publication 1395-UM003	Provides the necessary information to install, program, start up, and maintain the 1395 DC drive.
Bulletin 1395 Digital DC Drive in Bulletin 2361 MCCs User Manual, publication 2361-5.01 .	Provides instructions for installing and operating a high-horsepower 1395 drive.
1397 DC Drive Firmware 2.xx User Manual, publication 1397-UM000	Provides information necessary to install, program, start up, and maintain the 1397 DC drive.
FlexPak 3000 Digital DC Drive Hardware Reference, Installation and Troubleshooting Version 4.3, publication FP3-UM012	Provides information necessary to install, start up, and troubleshoot the FlexPak 3000 DC drive.
FlexPak 3000 Digital DC Drive Software Reference Manual Version 4.3, publication FP3-UM013	Describes the software of the FlexPak 3000 DC drive.
PowerFlex Digital DC Drive User Manual, publication 20P-UM001	Provides the basic information needed to install, start up, program, and troubleshoot the PowerFlex DC drive.
PowerFlex Digital DC Drive Technical Data, publication 20P-TD001	Provides information on drive specifications and features.
Industrial Automation Wiring and Grounding Guidelines, publication 1770-4.1	Provides general guidelines for installing a Rockwell Automation industrial system.
Product Certifications website, http://www.ab.com	Provides declarations of conformity, certificates, and other certification details.

You can view or download publications at <http://www.rockwellautomation.com/literature/>. To order paper copies of technical documentation, contact your local Allen-Bradley® distributor or Rockwell Automation sales representative.

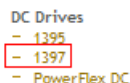
View All Publications for a Specific Drive

You can view a list of all available publications for a specific drive on the Rockwell Automation Literature Library. For example, to view all publications for the 1397 drive, follow these steps:

1. On the Rockwell Automation Literature Library Home page, click Drives (Allen-Bradley).



2. Scroll down and click 1397.



The list of available publications for the Bulletin 1397 DC drive are displayed.

DRIVES (ALLEN-BRADLEY)

DC Drives

1397 ▾

Not finding what you're looking for? Also see: [Drives \(Allen-Bradley\) > General Information](#)

Page: 1 2 [Next] Showing 1 - 20 of 25

Sort: Title ▾ Ascending ▾ >> New Search: Keyword ▾ >> [Advanced Search](#)
[Search Tips](#)

Title	Cat. No(s).Pub. Type	Pub. No.	Language	Date	Info	PDF
1370 DC Loop Contactors, Lugs and Dynamic Brakes	20P, 1370 Technical Data	1370-TD001A-EN-P	English	October 2008		723KB
1397 115V AC Control Interface Card Inst.	1397 Installation Instructions	1397-5.18	English	March 1997		89KB
1397 150HP AC Line Disconnect Inst.	1397 Installation Instructions	1397-5.21	English	July 1997		225KB
1397 200-300HP AC Line Disconnect Inst.	1397 Installation Instructions	1397-5.27	English	October 1997		208KB
1397 250-600HP DB Resistor Kit Inst.	1397 Installation Instructions	1397-5.32	English	August 1998		41KB
1397 400-600 Hp Inverter Fault Circuit Breaker - IFB600	1397 Installation Instructions	1397-5.29	English	September 1998		298KB
1397 400-600 HP SCR Replacement	1397 Service Bulletin	1397-5B001C-EN-P	English	August 2006		2425KB

Notes:

Drive Comparisons

This chapter provides comparisons of each drives specifications and features, catalog number explanations, ratings, dimensions, power and control wiring and options.

Topic	Page
Specifications and Features	10
Drive Catalog Number Explanations	18
Bulletin 1395 Digital DC Drive	18
Bulletin 1395 Digital DC Drive in Bulletin 2361 Motor Control Centers	21
Bulletin 1397 Digital DC Drive	24
FlexPak 3000 Digital DC Drive	26
PowerFlex Digital DC Drive	28
Drive Conversion Guides	30
Bulletin 1395 to PowerFlex DC Drive Conversions	30
Bulletin 1397 to PowerFlex DC Drive Conversions	32
FlexPak 3000 to PowerFlex DC Drive Conversions	34
Drive Dimensions	36
Bulletin 1395 Drive Approximate Dimensions	36
Bulletin 1397 Drive Approximate Dimensions	39
FlexPak 3000 Drive Approximate Dimensions	43
PowerFlex DC Drive Approximate Dimensions	49
Power Comparisons	54
1395 Power Connections - Standard Field Voltage	54
1395 External Field Transformer Connections	56
1397 AC Input Line Connections	57
1397 Field and Motor Armature Connections	61
FlexPak 3000 AC Input Line Connections	65
FlexPak 3000 DC Motor Field and Armature Connections	68
PowerFlex DC Drive Power Wiring	73
Control and Feedback Comparisons	94
Bulletin 1395 Digital DC Drive	94
Bulletin 1397 Digital DC Drive	101
FlexPak 3000 DC Drive	108
PowerFlex DC Drive	118

Specifications and Features

This section compares the specifications and features of your existing 1395, 1397, or FlexPak 3000 DC drive to the PowerFlex DC drive.

Table 1 - Drive Specification and Feature Comparisons

Attributes	1395	1397	FlexPak 3000	PowerFlex DC
Catalog Reference	1395...	1397...		20P...
AC Input Ratings				
100...115V	n/a	n/a	n/a	n/a
200...240V	0.75...224 kW 1...300 Hp	1.1...111 kW 1.5...150 Hp	1.5...300 Hp 7...1000 A	1.5...300 Hp 7...1050 A
400...480V	1.5...500 Hp (400 VDC) 2...600 Hp (500 VDC)	2.2...448 kW 3...600 Hp	3...600 Hp 6...960 A	2...900 Hp 4.1...1494 A
500...600V	n/a	n/a	n/a	n/a
690V	n/a	n/a	n/a	n/a
Ambient Temperature Limit	IP00 / Open = 55 °C	IP00 / Open = 55 °C	IP00 / Open = 55 °C	IP20 / Open = 50 °C (55°C with derating)
Field Supply	Single phase internal or external	Single phase internal	Single phase internal	150V and 300V, current reg. single phase internal or external
EMC Filters	n/a	External	External	External
Armature Input Type	6-pulse	6-pulse	6-pulse	6-pulse standard
Performance				
Overload Capability	Heavy Duty Application 150% - 60 s 200% - 10 s 260% - 5 s	Heavy Duty Application 150% - 60 s 200% - 5 s	Heavy Duty Application 150% - 60 s 200% - 5 s	Heavy Duty Application 150% - 60 s 200% - 3 s
Control Performance	Full wave, full control, 6-SCR	Full wave, full control, 6-SCR	Full wave, full control, 6-SCR	Full wave, full control, 6-SCR
Control Features	Drive overload protection PI control (Spd or Trq) Spd/Trq/Min/Max/Sum Droop Feedback loss switchover	Drive overtemp. protection PI control (Spd or Trq) Inertia compensation Droop PI outer control loop / Process trim	Drive overtemp. protection PI control (Spd or Trq) Inertia compensation Droop PI outer control loop / Process trim WebPak 3000 (winder app.)	Drive overload protection PID control (Spd or Trq) Adaptive gain Droop Feedback loss switchover Winder control
Operating Speed Range	100:1 encoder	200:1 encoder	200:1 encoder	1000:1 DC tachometer 100:1 armature feedback 1000:1 encoder
Field Control	Field economize Field weakening	Fixed field - standard Regulated - optional, provides field economize and weakening	Fixed field - standard Regulated - optional, provides field economize and weakening	Field economize Field weakening

Table 1 - Drive Specification and Feature Comparisons (Continued)

Attributes	1395	1397	FlexPak 3000	PowerFlex DC
Interface				
User Interface	Programming/Control terminal Remote terminal DriveExecutive	Local ScanPort HIMs Remote ScanPort HIMs DriveExplorer DriveExecutive	Five-language graphical LCD Operator Interface Module (OIM) CS3000 Control/Configuration Software	Local PowerFlex HIMs Remote PowerFlex HIMs DriveExplorer DriveExecutive Connected Components Workbench
Communications Options	ControlNet Remote I/O DH+ Serial Node adapter board (PLC3/5) Multi-communication board	Internal - ScanPort DeviceNet ControlNet Remote I/O DF1/DH485	Internal - Serial AutoMax network DeviceNet ControlNet Profibus Interbus - S	Internal - DPI BACnet DeviceNet ControlNet EtherNet/IP Remote I/O ⁽¹⁾ RS485 DF-1 RS485 HVAC Modbus RTU Modbus/TCP PROFIBUS DP Interbus - S
Preset Speeds	5	3 (with I/O expansion)	3 (with I/O expansion)	7
Standard Analog Inputs	0	2 fixed (12 bit + sign, ±1V or mA, ±1V)	2 fixed (12 bit + sign, ±1V or mA, ±1V)	3 configurable (11 bit + sign, each ±V or mA)
Standard Digital Inputs	4 fixed 24V DC	10 - Fixed 24V DC	10 - Fixed 24V DC	8 - Configurable 24V DC
Standard Analog Outputs	0	2 - Configurable (12 bit + sign, each ±V)	2 - Configurable (12 bit + sign, each ±V)	2 - Configurable (11 Bit + sign, each ±V)
Standard Digital Outputs	1 fixed 24V DC	3 fixed 24V DC	3 fixed 24V DC	4 configurable (24V DC) 2 configurable relay (N.O.)
Optional I/O	Discrete Adapter (4 digital inputs, 2 digital outputs, 4 analog inputs, 4 analog outputs) Digital Ref (1 fixed input, 10 digital inputs, 5 digital outputs, 2 analog inputs, 2 analog outputs)	2 analog outputs 2 analog inputs 5 fixed digital inputs 2 configurable digital outputs 1 pulse train input 1 pulse train output	2 analog outputs 2 analog inputs 5 fixed digital inputs 2 configurable digital outputs 1 pulse train input 1 pulse train output 120V AC external interface	2 configurable analog outputs 4 configurable digital inputs 4 configurable digital outputs 115V AC interface
Protection				
Motor OL Protection	Yes	Yes	Yes	Yes
Field Loss	Yes	Yes	Yes	Yes
Feedback Loss	Yes	Yes	Yes	Yes
Under & Over Voltage Protection	–	Yes	Yes	Yes
Dynamic Braking	Armature regen or dynamic braking resistor	Armature regen or dynamic braking resistor	Armature regen or dynamic braking resistor	Armature regen or dynamic braking resistor
Over Current	Yes	Yes	Yes	Yes
MOVs	Field bridge only	–	–	–

Table 1 - Drive Specification and Feature Comparisons (Continued)

Attributes	1395	1397	FlexPak 3000	PowerFlex DC
Input Power				
120V AC $\pm 10\%$	n/a	n/a	n/a	n/a
200...240V AC $\pm 10\%$	47...63 Hz	48...62 Hz	47...63 Hz	47...63 Hz
380...480V AC $\pm 10\%$	48...63 Hz	48...62 Hz	48...63 Hz	47...63 Hz
500...600V AC $\pm 10\%$	n/a	n/a	n/a	47...63 Hz
Single Phase	n/a	n/a	n/a	n/a
Three Phase	All	All	All	All
Input Inductor	3% required	3% required	3% recommended	3% recommended
Logic Ride-thru	–	–	–	0.5...2.0 s
Power Ride-thru	None	None	None	15 ms at full load
Extended Power Ride-thru	No	No	No	No
Transient Protection	MOV	–	–	–
Dynamic Braking	Optional	Optional	Optional	Optional
Output Power				
120V DC	n/a	n/a	n/a	n/a
240V DC	1...300 Hp	1.5...300 Hp	1.5...300 Hp	1.5...300 Hp
500V DC	2...600 Hp	3...600 Hp	3...600 Hp	2...900 Hp
600V DC	n/a	n/a	n/a	50...1250 Hp
700V DC	n/a	n/a	n/a	400...1400 Hp
Efficiency (100% Speed & Load)	–	99.30%	99.30%	–
Power Factor	88% @ max speed	88% @ max speed	88% @ max speed	Speed dependent
Output Power Device	SCR	SCR	SCR	SCR
Protection				
Ground Fault	–	No	No	Yes
Ground Warning	–	No	No	No
Current Limit	Yes	Yes	Yes	Yes
Over Current	Yes	Yes	Yes	Yes
Electronic Overload	Yes	No	–	–
Overload Meets NEC per UL	–	No	–	–
Speed Sensitive Overload	–	No	–	–
Enclosure				
Open / IP20	Yes	Yes	Yes	Yes

Table 1 - Drive Specification and Feature Comparisons (Continued)

Attributes	1395	1397	FlexPak 3000	PowerFlex DC
Certification				
U.L.	Yes	Yes	Yes	Yes
Canadian Standards (CSA)	Yes	Yes	Yes	Yes
CE - EMC (EN 50081-1)	No	No (has EN 50081-2)	–	–
CE - EMC (EN 50082-2)	No	No (has EN 50082-1)	–	–
CE - EMC (EN 61800-3)	No	No (has EN 292)	–	Yes
CE - LV (EN 50178)	No	No (has EN 1050)	–	Yes
CE - LV (EN 60204)	No	No (has EN 1037)	–	–
C-Tick	No	No	–	Yes
EMC Emission Levels				
2nd Environment	No	–	–	–
1st Environment / Class A	No	–	–	–
Class B	No	–	–	–
Programming/Control Panel				
Drive Display:	LCD	LCD	LCD	LCD
Lines and Characters	4x16	2x16	4x16	7x21
Start	Yes	Yes	Yes	Yes
Stop	Yes	Yes	Yes	Yes
Jog	Yes	Yes	Yes	Yes
Direction	Yes	Yes	Yes	Yes
Analog Potentiometer	No	Yes	No	Yes
Digital Inc./Dec.	Yes	Yes	Yes	Yes
Languages	1	5	4	1 (7 - firmware version 3.001 and later)
IP Ratings	20	20 / 54 / 66	–	20
Remote Display:	LCD	LCD	LCD	LCD
Lines and Characters	4x16	2x16	3x16	7x21
Process Display	Yes (3)	Yes (1)	Yes (1)	Yes (2)
Languages	1	5	4	1
Handheld Terminal	Yes	HIM/GPT	No	Use the drive display
Copy Cat Feature	No	Yes	No	Yes
Multiple Drive Control from 1 Unit	No	No	No	No
IP Ratings	20	20 / 54 / 66	–	20

Table 1 - Drive Specification and Feature Comparisons (Continued)

Attributes	1395	1397	FlexPak 3000	PowerFlex DC
Control Inputs				
Number of Control Terminals	51	32	32	48
Terminal Type	Fixed, screw type	Fixed, screw type	Fixed, screw type	Pull apart, screw type
Control Inputs	24V DC or 115V AC	24V DC or 115V AC (opt)	24V DC or 115V AC (opt)	24V DC or 115V AC (opt)
Programmable Control Inputs	5	0	1 standard, 5 optional	11
Jog Speeds (independent)	2	1	1	1
MOP Input	Yes	Yes (optional)	Yes (optional)	1
Pulse Train Input	Yes (optional)	Yes	Yes (optional)	No
Preset Speeds	5	3 (with I/O expansion)	3 (with I/O expansion)	7
Hardware Enable	Yes (E-Coast)	Yes (Coast Stop)	Yes (Coast Stop)	Yes (Coast Stop)
Safety Input	No	No	No	No
Signal Inputs				
Remote Speed Potentiometer	Yes	Yes	Yes	Yes
Voltage Input (DC)	0 ... ±10V	±10V	±10V	±10V
Current Input	n/a	4 ... 20 mA or 10 ... 50 mA	4 ... 20 mA or 10 ... 50 mA	0 ... 20 mA or 4 ... 20 mA
Analog Bipolar (ref & dir)	–	Yes	Yes	Yes
Analog Trim Function	–	Yes	Yes	Yes
Analog Signal Inversion	–	No	No	No
Analog Input Scaling	Scale and offset	Yes	Yes	Scale and offset
Control Outputs				
Relay Form A	3	3	3	2
Relay Form B	0	0	0	0
Relay Form C	0	0	0	0
Open Collector	n/a	n/a	n/a	4
Programmable Outputs	2	2 (optional)	2 (optional)	4 (standard), 4 (optional)
Signal Outputs				
Analog Outputs	(4) ±10V DC	(2) ±10V DC	(2) +/- 10V DC	2 (standard), 2 (optional) ±10V DC
Analog Output Scaling	Yes	Yes	Yes	Yes
Pulse Train Output	No	1 (optional)	1 (optional)	No
Analog Output Update Rate	6 ms	–	–	2 ms

Table 1 - Drive Specification and Feature Comparisons (Continued)

Attributes	1395	1397	FlexPak 3000	PowerFlex DC
Communication				
Drive Protocol		SCANport	Serial	DPI
Bluetooth		Yes	No	Yes
Remote I/O	Yes	Yes	No	Yes
Serial	Yes	232/422/485	232	232/485
DF1	Yes	Yes	No	Yes
DH485	No	Yes	No	No
DH+	Yes	No	No	No
BACNet	No	No	No	Yes
DeviceNet	No	Yes	Yes	Yes
ControlNet	Yes	Yes	Yes	Yes
EtherNet/IP	No	Yes	No	Yes
Profibus DP	No	No	Yes	Yes
Interbus S	No	No	Yes	Yes
Modbus RTU	No	No	No	Yes
Modbus/TCP	No	No	No	Yes
Metasys N2	No	No	No	Yes
Siemens P1	No	No	No	Yes
PC Software	DriveExecutive / DriveTools 32	DriveExplorer / DriveTools 32	CS3000	DriveExplorer / DriveExecutive / Connected Components Workbench
Features				
Analog Signal Loss Select	No	No	No	No
Application Macros/Function Blocks	No	No	No	No
Auto Restart (after power loss)	No	No	No	Yes
Droop	Yes	Yes	Yes	Yes
Fault Reset/Run	no	No	No	No
Field Economizer	Yes	With option	With option	Standard
Torque Taper (Field Weakening)	Yes	With option	With option	Standard
Ramp to Hold	No	No	No	No
Factory Default Reset	–	Yes	Yes	Yes
Flying Start	No	Yes	Yes	Yes
Program While Drive Running	Partial	Partial	Partial	Partial
S-curve Acc/Dec	Yes	Yes	Yes	Yes
Zero Speed Signal	Yes	Yes	Yes	Yes
Torque Proving	No	No	No	No
Winder	No	No	WebPak 3000	Yes
Trending	Yes	No	CS3000	DriveExecutive

Table 1 - Drive Specification and Feature Comparisons (Continued)

Attributes	1395	1397	FlexPak 3000	PowerFlex DC
Control Modes				
Closed Loop	Yes	Yes	Yes	Yes
Process Control	Speed	Speed	Speed	Speed
Process Control	Torque	Torque	Torque	Torque
Speed Profiles	No	No	No	Yes
Position Control	No	No	Yes	Yes
Droop	Yes	Yes	Yes	Yes
Speed/Torque switch-over	Yes	No	No	Yes
Speed/Torque MIN	Yes	No	No	Yes
Speed/Torque MAX	Yes	No	No	Yes
Speed/Torque SUM	Yes	No	No	Yes
Feedback Devices				
Encoder	Yes	Yes	Yes	Yes
DC Tachometer	Yes	Yes	Yes	Yes
Armature Feedback	Yes	Yes	Yes	Yes
Resolver	No	No	Yes	Yes
Motor Control				
Shunt Wound	Yes	Yes	Yes	Yes
Compound Wound	Yes	Yes	Yes	Yes
Series Wound	–	–	–	Non-regen only
Auto-tuning	Yes	Yes	Yes	Yes
Permanent Magnet	Yes	No	No	Yes
Speed Regulation				
Speed Regulation with Encoder	0.01% of set speed 0.001% of top speed	0.01% of top speed	0.01% of top speed	0.02% of set speed
Speed Regulation with DC Tachometer	0.5% of top speed (5PY) 0.1% of top speed (BC42)	1%	1%	0.1%
Speed Regulation with Armature Voltage	2% of top speed	2...3% of top speed	2...3% of top speed	2% of top speed
Operating Speed Range	–	–	–	–
Operating Speed Range with Encoder	1000:1 RPM	200:1	200:1	1000:1 RPM
Torque Regulation				
Performance Accuracy	2%	5%	–	1%
Speed Reference				
Speed Reference Digital Resolution	4096 PU Motor base/4096 = res Example: 1750/4096 = 0.427 RPM	32767 = Max Speed Example: max speed /32767 = res 1750/32767 = 0.053 RPM	–	0.25 RPM
Speed Ref Analog Resolution	11 bit	12 bit	–	15 bit
Max Speed	6 x Motor Base Speed	5000 RPM	–	8000 RPM

Table 1 - Drive Specification and Feature Comparisons (Continued)

Attributes	1395	1397	FlexPak 3000	PowerFlex DC
Speed Regulator				
Update Time	4 ms	20 ms	5 ms	2 ms (limited by analog input reference)
Speed Regulator Encoder				
Feedback Resolution	Encoder PPR	Encoder PPR	Encoder PPR	0.5 RPM
Speed Regulator Rad/Sec (max programmable)	150	140	140	170
Speed Regulation	0.00%	0.01%	0.01%	0.02%
Operating Range	1:100	1:100	1:100	1:1000
Encoder PPR	10...32767	18...2500	18...2500	100...32770
Speed Regulator Tachometer				
Feedback Resolution	12 bit A/D	12 bit A/D	12 bit A/D	1:2000
Speed Regulator Rad/Sec	150	140	140	170
Speed Regulation	0.10%	1%	1%	0.1%
Operating Range	1:100	1:100	1:100	1:1000
Speed Regulator Armature Feedback				
Feedback Resolution	12 bit	12 bit	12 bit	1:2000
Speed Regulator Rad/Sec	70	70	70	80
Speed Regulation	2.0%	2...3%	2...3%	2.0%
Operating Range	1:10	1:10	1:10	1:100
Current Regulator				
Current Resolution	12 bit	12 bit	12 bit	1:2000
Accuracy	–	–	–	1.0%
Bandwidth Rad/Sec	1000 max	200	200	500
Update Time	2 ms	2 ms	2 ms	250 μs

(1) This item has Silver Series status. For information, refer to www.ab.com/silver

Drive Catalog Number Explanations

Bulletin 1395 Digital DC Drive

The following tables are an explanation of the catalog numbering system for the 1395 DC drive and options.

Table 2 - 230V AC Input (1...100 Hp)

1395 -	A61 -		C1 -		P10 - X1	
First Position Bulletin No.	Second Position Horsepower		Third Position Contactur Type		Fourth Position Options	
1395	Non-Regenerative		Standard		Standard Options ⁽¹⁾⁽²⁾	
	<i>Code</i>	<i>Hp Rating</i>	<i>Code</i>	<i>Hp Rating</i>	<i>Code</i>	<i>Option</i>
	A61N	1 Hp	C1	1...15 Hp	P10	Discrete adapter 115 VAC (Port A)
	A62N	1.5 Hp	C2	20...30 Hp	P11	Discrete adapter 24VDC (Port A)
	A63N	2 Hp	C3	40...50 Hp	P12	Digital reference adapter (Port A)
	A64N	3 Hp	C4	60...75 Hp	P50	Node adapter (Port B)
	A65N	5 Hp	C5	100 Hp	P51	Multi-communication adapter (Port B)
	A66N	7.5 Hp			P54EN	ControlNet adapter board (Port A or B)
	A67N	10 Hp	Dynamic Braking		PZ	No adapter
	A68N	15 Hp	<i>Code</i>	<i>Hp Rating</i>		
	A69N	20 Hp	D1	1...15 Hp	Other Options	
	A70N	25 Hp	D2	20...30 Hp	<i>Code</i>	<i>Option</i>
	A71N	30 Hp	D3	40...50 Hp	X1	Auxiliary contact (1–N.O, 1–N.C.) ⁽³⁾
			D4	60...75 Hp		
			D5	100 Hp		
	Regenerative					
	<i>Code</i>	<i>Hp Rating</i>				
	A61	1 Hp				
	A62	1.5 Hp				
	A63	2 Hp				
	A64	3 Hp				
	A65	5 Hp				
	A66	7.5 Hp				
	A67	10 Hp				
	A68	15 Hp				
	A69	20 Hp				
	A70	25 Hp				
	A71	30 Hp				
	A72	40 Hp				
	A73	50 Hp				
	A74	60 Hp				
	A75	75 Hp				
	A76	100 Hp				

(1) Multiple options are separated by dashes.

(2) Limited to one adapter in port A and one adapter in Port B.

(3) Standard on 100 Hp drives.

Table 3 - 460V AC Input (2...200 Hp)

1395 -	B63 -		C1 -		P10 - X1	
First Position	Second Position		Third Position		Fourth Position	
Bulletin No.	Horsepower		Contacteur Type		Options	
1395	Non-Regenerative		Standard		Standard Options ⁽¹⁾⁽²⁾	
	<i>Code</i>	<i>Hp</i>	<i>Code</i>	<i>Hp</i>	<i>Code</i>	<i>Option</i>
	B63N	2 Hp	C1	2...30 Hp	P10	Discrete adapter 115 VAC (Port A)
	B64N	3 Hp	C2	40...60 Hp	P11	Discrete adapter 24VDC (Port A)
	B65N	5 Hp	C3	75...100 Hp	P12	Digital reference adapter (Port A)
	B66N	7.5 Hp	C4	125...150 Hp	P50	Node adapter (Port B)
	B67N	10 Hp	C5	200 Hp	P51	Multi-communication adapter (Port B)
	B68N	15 Hp			P54EN	ControlNet adapter board (Port A or B)
	B69N	20 Hp	Dynamic Braking		PZ	No adapter
	B70N	25 Hp	<i>Code</i>	<i>Hp</i>	Other Options	
	B71N	30 Hp	D1	2...30 Hp	<i>Code</i>	<i>Option</i>
	B72N	40 Hp	D2	40...60 Hp	X1	Auxiliary contact (1-N.O, 1-N.C.) ⁽³⁾
	B73N	50 Hp	D3	75...100 Hp		
	B74N	60 Hp	D4	125...150 Hp		
			D5	200 Hp		
	Regenerative					
	<i>Code</i>	<i>Hp</i>				
	B63	2 Hp				
	B64	3 Hp				
	B65	5 Hp				
	B66	7.5 Hp				
	B67	10 Hp				
	B68	15 Hp				
	B69	20 Hp				
	B70	25 Hp				
	B71	30 Hp				
	B72	40 Hp				
	B73	50 Hp				
	B74	60 Hp				
	B75	75 Hp				
	B76	100 Hp				
	B77	125 Hp				
	B78	150 Hp				
	B79	200 Hp				

(1) Multiple options are separated by dashes.

(2) Limited to one adapter in port A and one adapter in Port B.

(3) Standard on 200 Hp drives.

Table 4 - 230V AC Input (125...300 Hp)

1395 -	A77 -		E1 -		P30 - P50 - X2	
First Position Bulletin No.	Second Position Horsepower		Third Position Armature Shunt		Fourth Position Options	
1395	Non-Regenerative		<i>Code</i>	<i>Option</i>	Standard Options ⁽¹⁾⁽²⁾	
	<i>Code</i>	<i>Hp</i>	EN – No Shunt	EN – No Shunt	<i>Code</i>	<i>Option</i>
	A77N	125 Hp	E1	1000 A for 125 Hp	P30	Discrete adapter 115V AC (Port A)
	A78N	150 Hp	E2	1500 A for 150...200 Hp	P31	Discrete adapter 24V DC (Port A)
	A79N	200 Hp	E3	2000 A for 250...300 Hp	P32	Digital reference adapter 24V DC (Port A)
	A80N	250 Hp			P50	Node adapter (Port B)
	A81N	300 Hp			P52	Multi-communication adapter (Port B)
					P54EN	ControlNet adapter board (Port A or B)
	Regenerative				PZ	No adapter
	<i>Code</i>	<i>Hp</i>			X2	Lug kit
	A77	125 Hp				
	A78	150 Hp				
	A79	200 Hp				
	A80	250 Hp				
	A81	300 Hp				

(1) Multiple options are separated by dashes.
 (2) Limited to one adapter in port A and one adapter in Port B.

Table 5 - 460V AC Input (250...600 Hp)

1395 -	B82N -		E2 -		P30 - P50 - X2	
First Position Bulletin No.	Second Position Horsepower		Third Position Armature Shunt		Fourth Position Options	
1395	Non-Regenerative		<i>Code</i>	<i>Option</i>	Standard Options ⁽¹⁾⁽²⁾	
	<i>Code</i>	<i>Hp</i>	EN – No Shunt	EN – No Shunt	<i>Code</i>	<i>Option</i>
	B80N	250 Hp	E1	1000 A for 250 Hp	P30	Discrete adapter 115V AC (Port A)
	B81N	300 Hp	E2	1500 A for 300...400 Hp	P31	Discrete adapter 24V DC (Port A)
	B82N	400 Hp	E3	2000 A for 500...600 Hp	P32	Digital reference adapter 24V DC (Port A)
	B83N	500 Hp			P50	Node adapter (Port B)
	B84N	600 Hp			P52	Multi-communication adapter (Port B)
					P54EN	ControlNet adapter board (Port A or B)
	Regenerative				PZ	No adapter
	<i>Code</i>	<i>Hp</i>			X2	Lug kit
	B80	250 Hp				
	B81	300 Hp				
	B82	400 Hp				
	B83	500 Hp				
	B84	600 Hp				

(1) Multiple options are separated by dashes.
 (2) Limited to one adapter in port A and one adapter in Port B.

Bulletin 1395 Digital DC Drive in Bulletin 2361 Motor Control Centers

The following tables are an explanation of the catalog numbering system for the 1395 DC drive in a 2361 Motor Control Center (MCC) and the available options.

Table 6 - Bulletin 2361 MCC Units

Bulletin No.	Unit Type	Wiring Type	Module Size	Enclosure	AC Input Line Voltage	Hp	Trip Device	Options
2361	F	A	S	A	C	68	CM	XXX
2361	E - Regenerative F - Non-Regenerative ⁽¹⁾	A - Type power wiring ⁽²⁾	R = 1250 A S = 1650 A T = 3000 A	A = NEMA/UL Type 1 without gaskets and door fan filters J = NEMA/UL Type 1 with gaskets and door fan filters	B = 460V AC C = 575V AC ⁽³⁾ G = 660V AC	64 = 700 Hp 65 = 750 Hp 66 = 800 Hp 67 = 900 Hp 68 = 1000 Hp 69 = 1250 Hp 70 = 1500 Hp 71 = 1750 Hp 72 = 2000 Hp 73 = 2250 Hp 74 = 2500 Hp	CM = High AIC instantaneous trip circuit breaker with thermal magnetic plug / trip function LF = Line fuses only	⁽⁴⁾

- (1) Non-regenerative units not offered for 3000A modules.
- (2) Units accommodate top entry and bottom exit. An additional section is required for bottom entry and a separate additional section is required for top exit.
- (3) Units configured for 575V or 660V AC inputs require field transformers. The field supply modules require an input voltage of 460V AC and the field transformer is utilized to step-down 575V or 660V AC inputs to 460V AC. The base unit price of a 575V or 660V AC input drive includes a field transformer (and fusing) that provides up to 18A to the field supply module. Select a field transformer upgrade option when you need to supply more current to the field supply module. All field transformers come standard in a NEMA/UL Type 1 enclosure. Nominal field currents based on 85% efficiency, unit control power usage, and a 300V field supply.
- (4) Add option codes here separated with dashes. For example 4R-1B-3. See [Table 7](#) - Bulletin 1395 in Bulletin 2361 MCC Options for option codes and descriptions.

Table 7 - Bulletin 1395 in Bulletin 2361 MCC Options

Option	Code	Description
Door-mounted Pilot Light ⁽¹⁾	4R	Power-on
Door-mounted Push Buttons ⁽¹⁾	1B	Drive stop ⁽⁴⁾
	1JF	Jog forward ⁽⁴⁾
	1JR	Jog reverse ⁽⁴⁾
	1ES	Hard-wired stop interface
Door-mounted Illuminated Push Buttons ⁽¹⁾⁽⁴⁾	5G	start / Running ⁽¹⁰⁾
	5A	Clear faults / Drive faulted
Door-mounted Switches ⁽¹⁾⁽⁴⁾	3	Speed 0-1-2 selector
	760A	Single-turn speed pot
Drive Port A Cards ⁽²⁾	14DAA	Discrete adapter, 115V AC
	14DAD	Discrete adapter, 24V DC with 0.5 A, 24V DC power supply
	14DRA	Digital reference adapter, 24V DC with 0.5 A, 24V DC power supply
Drive Port B Cards ⁽²⁾	14CN	ControlNet adapter
	14NA	Node adapter
	14MCA	Multi-communication adapter
Tachometer Feedback Scaling Boards ⁽³⁾	14T033	Scaling board for resolvers with 0...33V DC output voltage
	14T046	Scaling board for resolvers with 34...46V DC output voltage
	14T070	Scaling board for resolvers with 47...70V DC output voltage
	14T125	Scaling board for resolvers with 71...125V DC output voltage
	14T178	Scaling board for resolvers with 126...178V DC output voltage
	14T250	Scaling board for resolvers with 179...250V DC output voltage
Configuration Terminals ⁽⁴⁾	766	Door-mounted D-shell connector
	766A	Door-mounted DHT (standard terminal)
	766B	Door-mounted EHT (enhanced terminal)
Control Power Source ⁽⁵⁾	6P	Standard capacity control transformer with primary fusing
	6TB	115V AC control power, factory wired from 115V AC control bus to drive unit
	6SC	115V AC control power supplied by customer
Dynamic Braking Contactor ⁽⁶⁾	14DB	Dynamic braking contactor option
Unit Door Nameplates ⁽⁵⁾	M3EW	White background with black lettering; phenolic label
	N3EB	Black background with white lettering; phenolic label
	N3ER	Red background with white lettering; phenolic label
Auxiliary Contacts	989X	Two normally open and two normally closed contactors, mounted internally if 1250/1650 A unit OR Four normally open and four normally closed contactors, mounted internally if 3000 A unit

Table 7 - Bulletin 1395 in Bulletin 2361 MCC Options

Option	Code	Description
Blower Starters ⁽⁴⁾	14BN	One NEMA size 1 full-voltage, non-reversing (FVNR) starter assembly with 30 A fuse blocks mounted within the drive unit
	14B2N	Two NEMA size 1 FVNR starter assemblies with 30 A fuse blocks mounted within the drive unit
	14B2NX	Two NEMA size 2 FVNR starter assemblies with 60 A fuse blocks mounted within the drive unit
	14BI	One IEC, 24 A starter assembly mounted with 30 A fuse blocks within the drive unit
	14B2I	Two IEC, 24 A starter assemblies mounted with 30 A fuse blocks within the drive unit
	14B2IX	Two IEC, 30 A starter assemblies mounted with 60 A fuse blocks within the drive unit
Protection	14LSP	Line RC suppressor module ⁽¹¹⁾
	14AFL	Air flow loss switches
Input Option ⁽⁷⁾	14HBC	AC power input is wired from the horizontal thru-bus to the circuit breaker
Field Supply Upgrade ⁽⁸⁾	14FX	Field supply upgrade for fields requiring 43...90 A
Field Voltage Step-down Options for Units with 575 or 660V AC Input ⁽⁹⁾	14SD28	Field transformer for field currents up to 28 A
	14SD40	Field transformer for field currents up to 40 A
	14SD90	Field transformer for field currents up to 90 A
Miscellaneous	14WLBL	Brady Datab wire labels ⁽¹²⁾
	J12	115V DC, 15 A duplex receptacle, customer-wired ⁽¹³⁾
	J11	Audio phone jack

(1) Devices are 800T-type.

(2) Maximum number of cards allowed is one for Port A, and one for Port B.

(3) If your motor has a DC tachometer, select the appropriate scaling board.

(4) You may select one option from this group.

(5) You must select one option from this group.

(6) For 1250...3000 A modules, you may select option "14DB." This option includes a dynamic braking contactor mounted in a separate 20 in. MCC section.

(7) This option is only valid for 1250 A and 1650 A DC drives. You must specify an AC thru-bus option with a current capacity larger than the continuous input current rating of the drive unit.

(8) Units come standard with a field supply module rated to supply field currents up to 43 A. This field supply option allows you to supply up to 90 A to the motor field. If you are selecting a 575V or 660V AC input and this field supply option, you must select field voltage step-down option "14SD90".

(9) Units configured for 575V or 660V AC input require field transformers. The field supply modules require an input voltage of 460V AC and the field transformer is utilized to step-down 575V or 660V AC input to 460V AC. The base unit price of a 575V or 660V AC input drive includes a field transformer (and fusing) that provides up to 18 A to the field supply module. Select a field transformer upgrade option when you need to supply more current to the field supply module. All field transformers come standard in a NEMA/UL Type 1 enclosure. Nominal field currents based on 85% efficiency, unit control power usage, and a 300V field supply.

(10) If selected, you must also select option "1B."

(11) The line RC suppressor is recommended for installations where the primary of the distribution transformer is 2300V AC or greater.

(12) Units come standard with cloth wire labels. Datab labels offer the added protection of a clear plastic cover on top of the labels.

(13) Customer supplies 115V AC control power and wiring to the duplex receptacle.

Bulletin 1397 Digital DC Drive

The following tables are an explanation of the catalog numbering system for the 1397 DC drive and options.

Table 8 - Bulletin 1397 - All Drives

1397 -	B		005		R		- XXX
First Position Bulletin No.	Second Position Voltage		Third Position Rating		Fourth Position Type		Fifth Position Options ⁽²⁾
1397	<i>Code</i>	<i>AC Input Voltage</i>	<i>Code</i>	<i>Hp (kW) Rating</i>	<i>Code</i>	<i>Type</i>	
	A	230V	001	1.5 (1.1)	N	Non-Regenerative	
			002	2 (1.5)	R	Regenerative ⁽¹⁾	
			003	3 (2.2)			
			005	5 (3.7)			
			007	7.5 (5.8)			
			010	10 (7.5)			
			015	15 (11)			
			020	20 (15)			
			025	25 (18)			
			030	30 (22)			
			040	40 (29)			
			050	50 (37)			
			060	60 (44)			
			075	75 (55)			
			100	100 (74)			
			125	125 (93)			
			150	150 (111)			
	<i>Code</i>	<i>AC Input Voltage</i>	<i>A DC</i>	<i>Hp (kW) Rating</i>			
	U	380/415V	7	2.4 (1.8) / 2.8 (2.1)			
			29	12 (9) / 13.8 (10.3)			
			55	24 (17.9) / 27.6 (20.8)			
			110	48 (35.8) / 55.2 (41.2)			
			265	120 (89.5) / 138 (102.9)			

Table 8 - Bulletin 1397 - All Drives

1397 -	B		005		R		- XXX
First Position Bulletin No.	Second Position Voltage		Third Position Rating		Fourth Position Type		Fifth Position Options ⁽²⁾
1397	Code	AC Input Voltage	Code	Hp (kW) Rating	Code	Type	
	B	460V	003	3 (2.2)	N	Non-Regenerative	
			005	5 (3.7)	R	Regenerative ⁽¹⁾	
			007	7.5 (5.6)			
			010	10 (7.5)			
			015	15 (11)			
			020	20 (15)			
			025	25 (18)			
			030	30 (22)			
			040	40 (29)			
			050	50 (37)			
			060	60 (44)			
			075	75 (55)			
			100	100 (74)			
			125	125 (93)			
			150	150 (111)			
			200	200 (149)			
			250	250 (186)			
			300	300 (224)			
			400	400 (298)			
			500	500 (373)			
			600	600 (448)			

(1) Regenerative (R) required for reversing applications.

(2) See [Table 9](#) - Bulletin 1397 Options for details.

Table 9 - Bulletin 1397 Options

Code	Description
Control Options	
-DS	AC line disconnect
-MB	Blower motor starter
-L10	Control interface – 115VAC
-L11	I/O expansion card
-DB	Dynamic braking
-FS2	Enhanced field supply
-FS3	Field current regulator
-PE	Pulse encoder kit
-AC	AC tachometer kit
-IFB	400 . . . 600 Hp only

Table 9 - Bulletin 1397 Options

Code	Description
Communication Options (Loose Kits)	
-1203-GD1	Single point remote I/O (RIO) – 115V AC
-1203-GD2	RS-232/422/485, DF1 and DH485 protocol – 115VAC
-1203-GK1	Single point remote I/O (RIO) – 24 VDC
-1203-GK2	RS-232 interface board
-1203-GK5	DeviceNet – 24 VDC
Human Interface Options	
-HAB	Blank – No functionality
-HAP	Programmer only
-HA1	Programmer / Controller with analog pot
-HA2	Programmer / Controller with digital pot

FlexPak 3000 Digital DC Drive

Drive specific data, such as horsepower (or output current), regenerative or non-regenerative type, line voltage, chassis or enclosure type, software version and UL certification, can be determined by the drive model number. The model number structure is shown in [Table 10](#).

Table 10 - FlexPak 3000 Drives

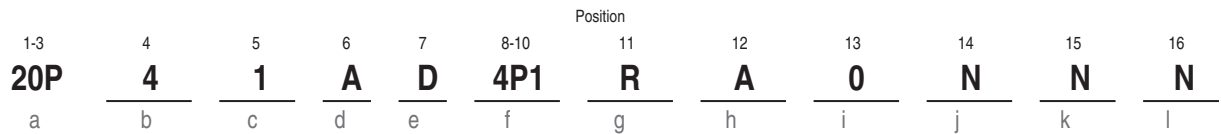
150	F	R	4	0	4	2
First Position	Second Position	Third Position	Fourth Position	Fifth Position	Sixth Position	Seventh Position
For horsepower-rated drives: Horsepower under 1000 For current-rated drives: Rated output armature current	F FlexPak 3000	B Regenerative drive with an inverting fault breaker	2 230 Volts	0 Chassis	0...9, A...Z Software version number	0 No listing
		R Regenerative drive	3 380/415V	7 Integrator	1 U/L and C-U/L	
		N Non-Regenerative drive	4 460V	2 U/L, C-U/L, and CE		
		K Kit	7 Integrator			
			8 European power module			

This table lists the option kits that broaden the application range of the FlexPak 3000 drive. Not all kits can be used with all drive model numbers.

Table 11 - FlexPak 3000 Drive Options

Option Name	Description	Model Number
115V AC Control Interface	Converts customer-supplied 115V AC signals to 24V DC for operating a FlexPak 3000. Mounts separately on the panel or can be mounted in the bottom of a NEMA 1 enclosed drive.	917FK0101
460V AC to 230V AC Conversion Kit	Converts a 460V AC FlexPak 3000 to a 230V AC FlexPak 3000 at one-half the 460V AC horsepower rating.	916FK series
AC Line Disconnect Kit	Allows for the three-phase line to be disconnected at the drive. Molded case switch that mounts on the chassis of the drive or NEMA/UL Type 1 enclosure.	901FK series
AC Tachometer Feedback Kit	Allows the FlexPak 3000 to accept feedback signals from AC tachometers to a maximum voltage of 275 VAC RMS.	907FK0301
AutoMax Network Communication Board	Allows the FlexPak 3000 to communicate on the Reliance AutoMax Distributed Control System (DCS).	915FK0101
Blower Motor Starter Kit	Provides a fused AC starter with adjustable overload and interlocking for control of the three phase blower motor used to cool the DC motor.	902FK series
DeviceNet Communication Board	Allows a FlexPak 3000 to communicate over the open protocol DeviceNet network. Mounts inside the FlexPak 3000 and includes terminals for network connections. You cannot use the AutoMax Network Communication board when using the DeviceNet board.	915FK1100
Drive Control Configuration Software for FlexPak 3000	Windows-based software that allows the user to connect any personal computer running Microsoft Windows® version 3.1 or later to a FlexPak 3000 drive. Allows you to create, store, upload, and download drive configurations. You can also start and stop the drive, monitor and change parameters through the PC, and read and reset the drive's fault log.	2CS3000
ControlNet Network Communication Board	Allows a FlexPak 3000 to communicate over the ControlNet network.	915FK2101
Dynamic Braking Kit	Provides the hardware, including braking grids, needed to provide dynamic braking on stop.	908FK, 909FK, 912FK, and 913FK series
Enhanced Field Supply Kit	Provides electronic field trim, field economy, and the ability to supply 240V field voltage and other special voltages. This kit replaces the standard field supply.	923FK series
Field Current Regulator Kit	Provides field economy, as well as pre-weakening of the field using a fixed reference or field weakening for above base speed operation. Tachometer feedback is required with this kit. This kit replaces the standard field supply.	911FK series
I/O Expansion Board	Mounts on the FlexPak 3000 chassis and gives the FlexPak 3000 additional analog, frequency, and digital I/O capability.	914FK0101
Inverting Fault Circuit Breaker Kit	This kit is an alternative to drives supplied with inverting fault fuses.	906FK series
NEMA 1 Conversion Kit	Converts the standard chassis to a NEMA/UL Type 1 enclosure.	904FK series
Operator Interface Module (OIM) Remote Mounting Kit	Allows mounting of the OIM up to five meters from the drive.	905FK0101
Pulse Encoder Feedback Kit	Allows for digital pulse encoder speed feedback.	907FK0101

PowerFlex Digital DC Drive



a

Drive	
Code	Type
20P	PowerFlex DC

b

Motor Operation	
Code	Type
2	Two Quadrant Operation *
4	Four Quadrant Operation

* Not available for 230V AC input drives.

c

Input Type	
Code	Type
1	6 Pulse

d

Enclosure		
Code	Enclosure Rating	Conform. Coat
A	IP20, NEMA/UL Type Open	Yes *

* Drives manufactured after October 2012 only.

e

Input Voltage	
Code	Voltage
B	230V AC
D	460V AC *
E	600V AC
F	690V AC

* Use this code for 400V AC input applications.

f1

230V, 60 Hz Input					
Code	Hp	kW	Armature Amps	Frame	Field Amps
7P0	1.5	1.2	7	A	10
9P0	2	1.5	9	A	10
012	3	2.2	12	A	10
020	5	3.7	20	A	10
029	7.5	5.5	29	A	10
038	10	7.5	38	A	10
055	15	11	55	A	10
073	20	15	73	A	14
093	25	18.5	93	A	14
110	30	22	110	A	14
146	40	30	146	B	20
180	50	37	180	B	20
218	60	45	218	B	20
265	75	56	265	B	20
360	100	75	360	B	20
434	125	93	434	B	20
521	150	112	521	C	20
700	200	149	700	C	20
875	250	186	875	D	40
1K0	300	224	1050	D	40

f2

460V, 60 Hz Input					
Code	Hp	kW	Armature Amps	Frame	Field Amps
4P1	2	1.5	4.1	A	10
6P0	3	2.2	6	A	10
010	5	3.7	10	A	10
014	7.5	5.5	14	A	10
019	10	7.5	19	A	10
027	15	11	27	A	10
035	20	15	35	A	10
045	25	18.5	45	A	10
052	30	22	52	A	10
073	40	30	73	A	14
086	50	37	86	A	14
100	60	45	100	A	14
129	75	56	129	A	14
167	100	75	167	B	20
207	125	93	207	B	20
250	150	112	250	B	20
330	200	149	330	B	20
412	250	187	412	B	20
495	300	224	495	C	20
667	400	298	667	C	20
830	500	373	830	D	40
996	600	447	996	D	40
1K1	700	552	1162	D	70
1K3	800	597	1238	D	70
1K4	900	671	1494	D	70

f3

575V, 60 Hz Input					
Code	Hp	kW	Armature Amps	Frame	Field Amps
067	50	37	67.5	B	20
101	75	56	101.3	B	20
135	100	75	135	B	20
270	200	149	270	B	20
405	300	224	405	B	20
540	400	298	540	C	20
675	500	373	675	C	20
810	600	447	810	D	40
1K0	800	597	1080	D	40
1K2	900	671	1215	D	40
1K3	1000	746	1350	D	40
1K6	1250	932	1668	D	40

f4

690V, 60 Hz Input					
Code	Hp	kW	Armature Amps	Frame	Field Amps
452	400	298	452	C	20
565	500	373	565	C	20
678	600	447	678	D	40
791	700	552	791	D	40
904	800	597	904	D	40
1K0	900	671	1017	D	40
1K1	1000	746	1130	D	70
1K2	1100	820	1243	D	70
1K4	1250	932	1413	D	70
1K5	1400	1044	1582	D	70

PowerFlex Digital DC Drive, Continued

1-3			4	5	6	7	8-10	11	12	13	14	15	16
a			b	c	d	e	f	g	h	i	j	k	l
20P			4	1	A	D	4P1	R	A	0	N	N	N

g	
Field Supply	
Code	Type
R	Single-Phase Regulated

h		
Packaging/Documentation		
Code	Shipping Carton	User Manual
A	Yes	Yes

i	
HIM	
Code	Operator Interface
0	Blank Cover *

* Standard - for additional selections, refer to the PowerFlex Digital DC Drive Technical Data, publication 20P-TD001...

j	
I/O Options *	
Code	Control
N	None (8 - 24V DC Digital Inputs, 4 Digital Outputs, 3 Analog Outputs, and 2 Analog Inputs are Standard)

* All I/O Options are purchased separately and are user installed.

k	
Communication Options	
Code	Description
N	None *

* Standard - for additional selections, refer to the PowerFlex Digital DC Drive Technical Data, publication 20P-TD001...

l	
Cabinet Options	
Code	Type
N	None

Drive Conversion Guides

The following tables compare rating codes, kilowatt and horsepower ratings, and armature DC output amps to assist you in migrating your 1395, 1397, or FlexPak 3000 drive to a comparable PowerFlex DC drive. See the table corresponding to your existing DC drive.

IMPORTANT The tables below list the drives on a direct Amps-to-Amps comparison. If your application requires a specific drive overload capability, please see Overload Capabilities in [Table 1](#) on page 10 for details and size your replacement drive accordingly.

Bulletin 1395 to PowerFlex DC Drive Conversions

230V AC Input Drives

1395			PowerFlex DC		
Cat. No.	Power Output kW (Hp)	Armature DC Output (Amps)	Cat. No.	Power Output kW (Hp)	Armature DC Output (Amps)
A61 & A61N	0.75 (1)	4.7	B7P0	1.2 (1.5)	7
A62 & A62N	1.2 (1.5)	6.6	B7P0	1.2 (1.5)	7
A63 & A63N	1.5 (2)	8.5	B9P0	1.5 (2)	9
A64 & A64N	2.2 (3)	12.2	B012	2.2 (3)	12
A65 & A65N	3.7 (5)	20	B020	3.7 (5)	20
A66 & A66N	5.6 (7.5)	29	B029	5.6 (7.5)	29
A67 & A67N	7.5 (10)	38	B038	7.5 (10)	38
A68 & A68N	11.2 (15)	55	B055	11.2 (15)	55
–	–	–	B073	15 (20)	73
A69 & A69N	15 (20)	80	B093	18.7 (25)	93
A70 & A70N	18.7 (25)	98	B110	22.4 (30)	110
A71 & A71N	22.4 (30)	110	B110	22.4 (30)	110
A72	29.9 (40)	140	B146	29.9 (40)	146
A73	37.3 (50)	180	B180	37.3 (50)	180
A74	44.8 (60)	210	B218	44.8 (60)	218
A75	56 (75)	260	B265	56 (75)	265
A76	74.6 (100)	345	B360	74.6 (100)	360
–	–	–	B434	93.3 (125)	434
A77 & A77N	93.3 (125)	472	B521	112 (150)	521
A78 & A78N	112 (150)	564	B700	149.2 (200)	700
A79 & A79N	149.2 (200)	670	B700	149.2 (200)	700
–	–	–	B875	186.5 (250)	875
A80 & A81N	186.5 (250)	918	B1K0	223.8 (300)	1050
A81 & A81N	223.8 (300)	980	B1K0	223.8 (300)	1050

460V AC Input Drives

1395			PowerFlex DC		
Cat. No.	Power Output kW (Hp)	Armature DC Output (Amps)	Cat. No.	Power Output kW (Hp)	Armature DC Output (Amps)
B63 & B63N	1.5 (2)	4.1	D4P1	1.5 (2)	4.1
B64 & B64N	2.24 (3)	5.9	D6P0	2.24 (3)	6
B65 & B65N	3.75 (5)	9.6	D010	3.75 (5)	10
B66 & B66N	5.6 (7.5)	13.9	D014	5.6 (7.5)	14
B67 & B67N	7.5 (10)	18.3	D019	7.5 (10)	19
–	–	–	D027	11.2 (15)	27
B68 & B68N	11.2 (15)	28	D035	15 (20)	35
B69 & B69N	15 (20)	36	D045	18.7 (25)	45
B70 & B70N	18.7 (25)	45	D045	18.7 (25)	45
B71 & B71N	22.4 (30)	51	D052	22.4 (30)	52
B72 & B72N	29.9 (40)	67.2	D073	29.9 (40)	73
–	–	–	D086	37.3 (50)	86
B73 & B73N	37.3 (50)	88	D100	44.8 (60)	100
B74 & B74N	44.8 (60)	106	D129	56 (75)	129
B75	56 (75)	140	D167	74.6 (100)	167
B76	74.6 (100)	180	D207	93.3 (125)	207
B77	93.3 (125)	210	D250	112 (150)	250
B78	112 (150)	260	D330	149.2 (200)	330
B79	149.2 (200)	345	D412	186.5 (250)	412
B80 & B80N	186.5 (250)	442	D495	223.8 (300)	495
B81 & B81N	223.8 (300)	529	D667	298.4 (400)	667
B82 & B82N	298.4 (400)	670	D830	373 (500)	830
B83 & B83N	373 (500)	913	D996	448 (600)	996
B84 & B84N	448 (600)	980	D996	448 (600)	996
–	–	–	D1K1	522.2 (700)	1162
–	–	–	D1K3	596.8 (800)	1328
–	–	–	D1K4	671.4 (900)	1494

Bulletin 1397 to PowerFlex DC Drive Conversions

230V AC Input Drives

1397			PowerFlex DC		
Cat. No.	Power Output Hp (kW)	Armature DC Output (Amps)	Cat. No.	Power Output kW (Hp)	Armature DC Output (Amps)
A001	1.5 (1.1)	7	B7P0	1.2 (1.5)	7
A002	2 (1.5)	9	B9P0	1.5 (2)	9
A003	3 (2.2)	12	B012	2.2 (3)	12
A005	5 (3.7)	20	B020	3.7 (5)	20
A007	7.5 (5.8)	29	B029	5.6 (7.5)	29
A010	10 (7.5)	38	B038	7.5 (10)	38
A015	15 (11)	55	B055	11.2 (15)	55
A020	20 (15)	73	B073	15 (20)	73
A025	25 (18)	93	B093	18.7 (25)	93
A030	30 (22)	110	B110	22.4 (30)	110
A040	40 (29)	146	B146	29.9 (40)	146
A050	50 (37)	180	B180	37.3 (50)	180
A060	60 (44)	218	B218	44.8 (60)	218
A075	75 (55)	265	B265	56 (75)	265
A100	100 (74)	360	B360	74.6 (100)	360
A125	125 (93)	434	B434	93.3 (125)	434
A150	150 (111)	521	B521	112 (150)	521
–	–	–	B700	149.2 (200)	700
–	–	–	B700	149.2 (200)	700
–	–	–	B875	186.5 (250)	875
–	–	–	B1K0	223.8 (300)	1050

460V AC Input Drives

1397			PowerFlex DC		
Cat. No.	Power Output Hp (kW)	Armature DC Output (Amps)	Cat. No.	Power Output kW (Hp)	Armature DC Output (Amps)
–	–	–	D4P1	1.5 (2)	4.1
B003	3 (2.2)	6	D6P0	2.24 (3)	6
B005	5 (3.7)	10	D010	3.75 (5)	10
B007	7.5 (5.6)	14	D014	5.6 (7.5)	14
B010	10 (7.5)	19	D019	7.5 (10)	19
B015	15 (11)	27	D027	11.2 (15)	27
B020	20 (15)	35	D035	15 (20)	35
B025	25 (18)	45	D045	18.7 (25)	45
B030	30 (22)	52	D052	22.4 (30)	52
B040	40 (29)	73	D073	29.9 (40)	73
B050	50 (37)	86	D086	37.3 (50)	86
B060	60 (44)	100	D100	44.8 (60)	100
B075	75 (55)	129	D129	56 (75)	129
B100	100 (74)	167	D167	74.6 (100)	167
B125	125 (93)	207	D207	93.3 (125)	207
B150	150 (111)	250	D250	112 (150)	250
B200	200 (149)	330	D330	149.2 (200)	330
B250	250 (186)	412	D412	186.5 (250)	412
B300	300 (224)	495	D495	223.8 (300)	495
B400	400 (298)	667	D667	298.4 (400)	667
B500	500 (373)	800	D830	373 (500)	830
B600	600 (448)	960	D996	448 (600)	996
–	–	–	D1K1	522.2 (700)	1162
–	–	–	D1K3	596.8 (800)	1328
–	–	–	D1K4	671.4 (900)	1494

380 / 415V AC Input Drives

1397			PowerFlex DC		
Cat. No.	Power Output Hp (kW)	Armature DC Output (Amps)	Cat. No.	Power Output kW (Hp)	Armature DC Output (Amps)
U7	1.8 (2.4) / 1.8 (2.4)	7	D010	3.75 (5)	10
U29	9 (12) / 10.3 (13.6)	29	D035	15 (20)	35
U55	17.9 (24) / 20.6 (27.6)	55	D073	29.9 (40)	73
U110	35.8 (48) / 41.2 (55.2)	110	D129	56 (75)	129
U265	89.5 (120) / 102.9 (138)	265	D330	149.2 (200)	330

FlexPak 3000 to PowerFlex DC Drive Conversions

230V AC Input Drives

FlexPak 3000			PowerFlex DC		
Cat. No.	Power Output Hp (kW)	Armature DC Output (Amps)	Cat. No.	Power Output kW (Hp)	Armature DC Output (Amps)
001**2	1.5 (1.1)	7	B7P0	1.2 (1.5)	7
002**2	2 (1.5)	9	B9P0	1.5 (2)	9
003**2	3 (2.2)	12	B012	2.2 (3)	12
005**2	5 (3.7)	20	B020	3.7 (5)	20
007**2	7.5 (5.8)	29	B029	5.6 (7.5)	29
010**2	10 (7.5)	38	B038	7.5 (10)	38
015**2	15 (11)	55	B055	11.2 (15)	55
020**2	20 (15)	73	B073	15 (20)	73
025**2	25 (18)	93	B093	18.7 (25)	93
030**2	30 (22)	110	B110	22.4 (30)	110
040**2	40 (29)	146	B146	29.9 (40)	146
050**2	50 (37)	180	B180	37.3 (50)	180
060**2	60 (44)	218	B218	44.8 (60)	218
075**2	75 (55)	265	B265	56 (75)	265
100**2	100 (74)	360	B360	74.6 (100)	360
125**2	125 (93)	434	B434	93.3 (125)	434
150**2	150 (111)	521	B521	112 (150)	521
–	–	–	B700	149.2 (200)	700
–	–	–	B700	149.2 (200)	700
–	–	–	B875	186.5 (250)	875
–	–	–	B1K0	223.8 (300)	1050

460V AC Input Drives

FlexPak 3000			PowerFlex DC		
Cat. No.	Power Output Hp (kW)	Armature DC Output (Amps)	Cat. No.	Power Output kW (Hp)	Armature DC Output (Amps)
–	–	–	D4P1	1.5 (2)	4.1
003**4	3 (2.2)	6	D6P0	2.24 (3)	6
005**4	5 (3.7)	10	D010	3.75 (5)	10
007**4	7.5 (5.6)	14	D014	5.6 (7.5)	14
010**4	10 (7.5)	19	D019	7.5 (10)	19
015**4	15 (11)	27	D027	11.2 (15)	27
020**4	20 (15)	35	D035	15 (20)	35
025**4	25 (18)	45	D045	18.7 (25)	45
030**4	30 (22)	52	D052	22.4 (30)	52
040**4	40 (29)	73	D073	29.9 (40)	73

FlexPak 3000			PowerFlex DC		
Cat. No.	Power Output Hp (kW)	Armature DC Output (Amps)	Cat. No.	Power Output kW (Hp)	Armature DC Output (Amps)
050**4	50 (37)	86	D086	37.3 (50)	86
060**4	60 (44)	100	D100	44.8 (60)	100
075**4	75 (55)	129	D129	56 (75)	129
100**4	100 (74)	167	D167	74.6 (100)	167
125**4	125 (93)	207	D207	93.3 (125)	207
150**4	150 (111)	250	D250	112 (150)	250
200**4	200 (149)	330	D330	149.2 (200)	330
250**4	250 (186)	412	D412	186.5 (250)	412
300**4	300 (224)	495	D495	223.8 (300)	495
400**4	400 (298)	667	D667	298.4 (400)	667
500**4	500 (373)	800	D830	373 (500)	830
600**4	600 (448)	960	D996	448 (600)	996
–	–	–	D1K1	522.2 (700)	1162
–	–	–	D1K3	596.8 (800)	1328
–	–	–	D1K4	671.4 (900)	1494

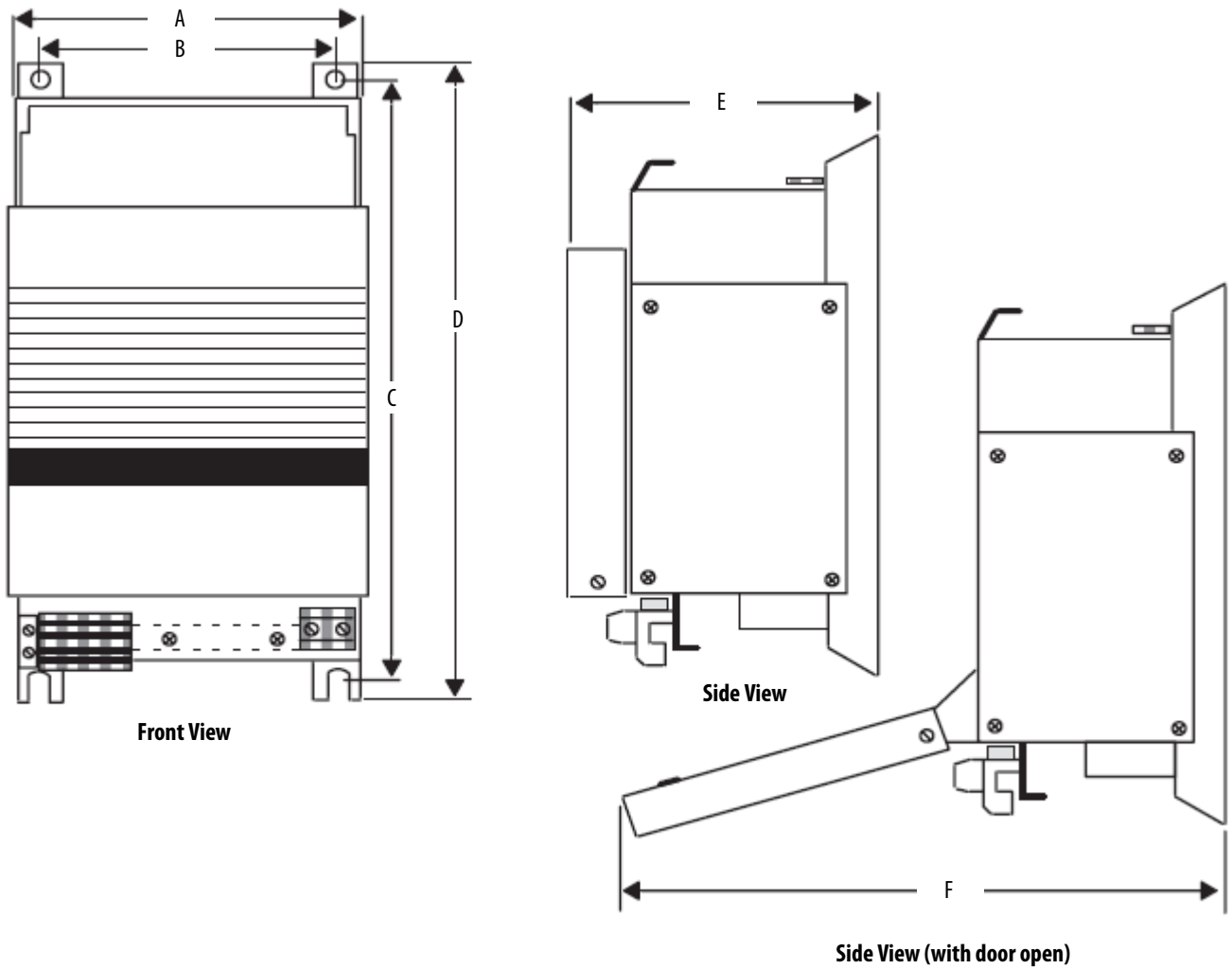
380/415V AC Input Drives

FlexPak 3000			PowerFlex DC		
Cat. No.	Power Output Hp (kW)	Armature DC Output (Amps)	Cat. No.	Power Output kW (Hp)	Armature DC Output (Amps)
007**3	1.8 (2.4) / 1.8 (2.4)	7	D10	3.75 (5)	10
029**3	9 (12) / 10.3 (13.6)	29	D35	15 (20)	35
055**3	17.9 (24) / 20.6 (27.6)	55	D73	29.9 (40)	73
110**3	35.8 (48) / 41.2 (55.2)	110	D129	56 (75)	129
265**3	89.5 (120) / 102.9 (138)	265	D330	149.2 (200)	330

Drive Dimensions

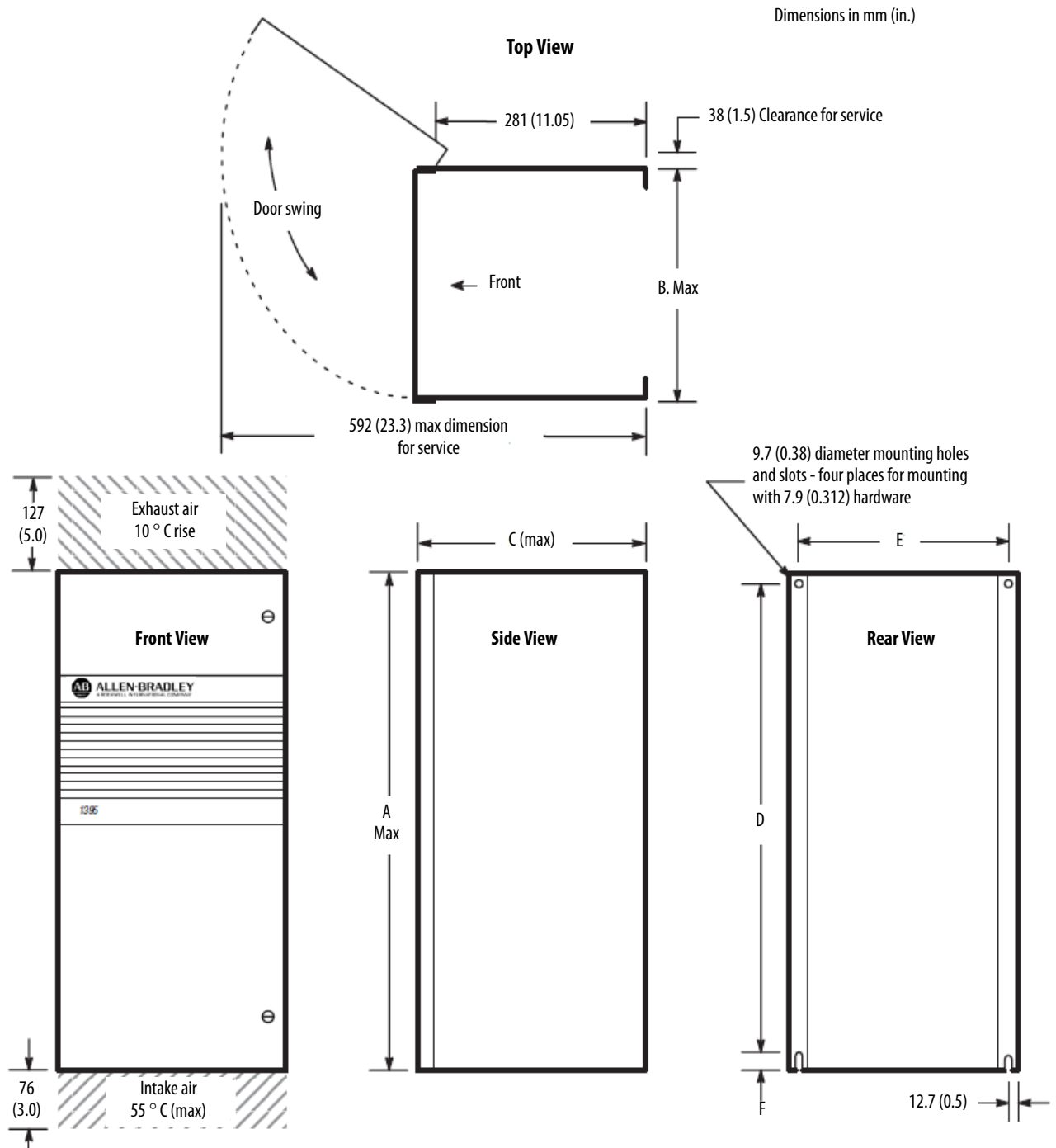
Bulletin 1395 Drive Approximate Dimensions

Figure 1 - 1395 Series B, 1...30 Hp, at 230VAC and 2...60 Hp at 460VAC



230V	460V	A	B	C	D	E	F
		mm (in.)	mm (in.)	mm (in.)	mm (in.)	mm (in.)	mm (in.)
1...30 Hp	2...60 Hp	302.2 (11.9)	279.4 (11.0)	571.5 (22.5)	596.0 (23.5)	273.0 (10.75)	609.6 (24.0)

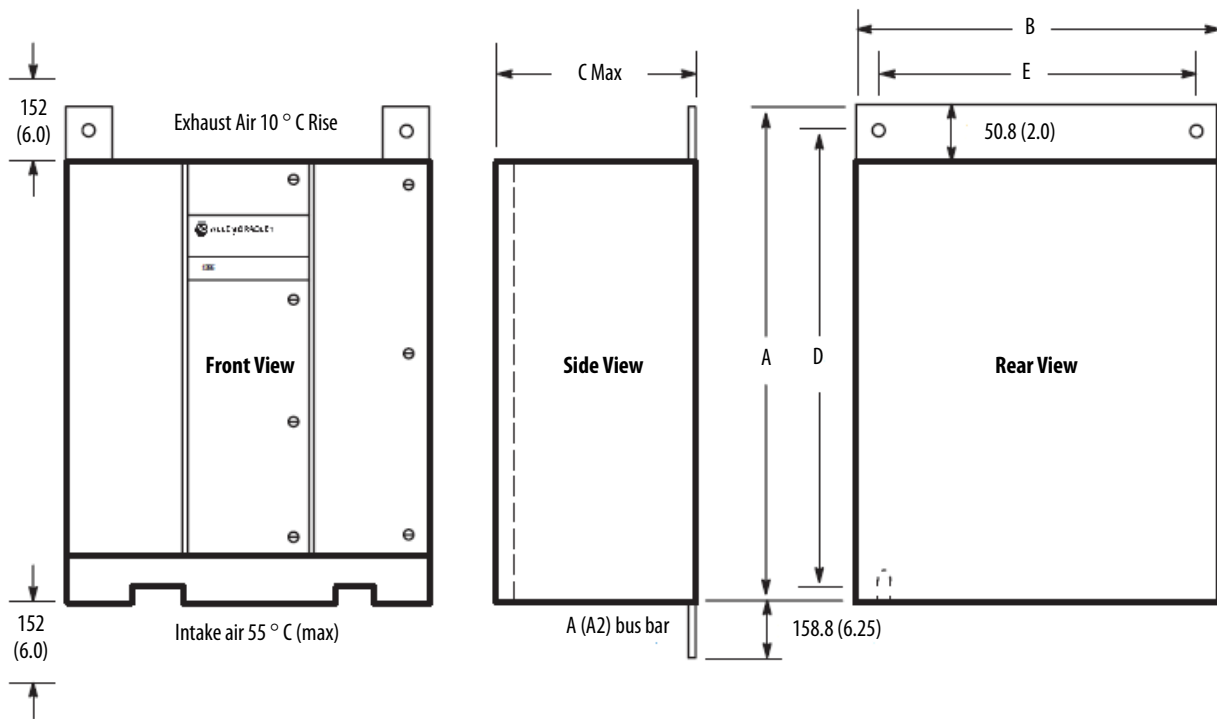
Figure 2 - 1395 Series A, 40...100 Hp at 230VAC and 75...200 Hp at 460VAC



230V	460V	A	B	C	D	E	F
		mm (in.)	mm (in.)	mm (in.)	mm (in.)	mm (in.)	mm (in.)
40...50 Hp	75...100 Hp	737.0 (29.0)	311.0 (12.3)	307.0 (12.1)	699.0 (27.5)	279.0 (11.0)	25.0 (1.0)
60...100 Hp	125...200 Hp	864.0 (34.0)	394.0 (15.5)	323.0 (12.7)	838.0 (33.0)	362.0 (14.3)	13.0 (0.5)

Figure 3 - 1395 MKVA Series B, 125...300 Hp at 230VAC and 250...600 Hp at 460VAC

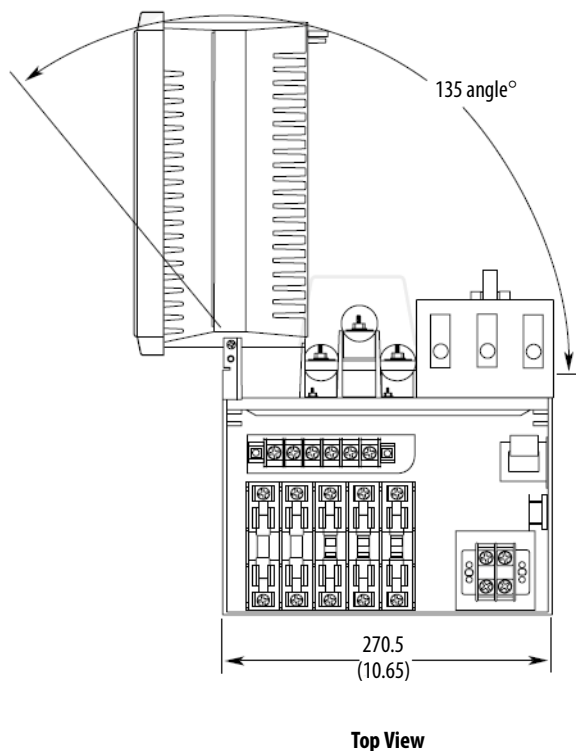
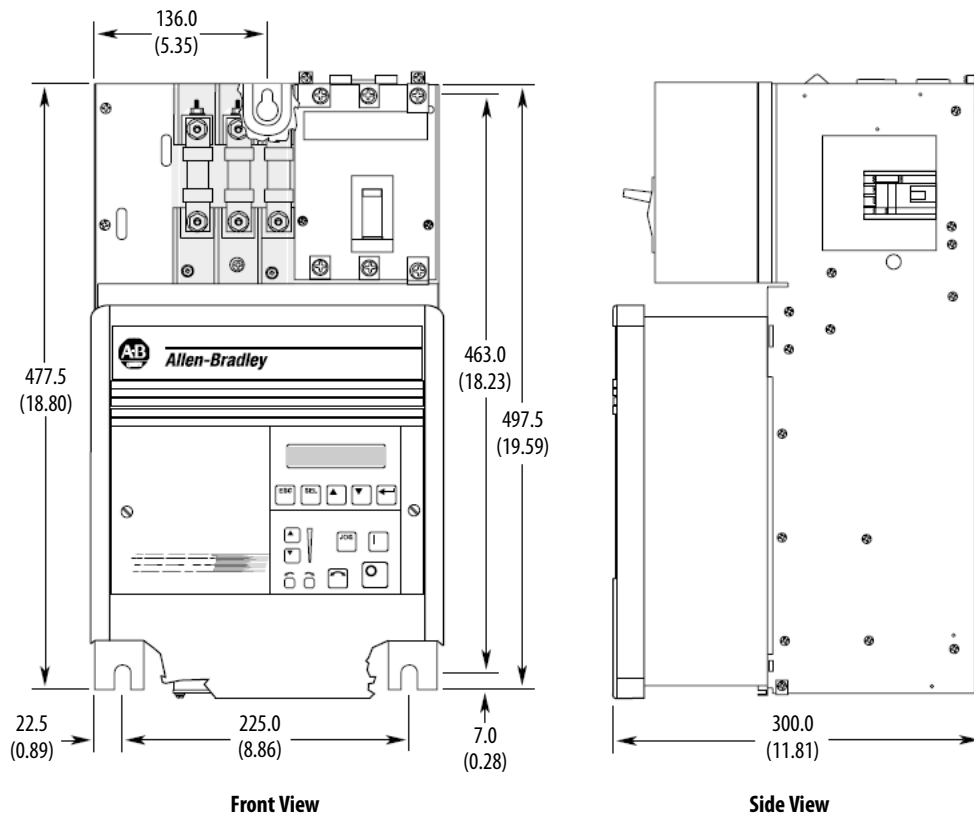
Dimensions in mm (in.)



230V	460V	A	B	C	D	E
		mm (in.)	mm (in.)	mm (in.)	mm (in.)	mm (in.)
125...300 Hp	250...600 Hp	1168.0 (46.0)	813.0 (32.0)	470.0 (18.5)	1118.0 (44.0)	711.0 (28.0)

Bulletin 1397 Drive Approximate Dimensions

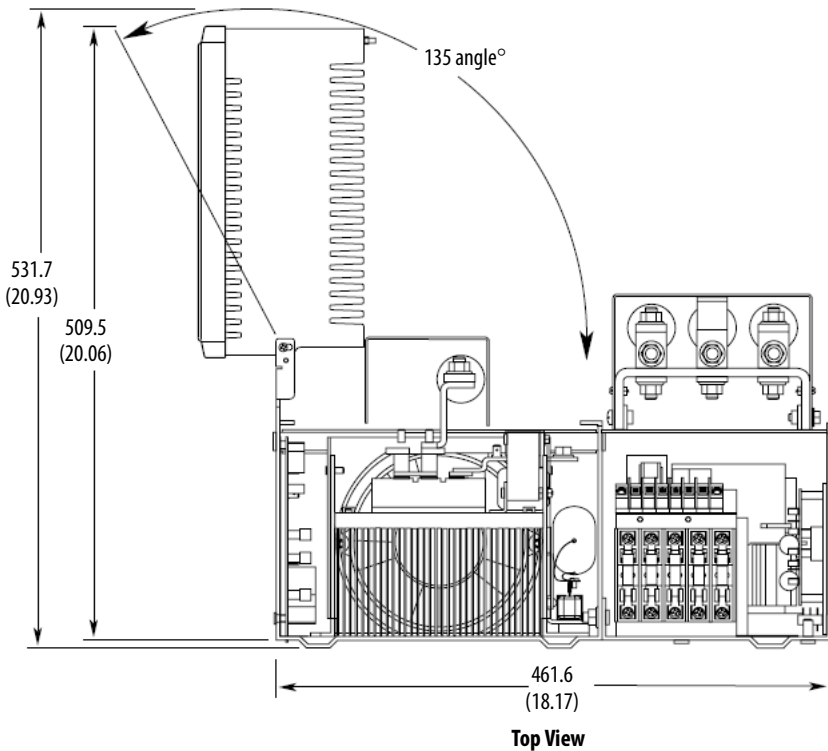
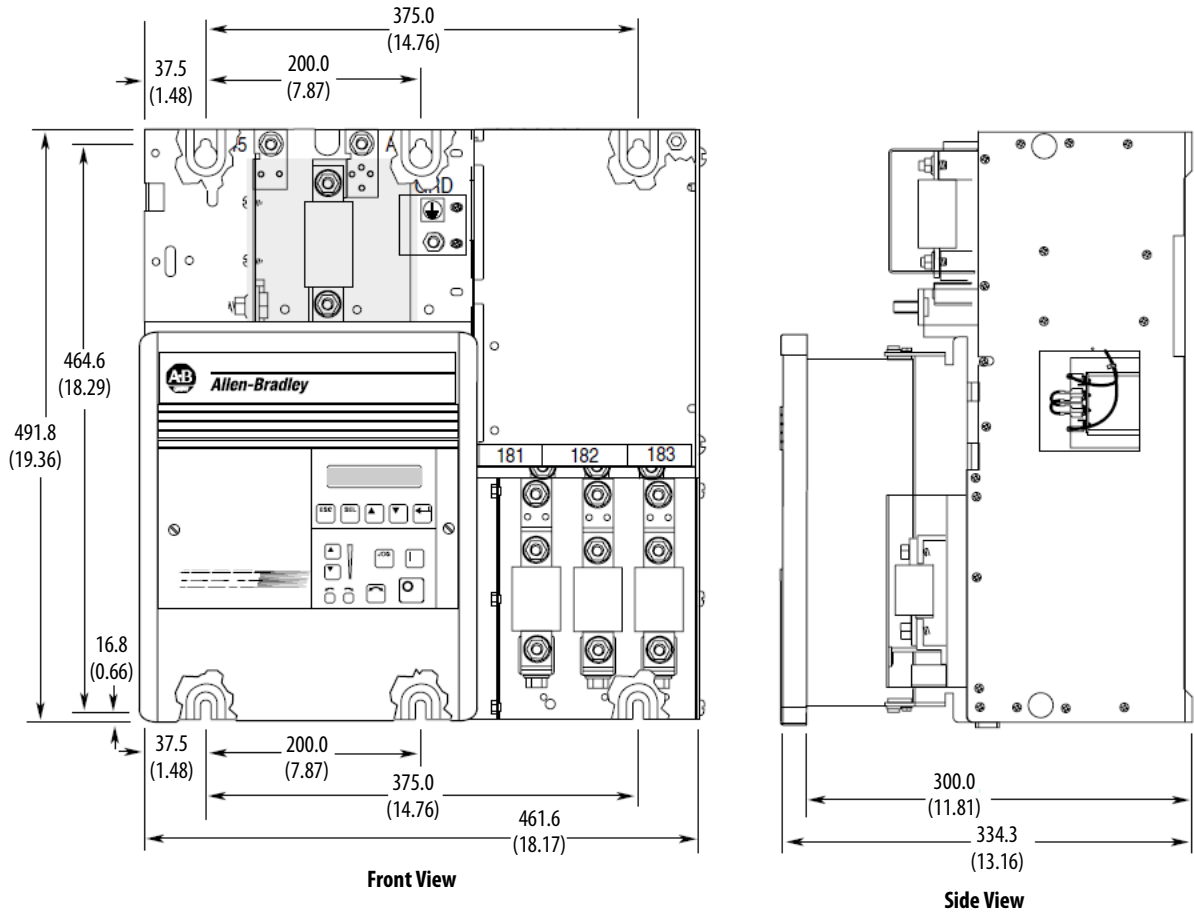
Figure 4 - 1397 - 1.5...30 Hp at 230VAC, 7...110 A at 380/415VAC, 3...60 Hp at 460VAC



Rec. hardware
3xM6 or 1/4 in.

All dimensions are in mm (in.)
Approximate shipping weight 30.8 kg (68 lb)

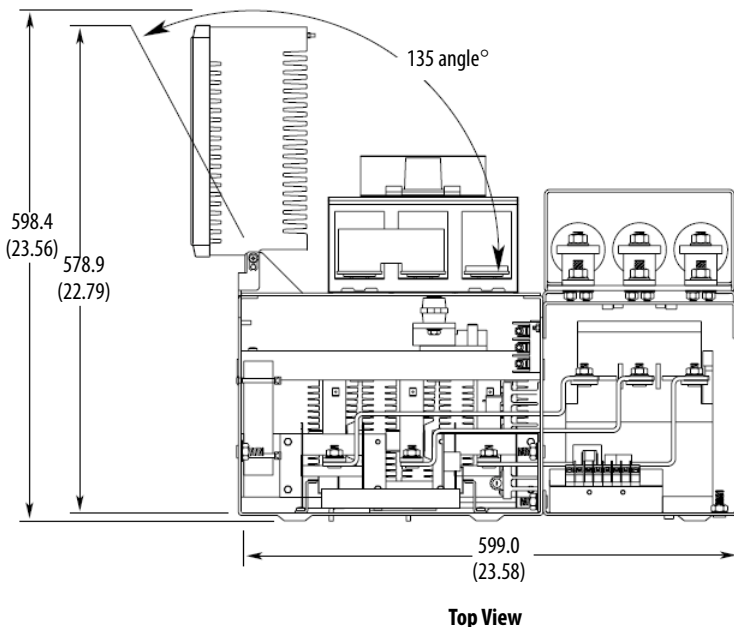
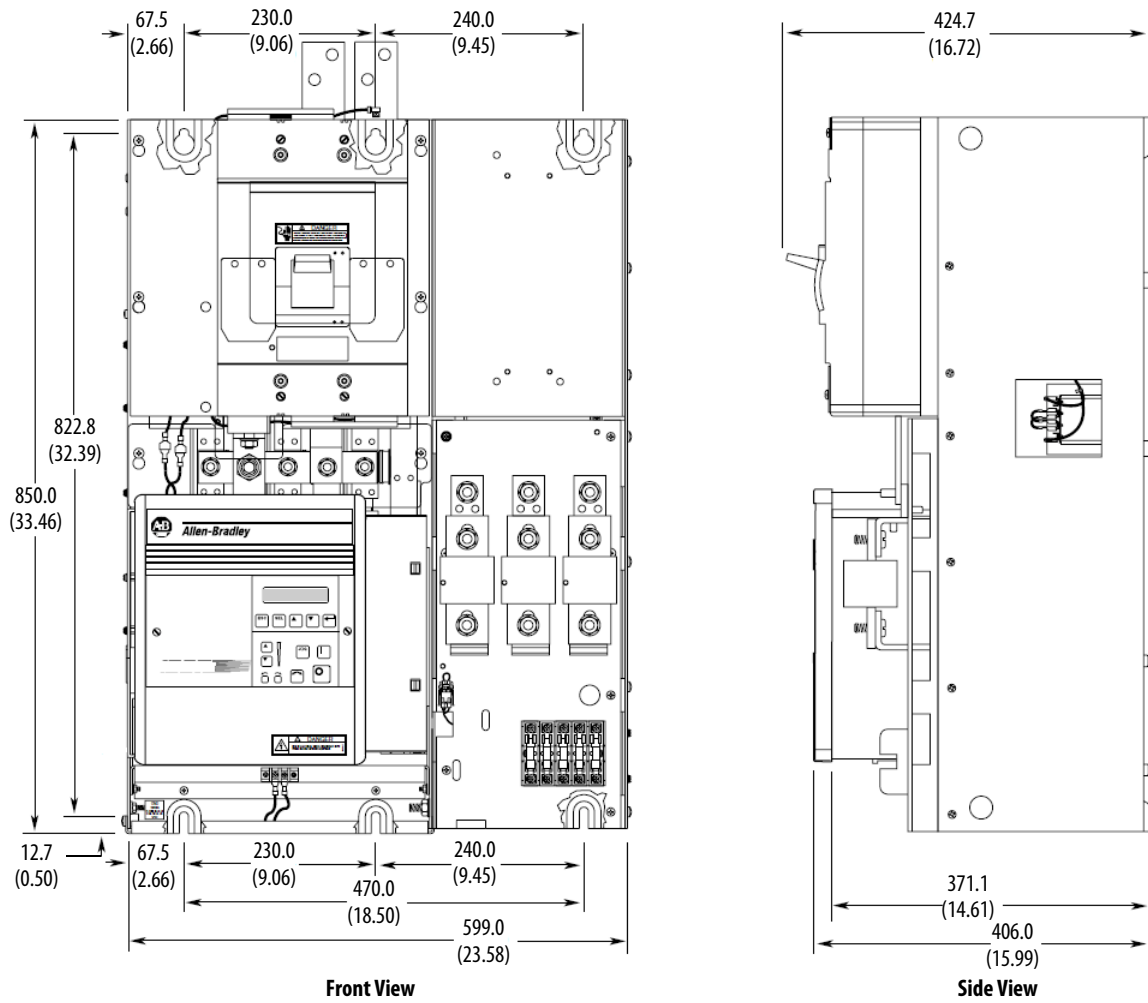
Figure 5 - 1397 - 40...75 Hp at 230VAC, 265 A at 380/415VAC, 75...150 Hp at 460 VAC



Rec. hardware
3xM6 or 1/4 in.

All dimensions are in mm (in.)
Approximate shipping weight 30.8 kg (68 lb)

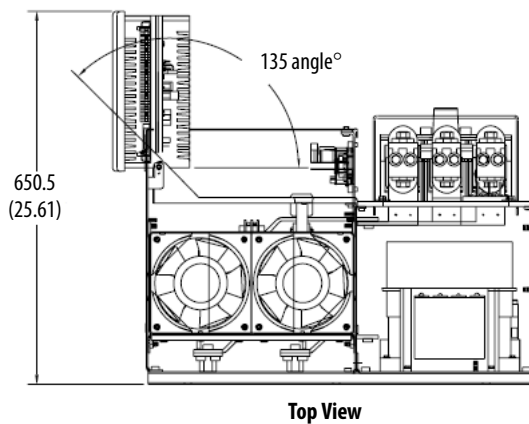
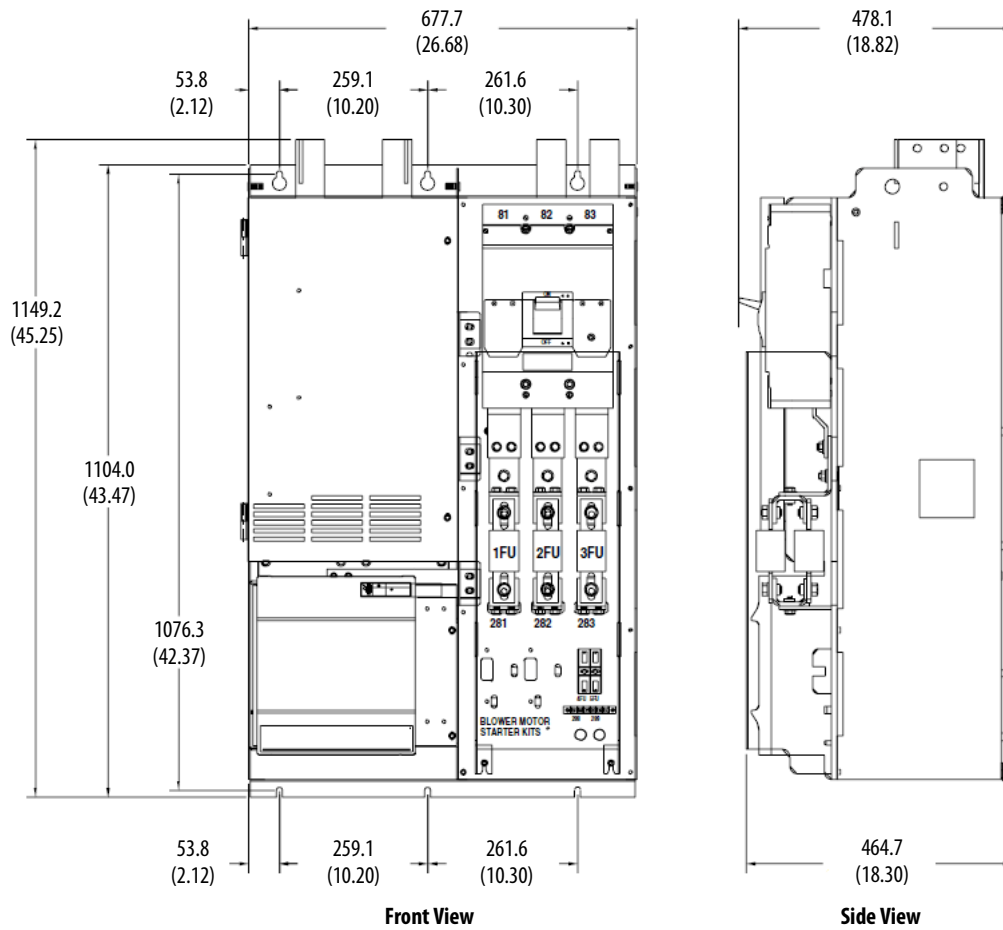
Figure 6 - 1397 - 150 Hp at 230VAC, 200...300 Hp at 460VAC



Rec. hardware
3xM6 or 1/4 in.

All dimensions are in mm (in.)
Approximate shipping weight 30.8 kg (68 lb)

Figure 7 - 1397 - 400...600 Hp at 460VAC



All dimensions are in mm (in.)

FlexPak 3000 Drive Approximate Dimensions

Figure 8 - FlexPak 3000 - 1.5...30 Hp at 230VAC, 3...60 Hp at 460VAC / 7...110 A Rated Output

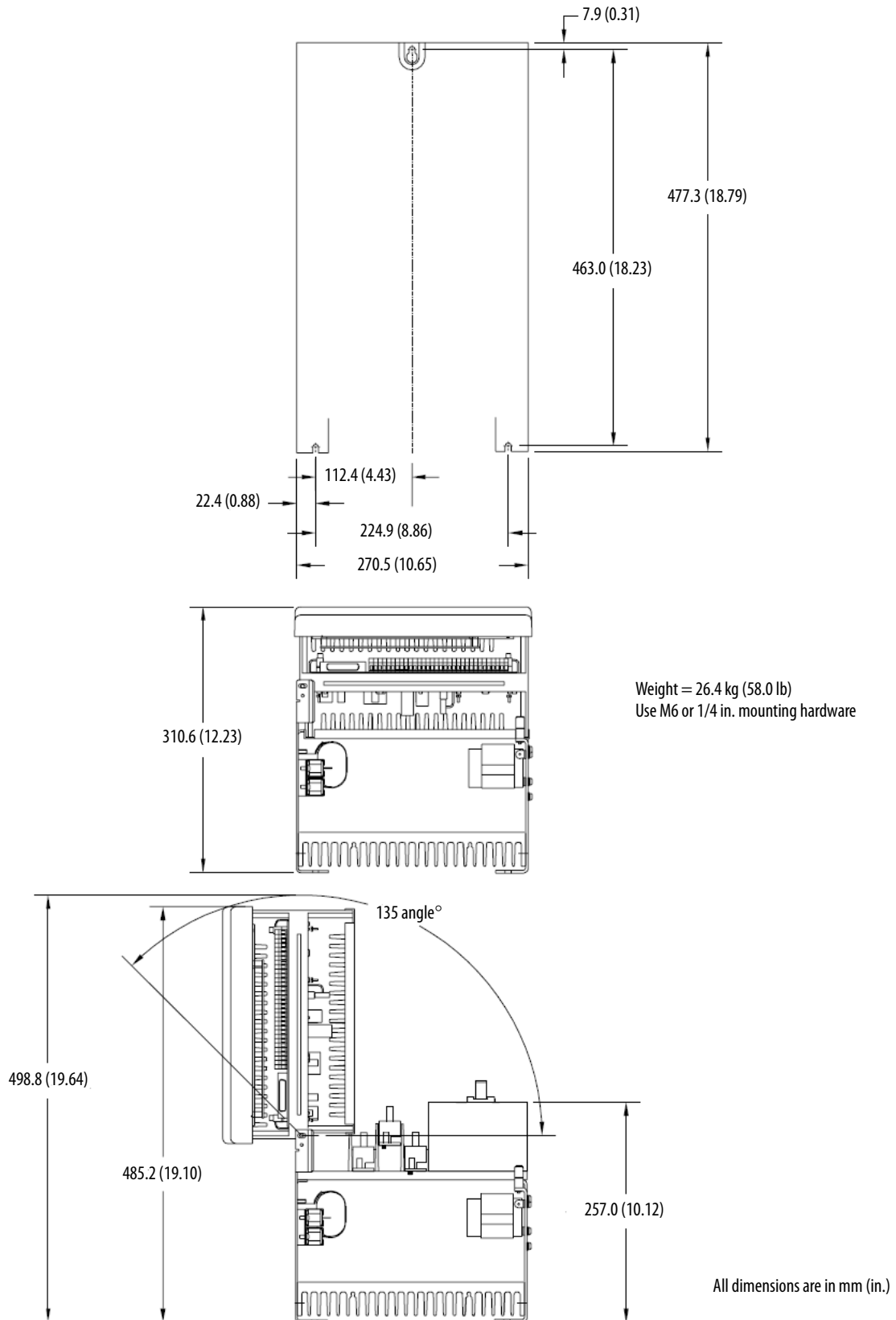


Figure 9 - FlexPak 3000 - 40...75 Hp at 230VAC, 75...150 Hp at 460VAC / 265 A Rated Output

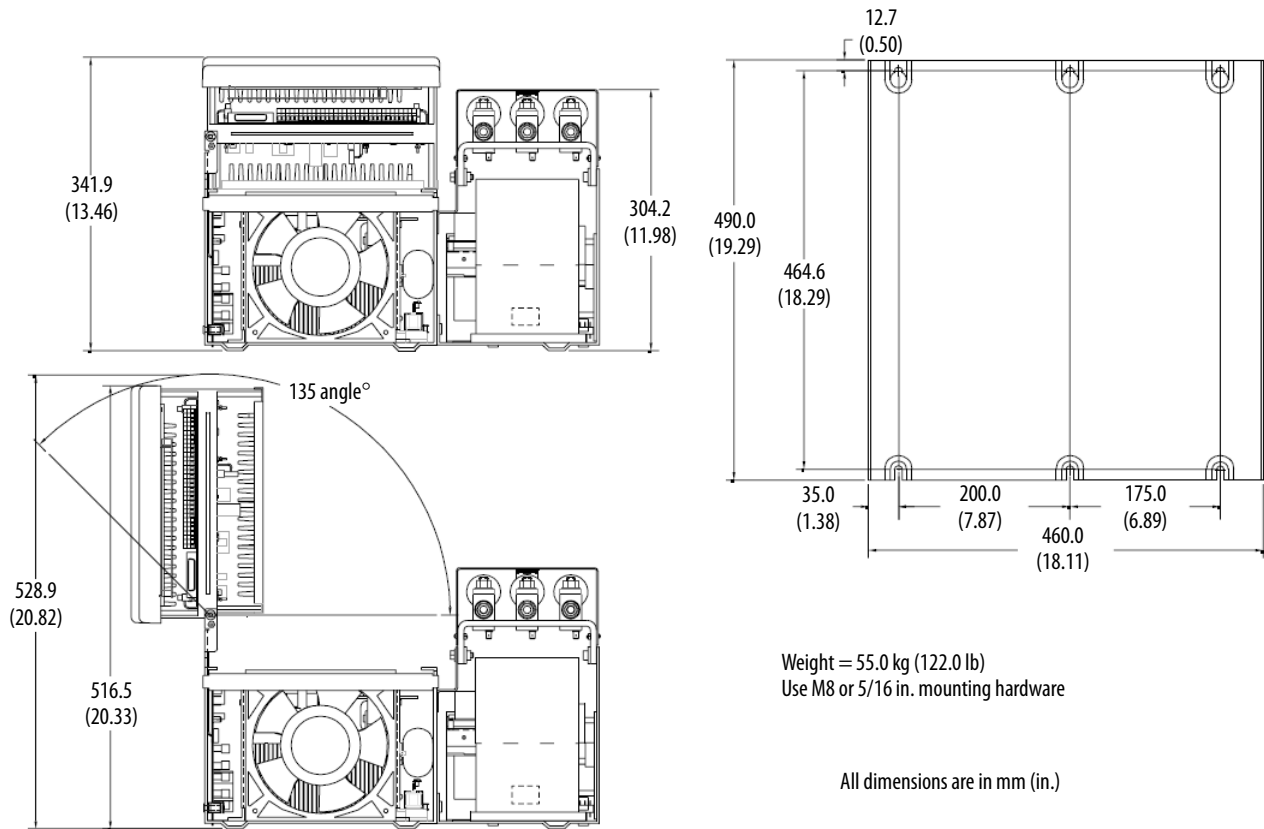
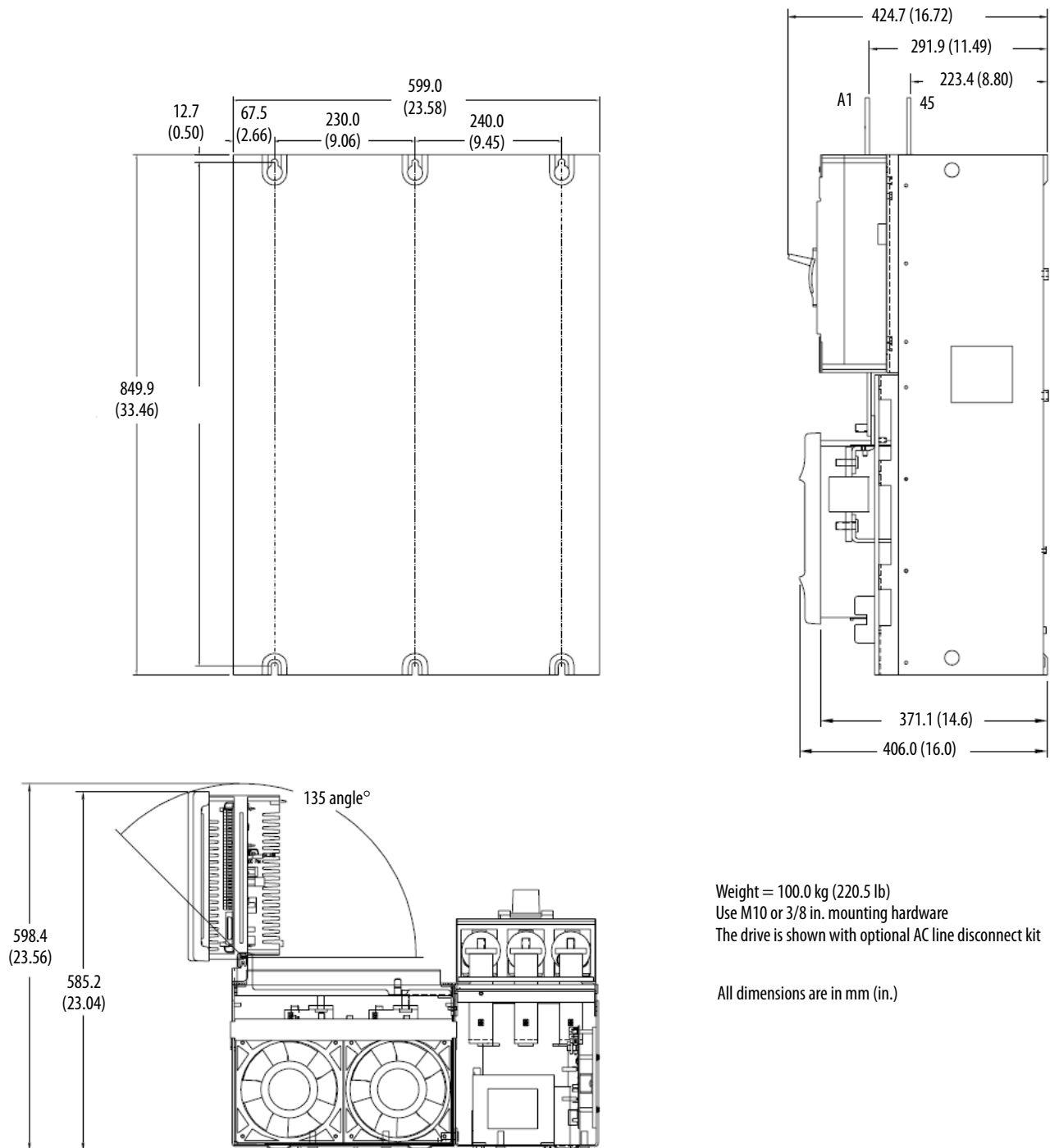


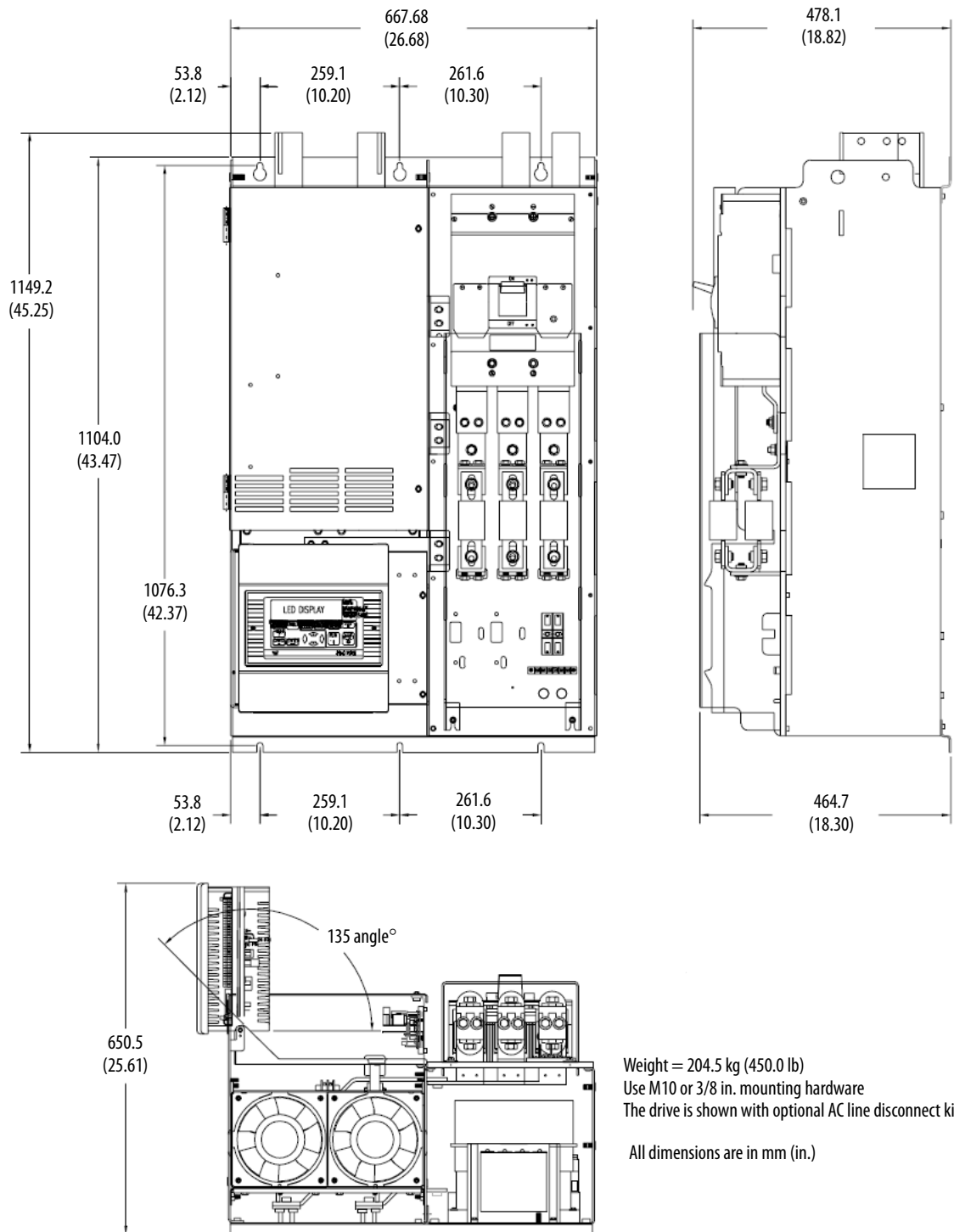
Figure 10 - FlexPak 3000 - 100...150 Hp at 230VAC, 200...300 Hp at 460VAC



Weight = 100.0 kg (220.5 lb)
 Use M10 or 3/8 in. mounting hardware
 The drive is shown with optional AC line disconnect kit

All dimensions are in mm (in.)

Figure 11 - FlexPak 3000 - 400...600 Hp at 460VAC



Weight = 204.5 kg (450.0 lb)
 Use M10 or 3/8 in. mounting hardware
 The drive is shown with optional AC line disconnect kit
 All dimensions are in mm (in.)

Figure 12 - FlexPak 3000 Integrated Drive - 1.5...30 Hp at 230VAC, 3...60 Hp at 460VAC

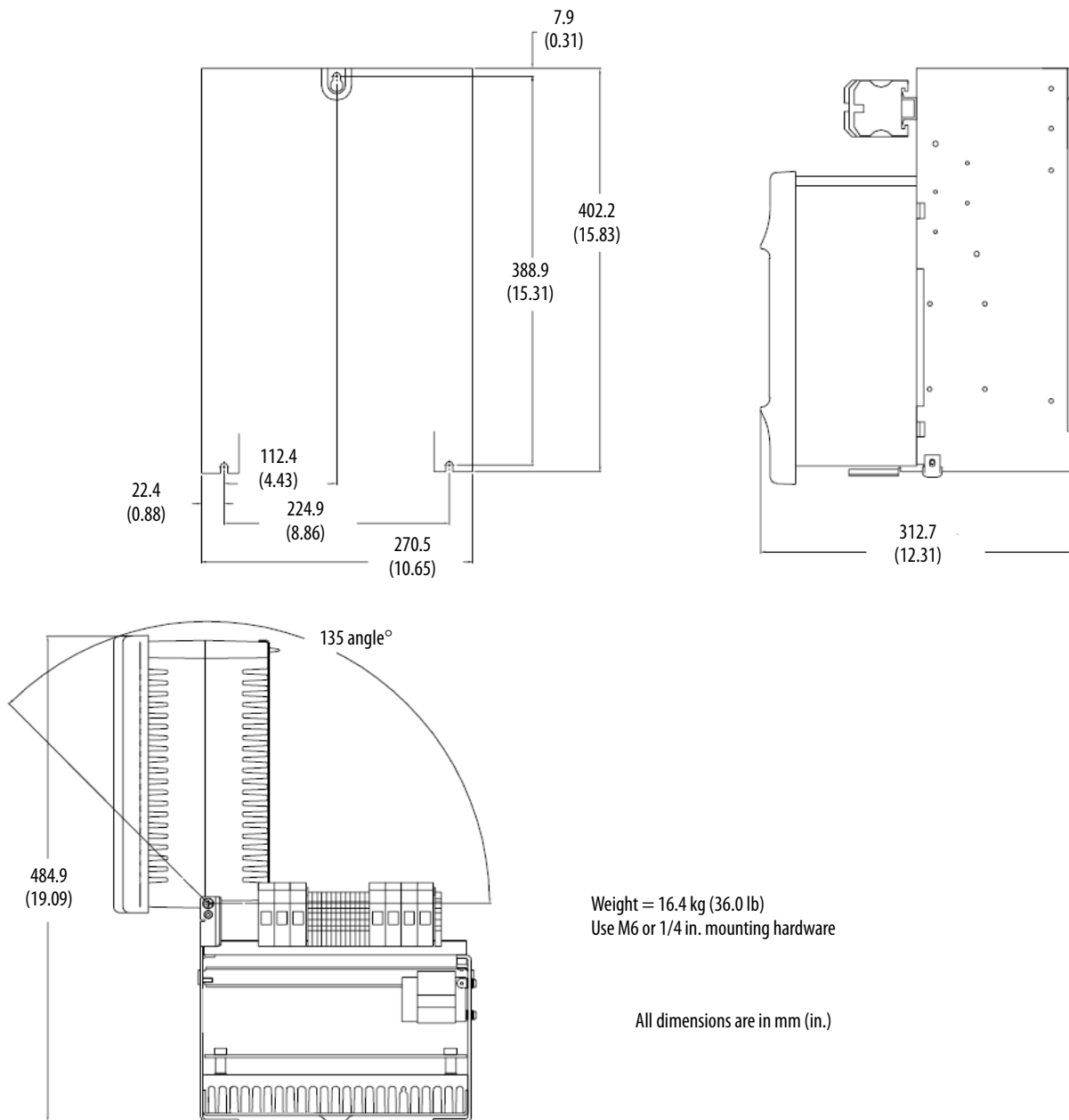
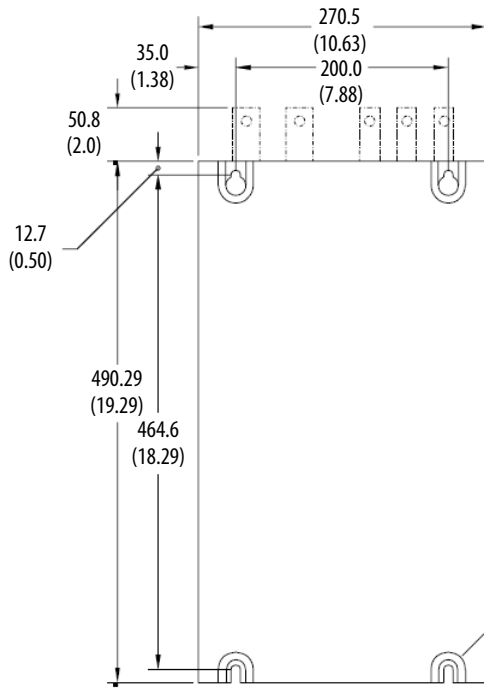
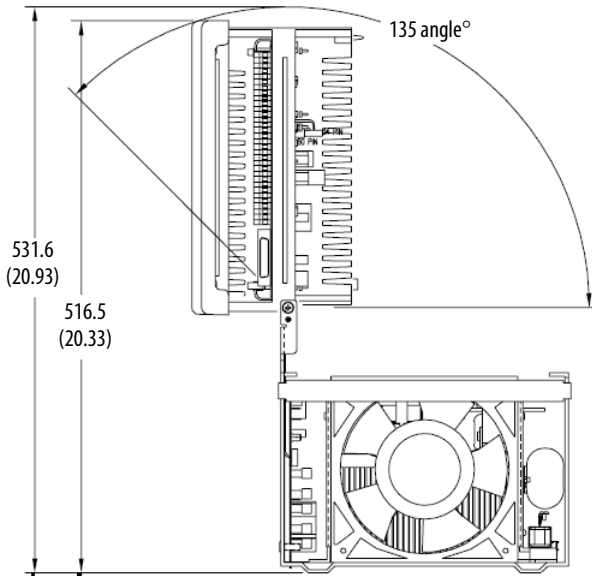
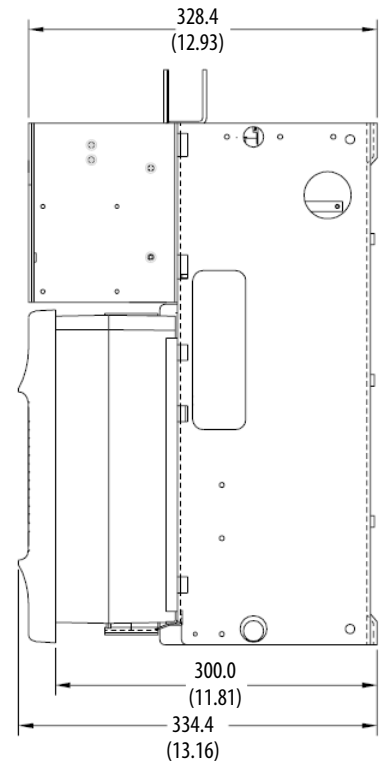


Figure 13 - FlexPak 3000 Integrated Drive - 40...75 Hp at 230VAC, 75...150 Hp at 460VAC



Mounting hole for M8x1.25 hardware or equivalent - four places.

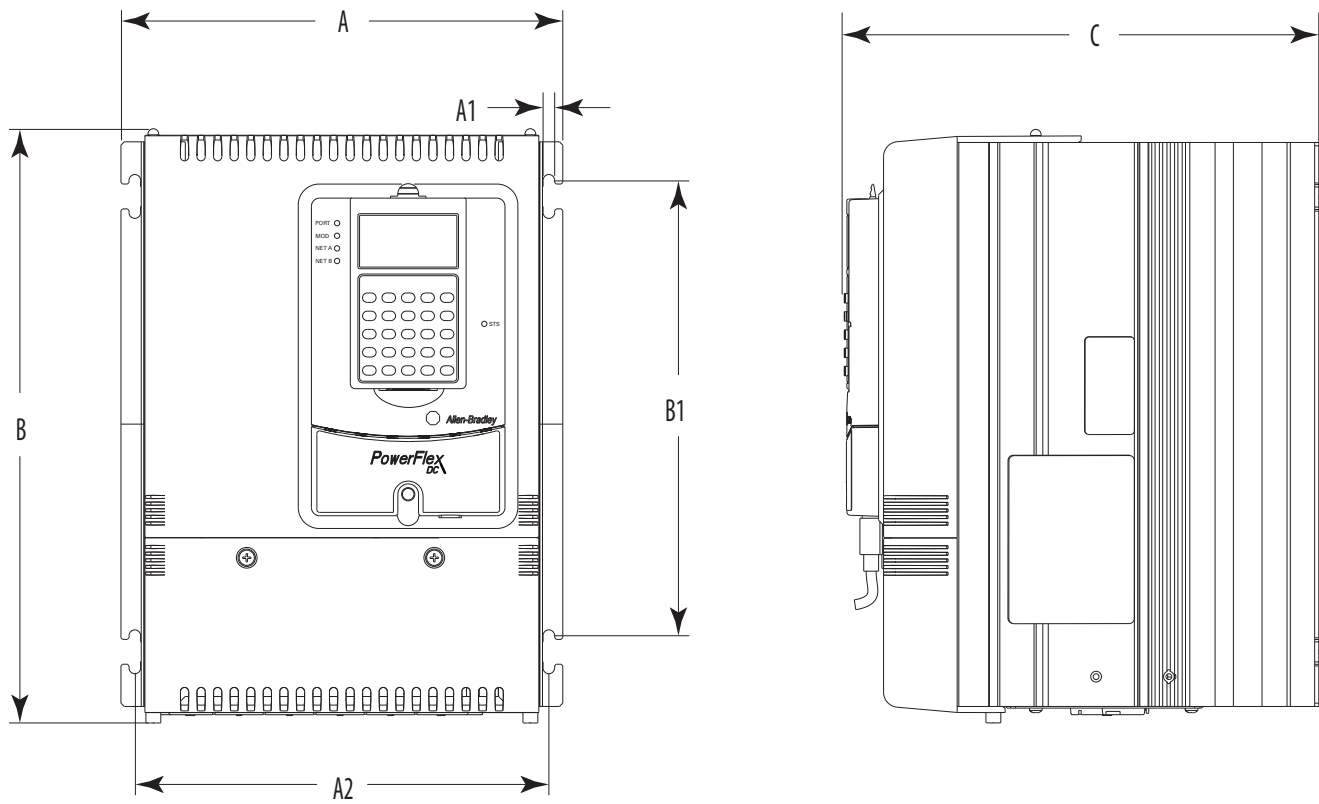


Weight = 36.3 kg (80.0 lb)
Use M8 or 5/16 in. mounting hardware

All dimensions are in mm (in.)

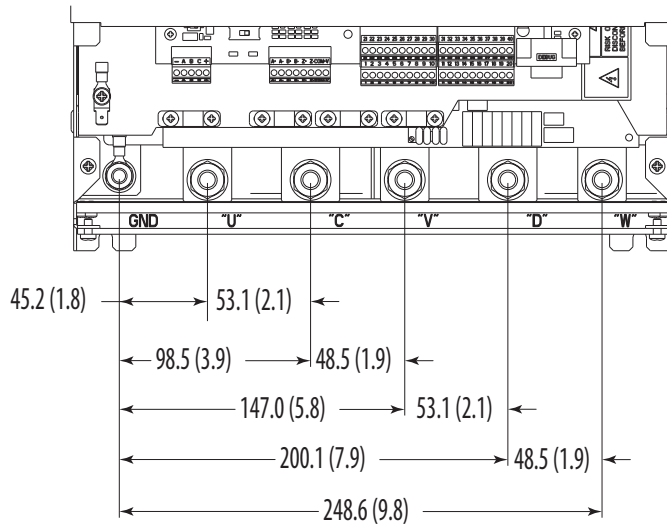
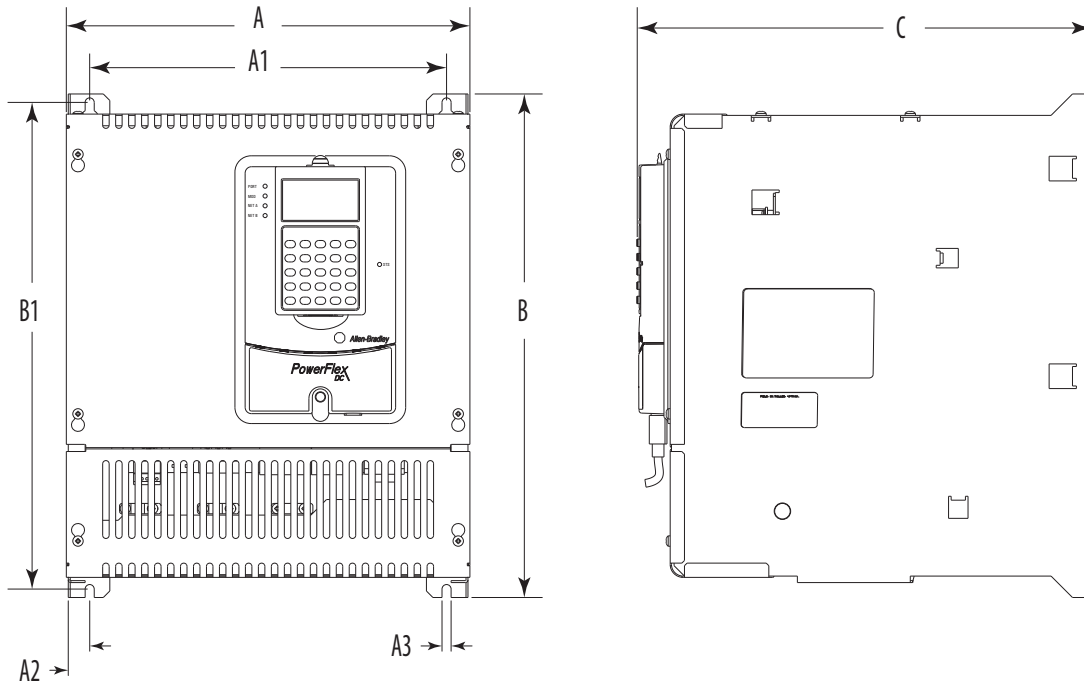
PowerFlex DC Drive Approximate Dimensions

Figure 14 - PowerFlex DC Frame A, 1.5...30 Hp at 230VAC, 2...75 Hp at 460VAC



A	B	C	A1	A2	B1
mm (in.)	mm (in.)	mm (in.)	mm (in.)	mm (in.)	mm (in.)
267 (10.5)	359 (14.0)	287 (11.3)	7 (0.3)	250 (9.8)	275 (10.8)

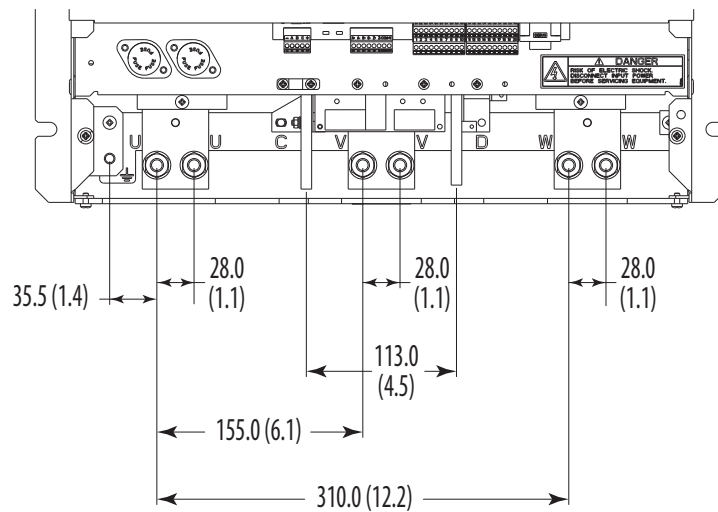
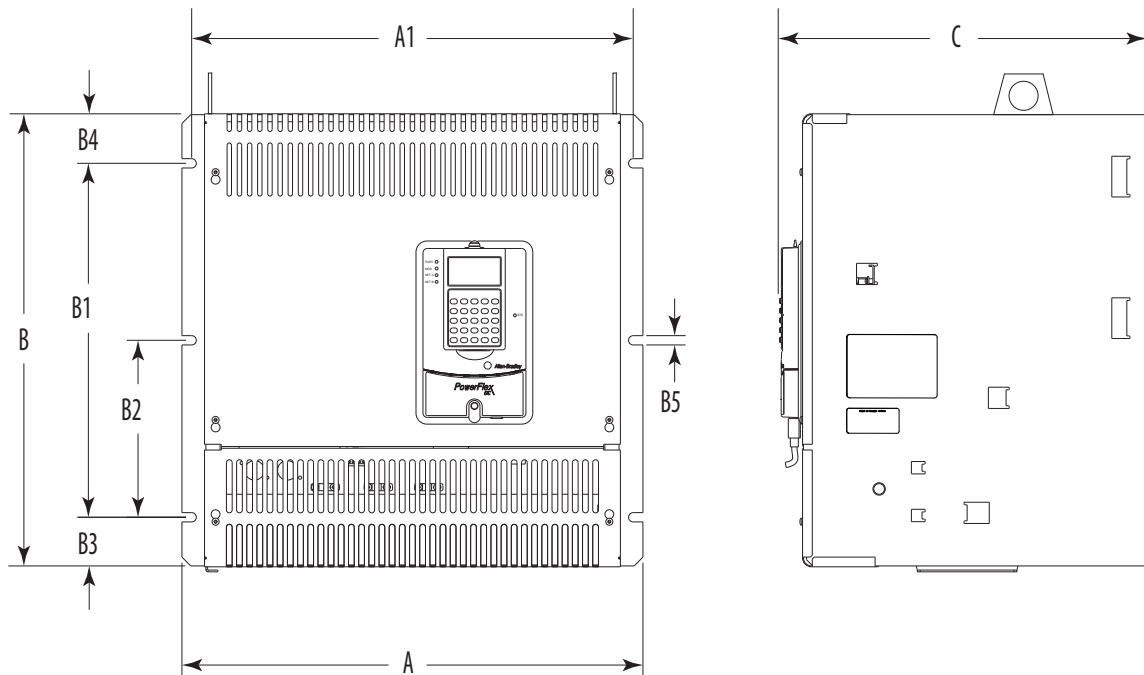
Figure 15 - PowerFlex DC Frame B, 40...125 Hp at 230VAC, 100...250 Hp at 460VAC, 50...300 Hp at 575VAC



Terminal Details Dimensions in mm (in.)

A	A1	A2	A3	B	B1	C
mm (in.)	mm (in.)	mm (in.)	mm (in.)	mm (in.)	mm (in.)	mm (in.)
311 (12.2)	275 (10.8)	16.5 (0.65)	7 (0.3)	388 (15.3)	375 (14.8)	350 (13.8)

Figure 16 - PowerFlex DC Frame C, 150...200 Hp at 230VAC, 300...400 Hp at 460VAC, 400...500 Hp at 575VAC, 400...500 Hp at 690VAC



Terminal Details Dimensions in mm (in.)

A	A1	B	B1	B2	B3	B4	B5	C
mm (in.)	mm (in.)	mm (in.)	mm (in.)	mm (in.)	mm (in.)	mm (in.)	mm (in.)	mm (in.)
521 (20.5)	499 (19.7)	511 (20.1)	400 (15.7)	200 (7.9)	55 (2.2)	56 (2.2)	10.5 (0.4)	416 (16.4)

Figure 17 - PowerFlex DC Frame D, 250...300 Hp at 230VAC, 500...900 Hp at 460VAC, 600...1250 Hp at 575VAC, 600...1400 Hp at 690VAC

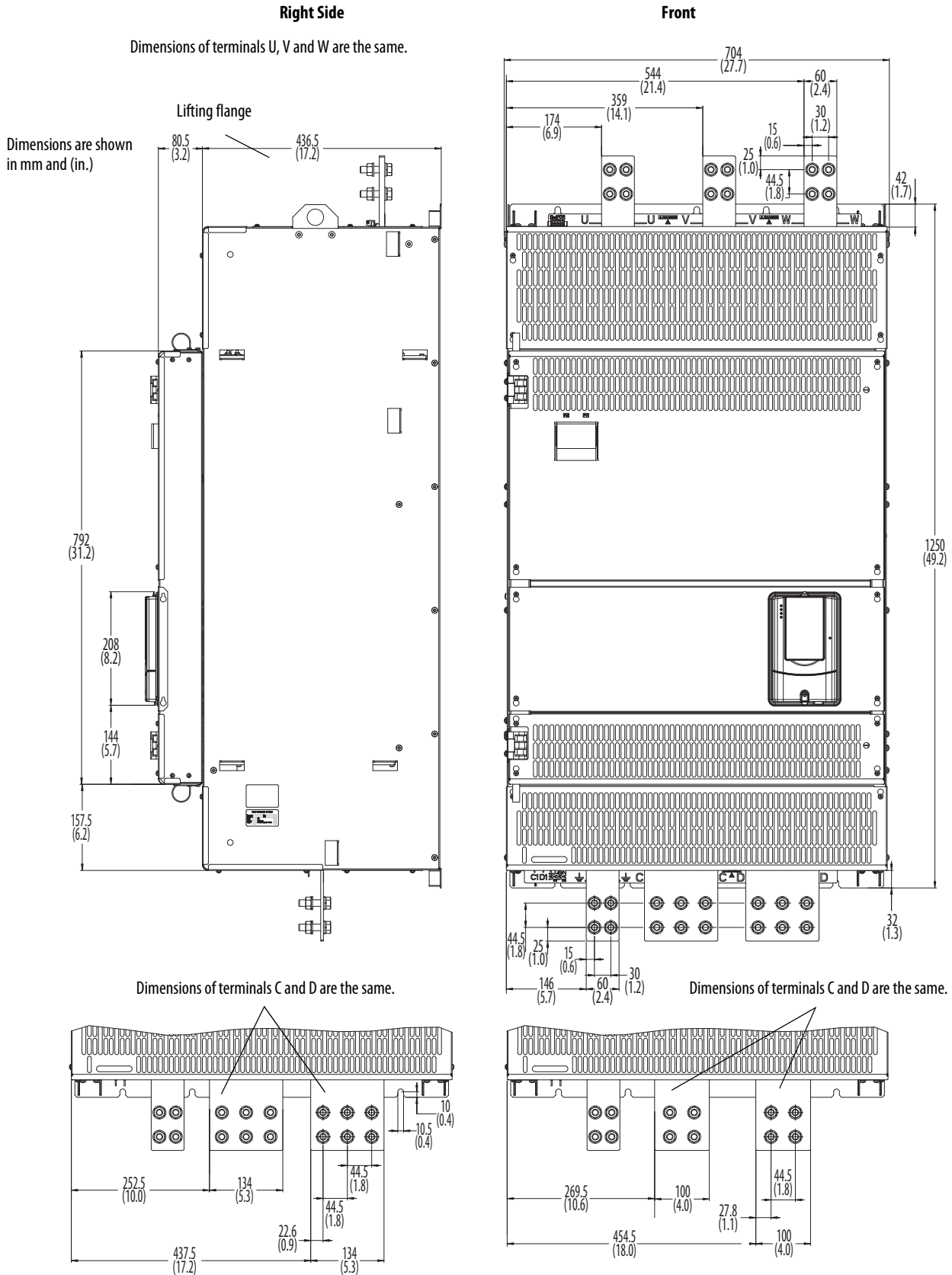
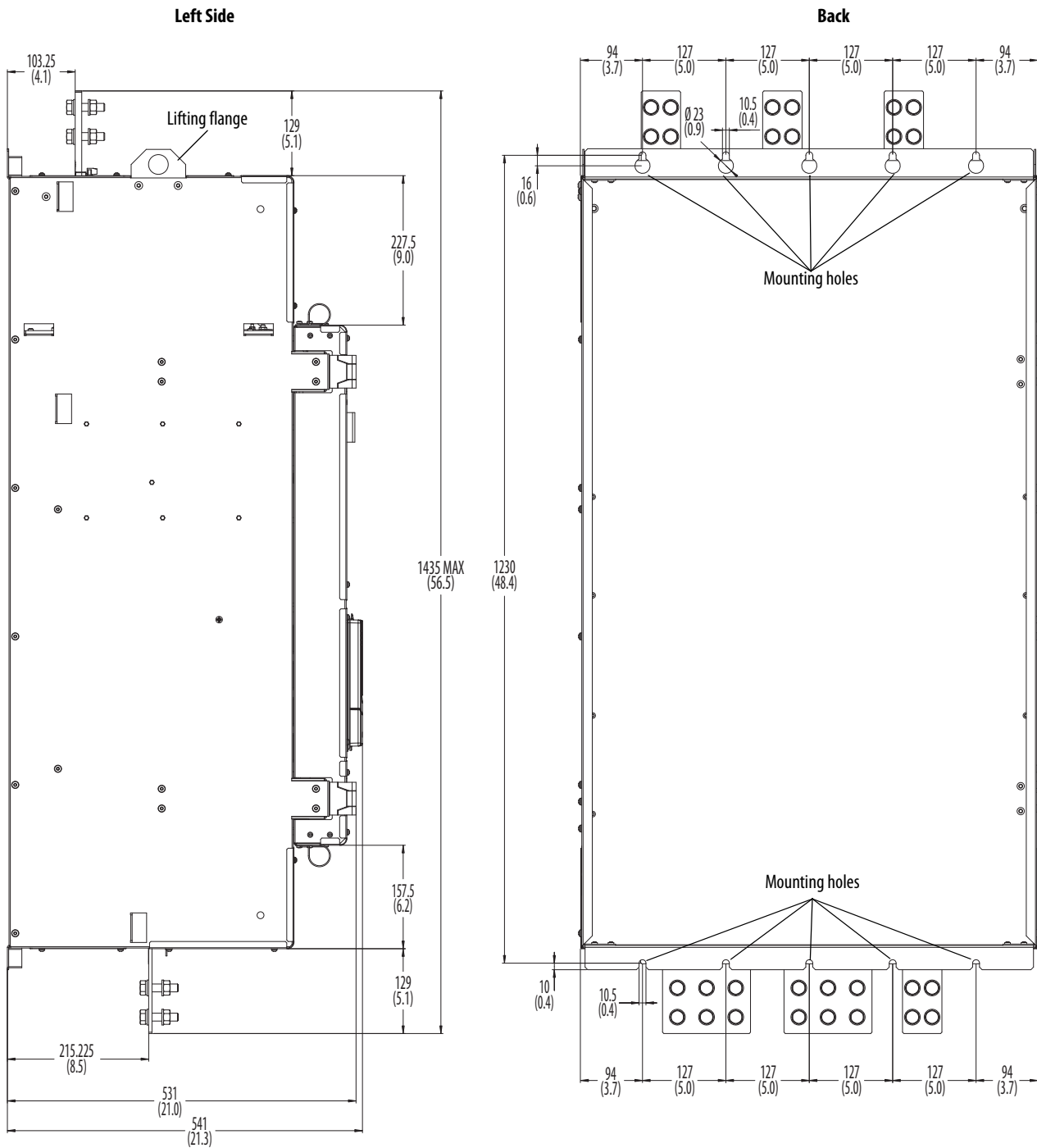


Figure 18 - PowerFlex DC Frame D

Dimensions are shown in mm and (in.)



Power Comparisons

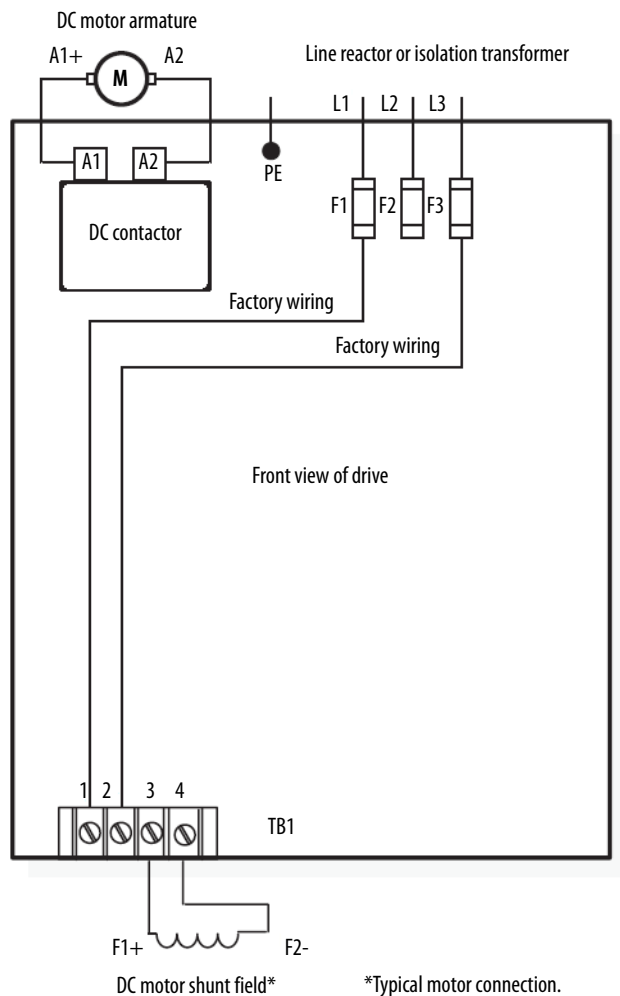
1395 Power Connections - Standard Field Voltage



ATTENTION: The motor field supply is phase sensitive. To guard against possible drive/motor damage, assure that the connections are properly made according to [Figure 19](#), [Figure 20 on page 55](#), [Figure 21 on page 55](#), and [Figure 22 on page 56](#).

IMPORTANT If the AC input power system does not have a neutral or one phase referenced ground, an isolation transformer with the neutral of the secondary grounded is highly recommended. If the line-to-line voltages on any phase can exceed 125% of the nominal line-to-line voltage, an isolation transformer with the neutral of the secondary grounded, is always required.

Figure 19 - 1395 - 1...30 Hp, 230VAC / 2...60 Hp, 460VAC Series



*Typical motor connection.
Refer to motor data for specific motor connections.

Figure 20 - 1395 - 40...100 Hp, 230VAC / 75...200 Hp, 460VAC Series A

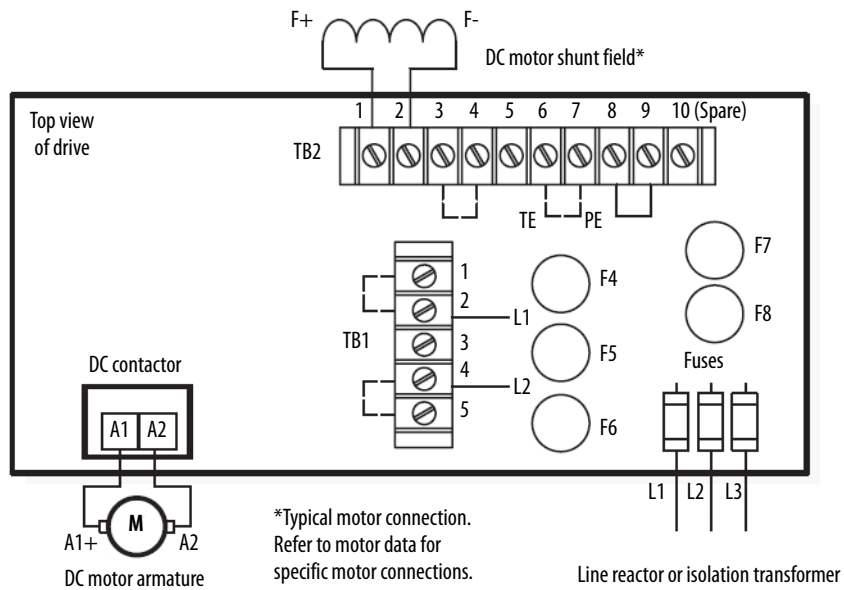
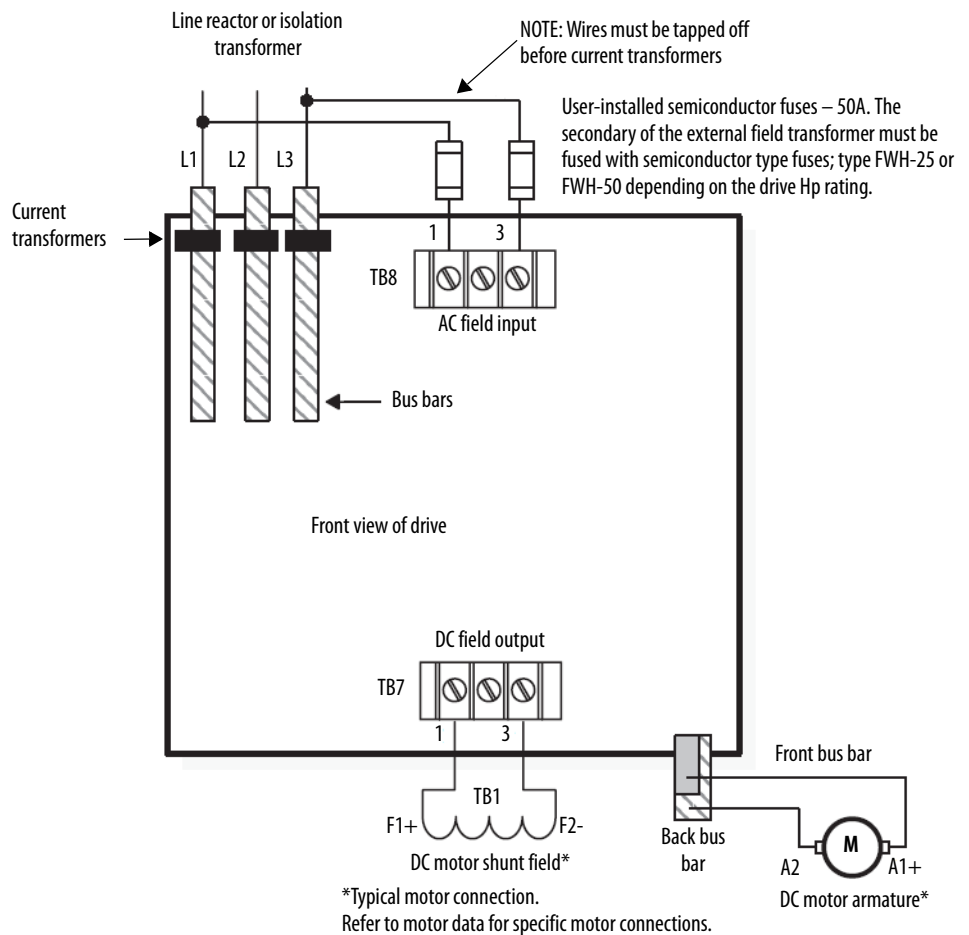
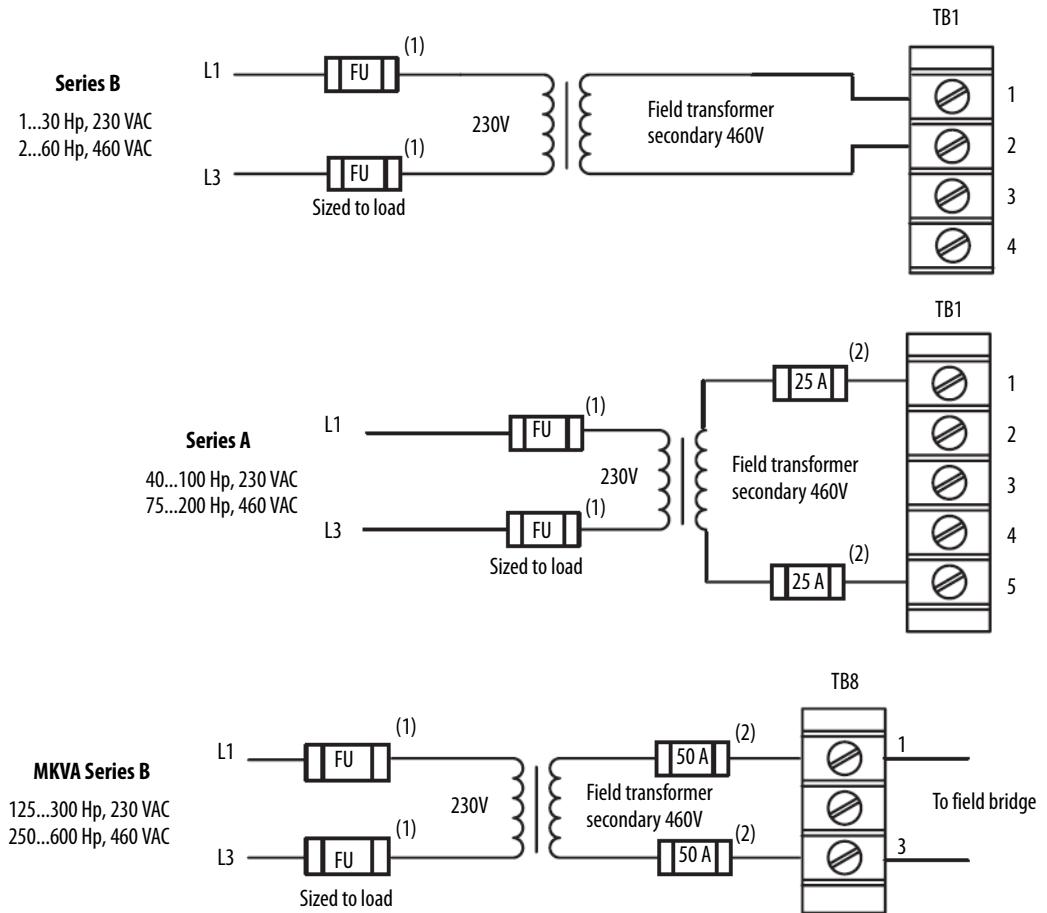


Figure 21 - 1395 - 125...300 Hp, 230VAC Transformer / 250...600 Hp, 460VAC MKVA Series B



1395 External Field Transformer Connections

Figure 22 - 1395 - All Drives



- (1) The primary of the external field transformer requires branch circuit protection, to be fused with FRN or FRS style fuses. Refer to NEC Code (and local codes) for sizing.
- (2) The secondary of the external field transformer must be fused with semiconductor type fuses; type FWH-25 or FWH-50 depending on drive Hp rating.

1397 AC Input Line Connections



ATTENTION: If the AC input power system does not have a neutral or one phase referenced ground, an isolation transformer with the neutral of the secondary grounded is highly recommended. If the line-to-line voltages on any phase can exceed 125% of the nominal line-to-line voltage, an isolation transformer with the neutral of the secondary grounded, is always required. Failure to observe these precautions could result in bodily injury or damage to equipment.

Figure 23 - 1397 - 1.5...30 Hp at 230 VAC, 3...60 Hp at 460 VAC, 7...110 A at 380/415 VAC

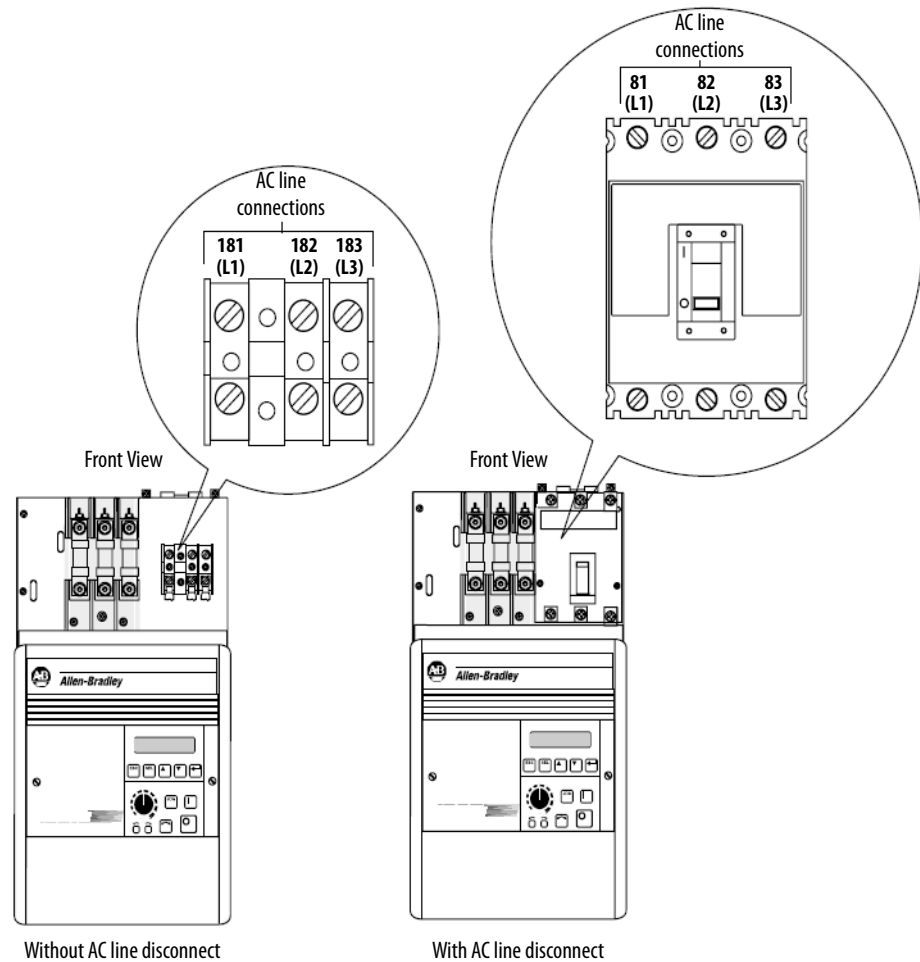


Figure 24 - 1397 - 40...75 Hp at 230 VAC, 75...150 Hp at 460 VAC, 265 A at 380/415 VAC

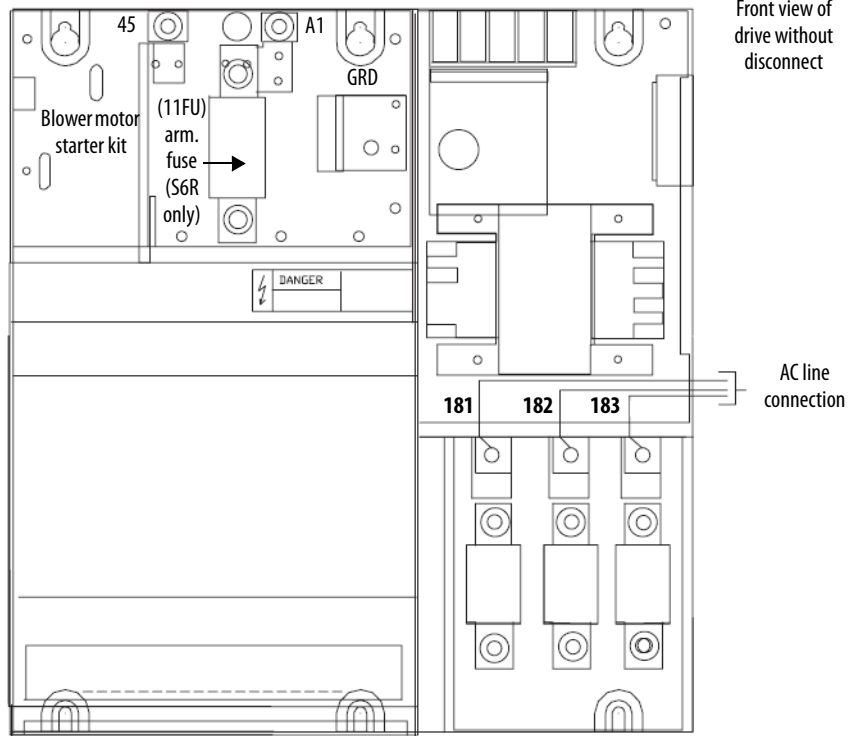


Figure 25 - 1397 - 100...150 Hp at 230 VAC, 200...300 Hp at 460 VAC

Shown without AC
line disconnect

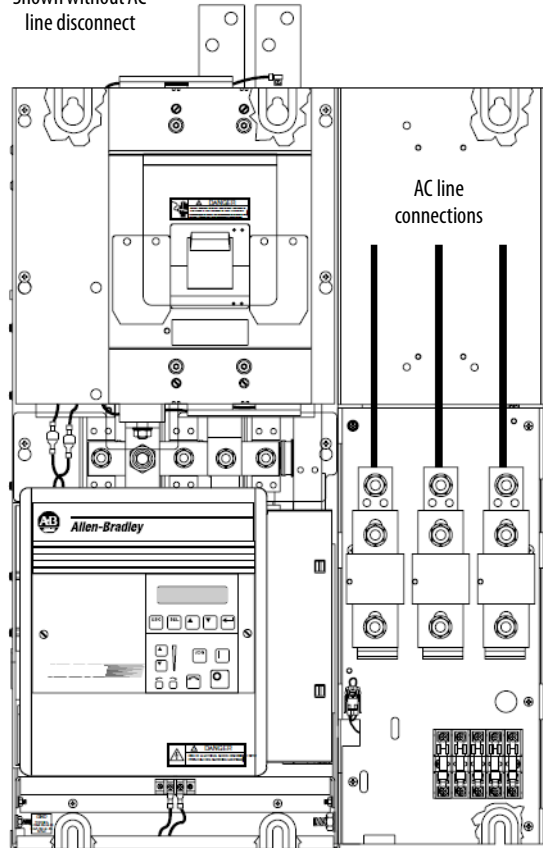
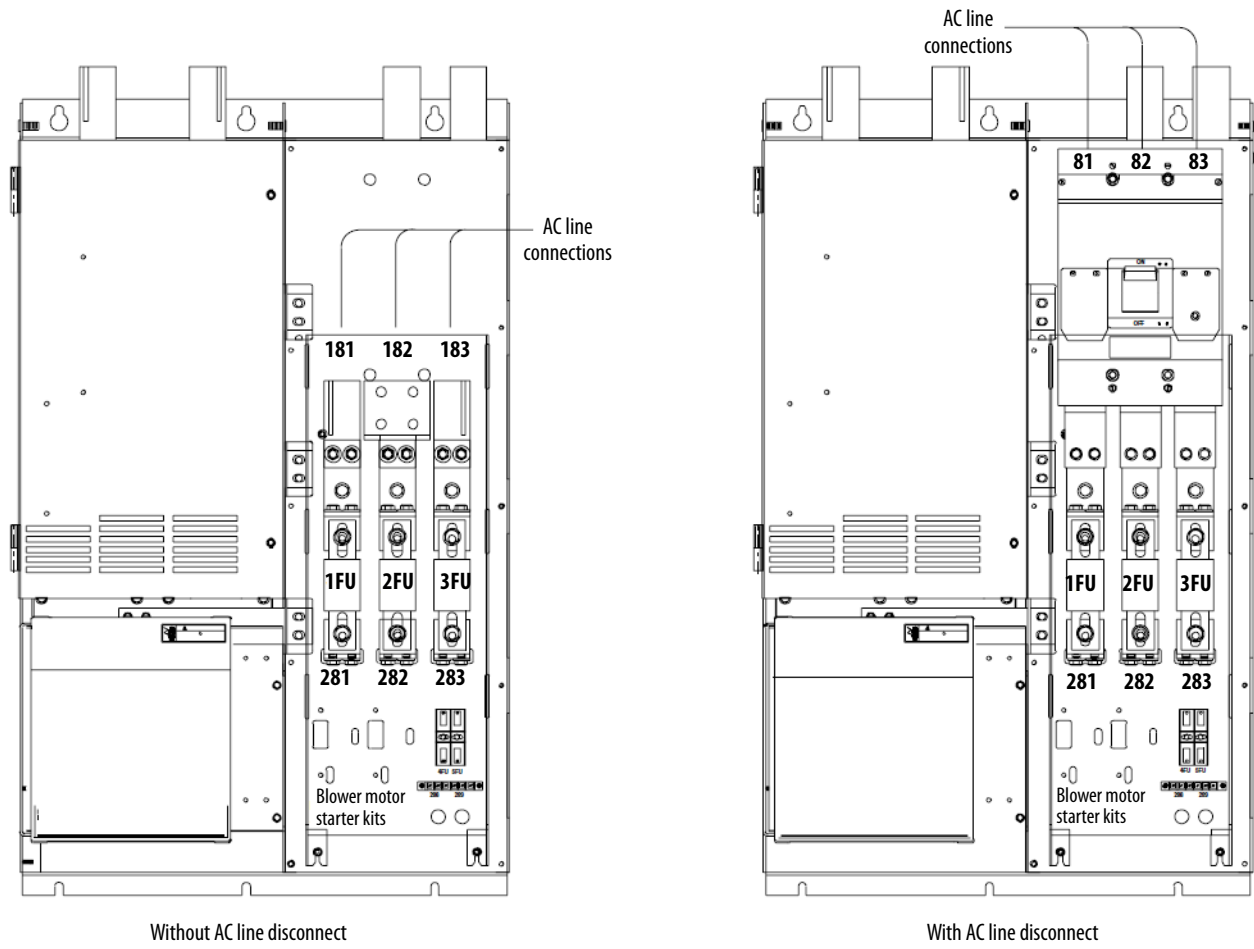


Figure 26 - 1397 - 400...600 Hp at 460 VAC



1397 Field and Motor Armature Connections

Figure 27 - 1397 - 1.5...30 Hp at 230 VAC, 3...60 Hp at 460 VAC, 7...110 A at 380/415 VAC

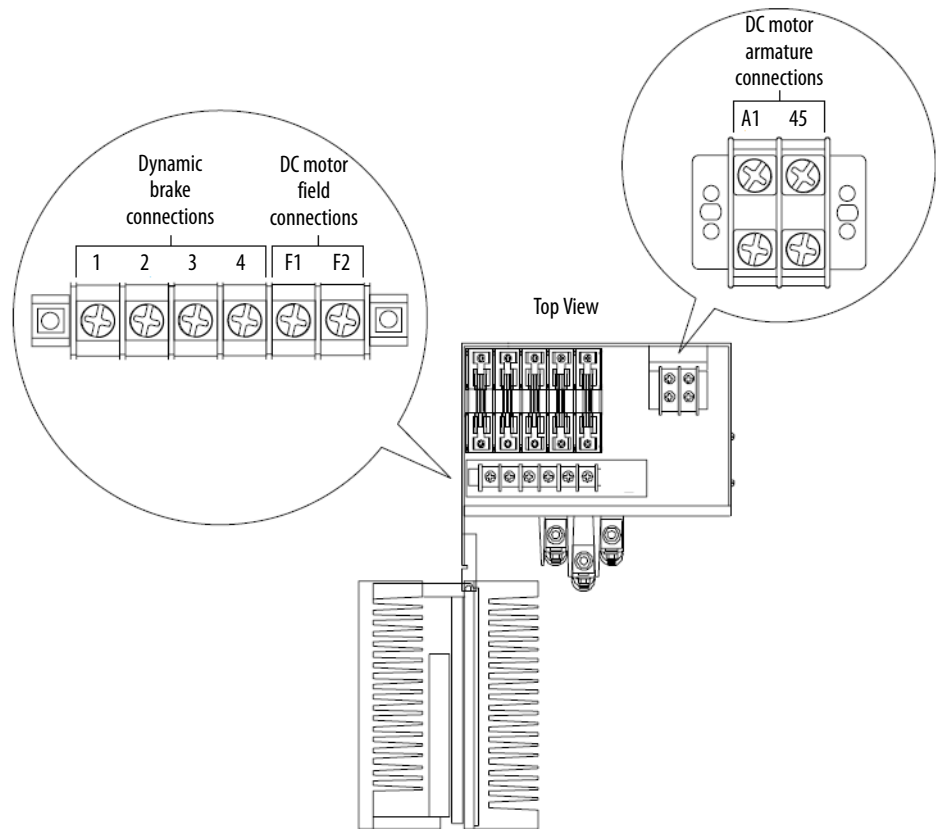


Figure 28 - 1397 - 40...75 Hp at 230 VAC, 75...150 Hp at 460 VAC, 265 A at 380/415 VAC

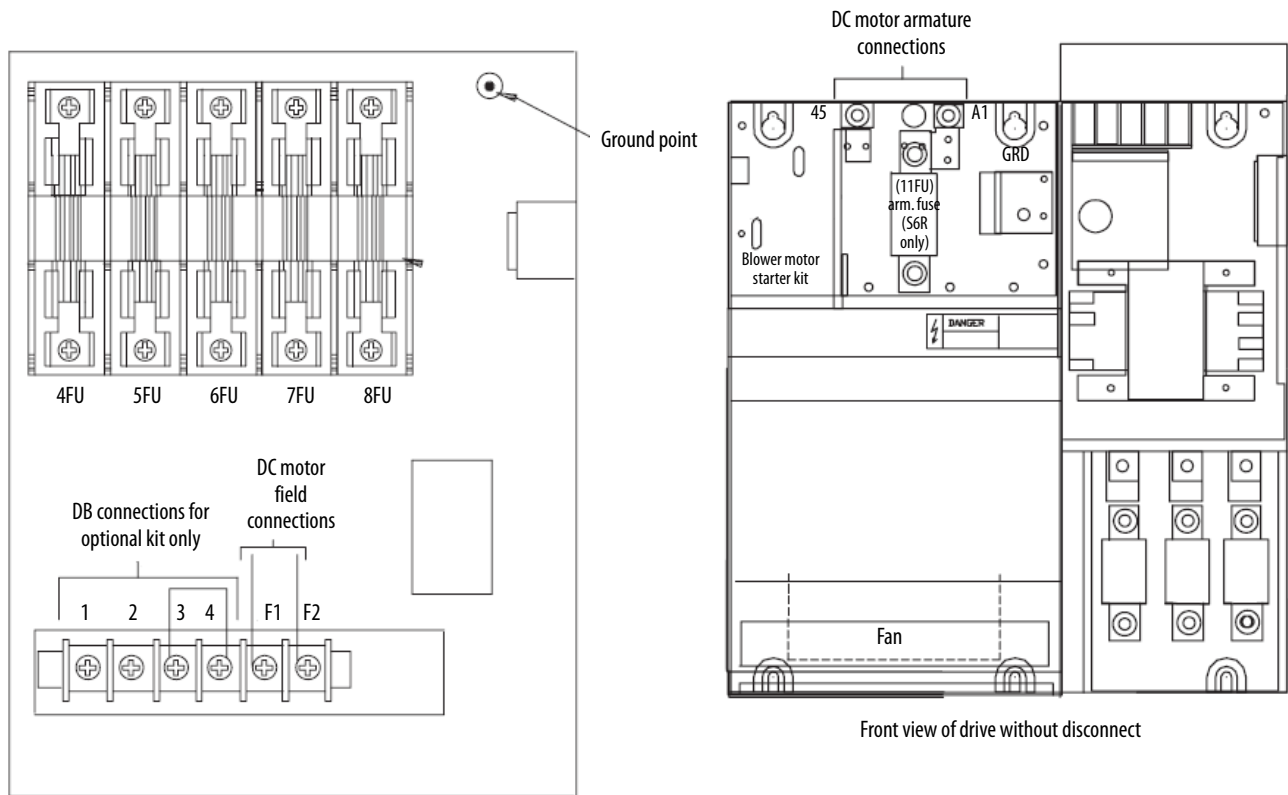


Figure 29 - 1397 - 100...150 Hp at 230 VAC, 200...300 Hp at 460 VAC

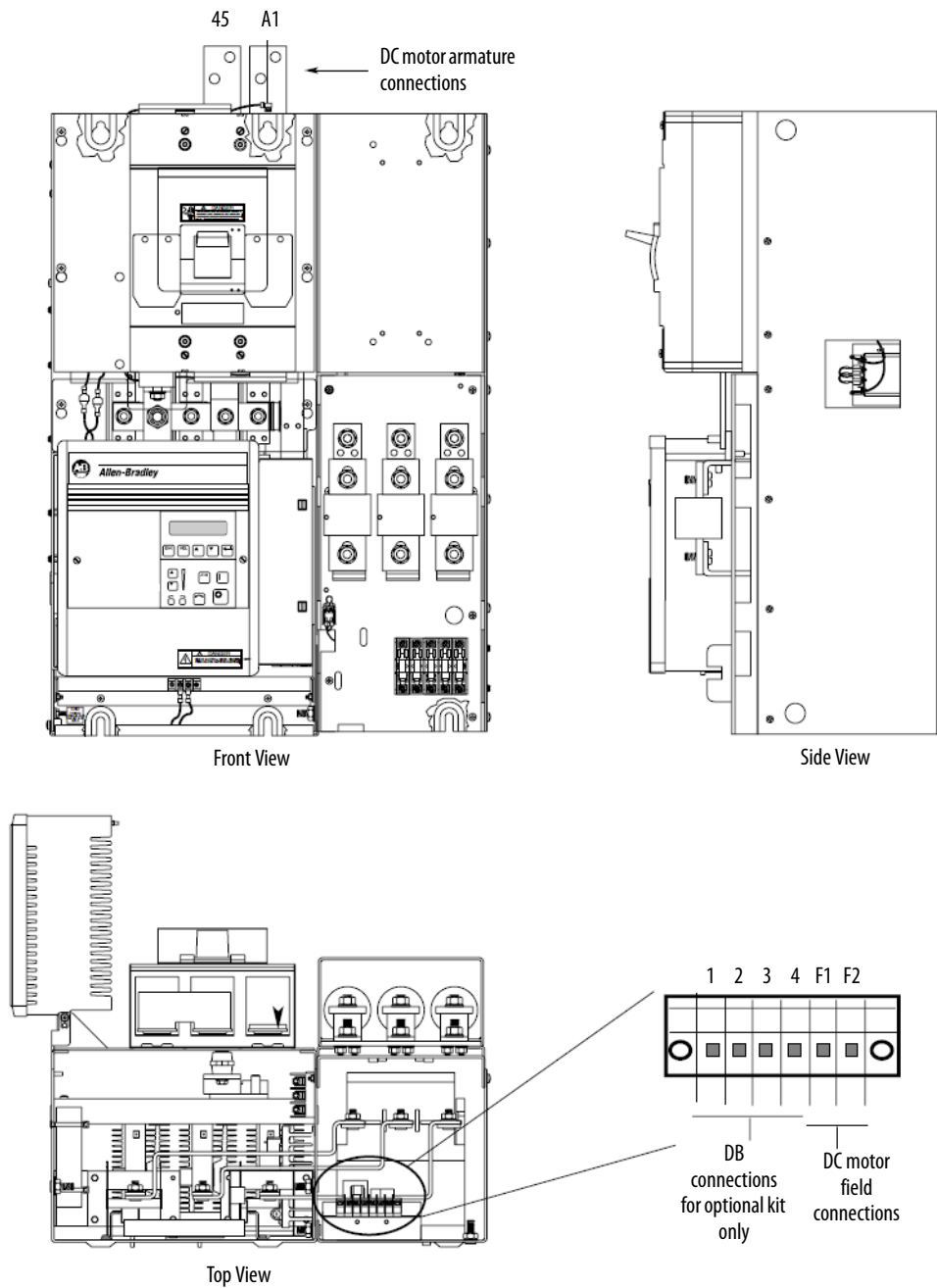
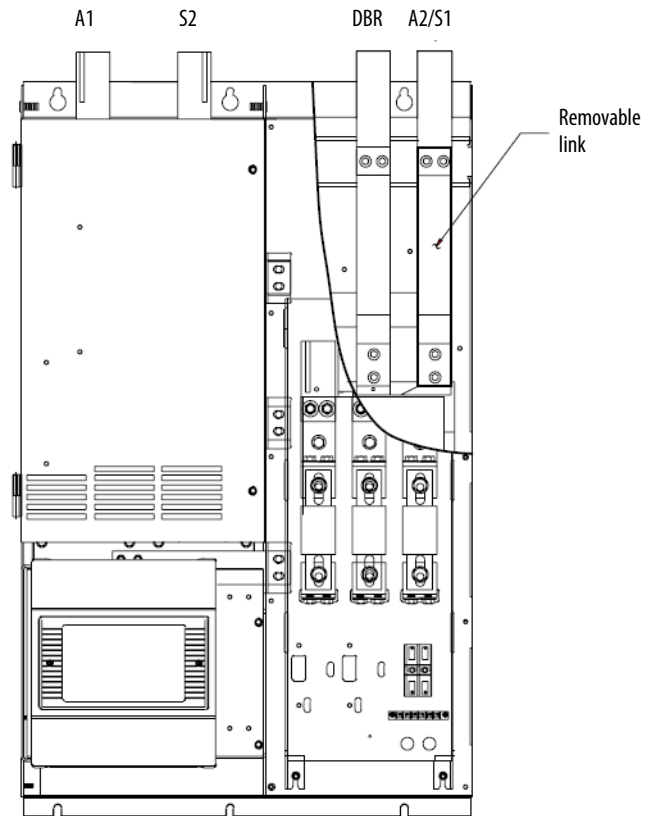


Figure 30 - 1397 - 400...600 Hp at 460 VAC



FlexPak 3000 AC Input Line Connections

Figure 31 - FlexPak 3000 - 1.5...30 Hp at 230 VAC, 3...60 Hp at 460 VAC, 7...110 A at 380/415 VAC

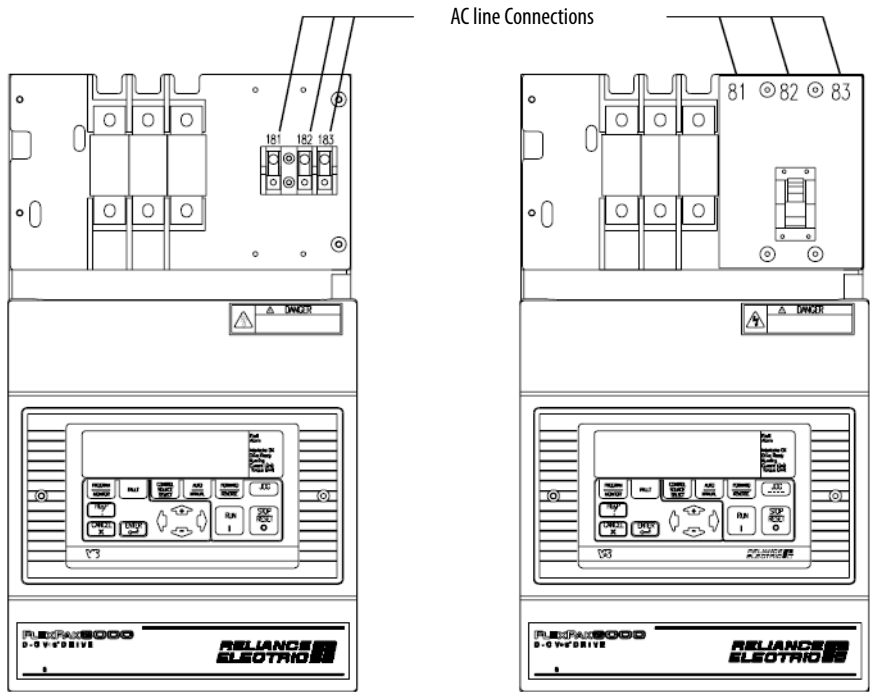


Figure 32 - FlexPak 3000 - 40...75 Hp at 230 VAC, 75...150 Hp at 460 VAC, 265 A at 380/415 VAC

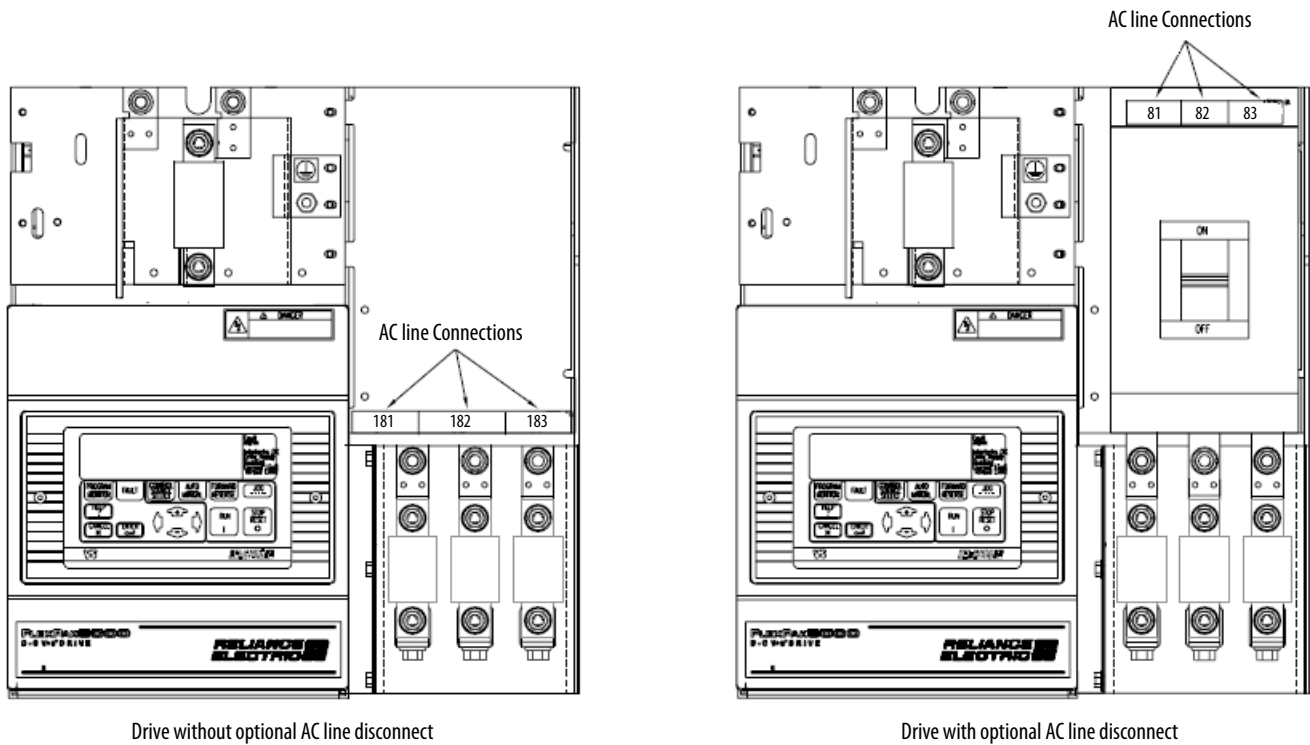


Figure 33 - FlexPak 3000 - 100...150 Hp at 230 VAC, 200...300 Hp at 460 VAC

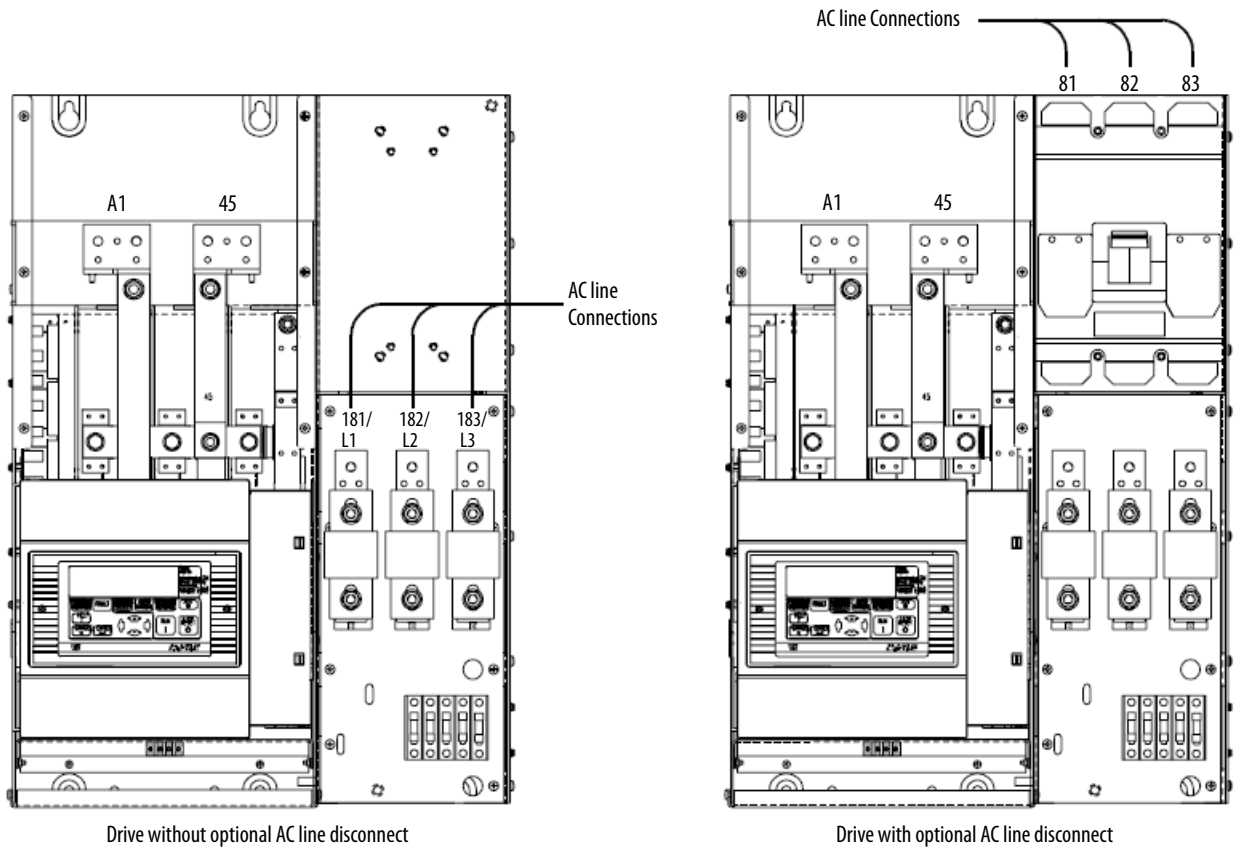


Figure 34 - FlexPak 3000 - 400...600 Hp at 460 VAC

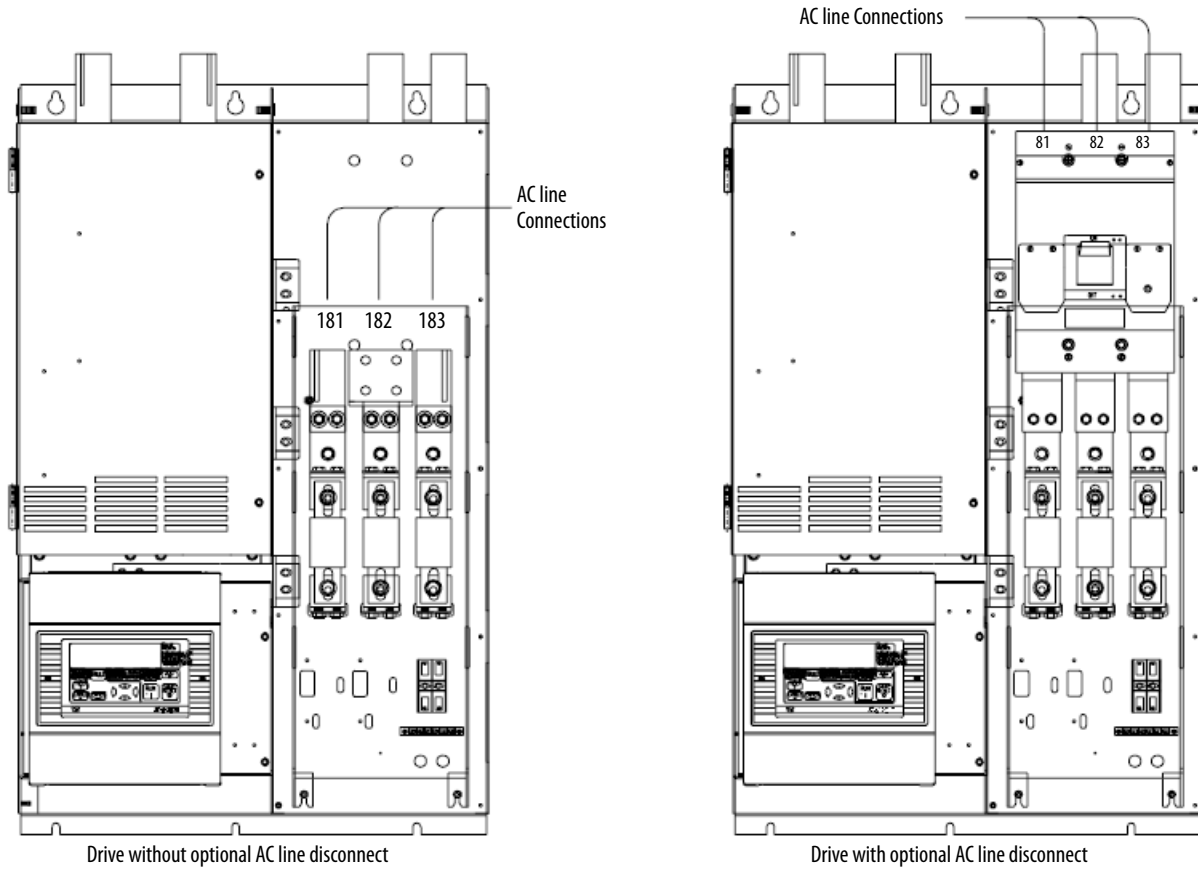


Figure 37 - FlexPak 3000 (S6) - 100...150 Hp at 230 VAC, 200...300 Hp at 460 VAC

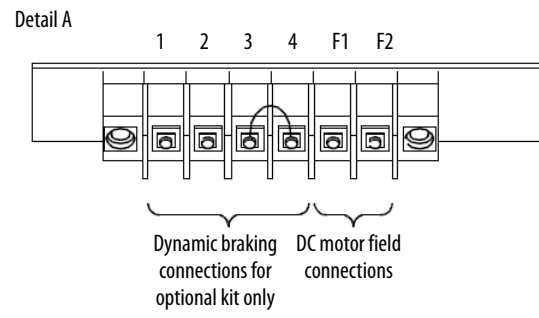
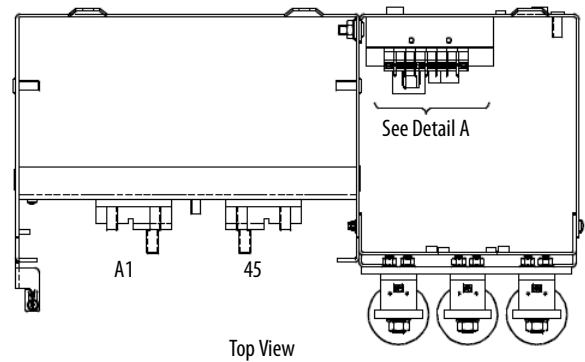
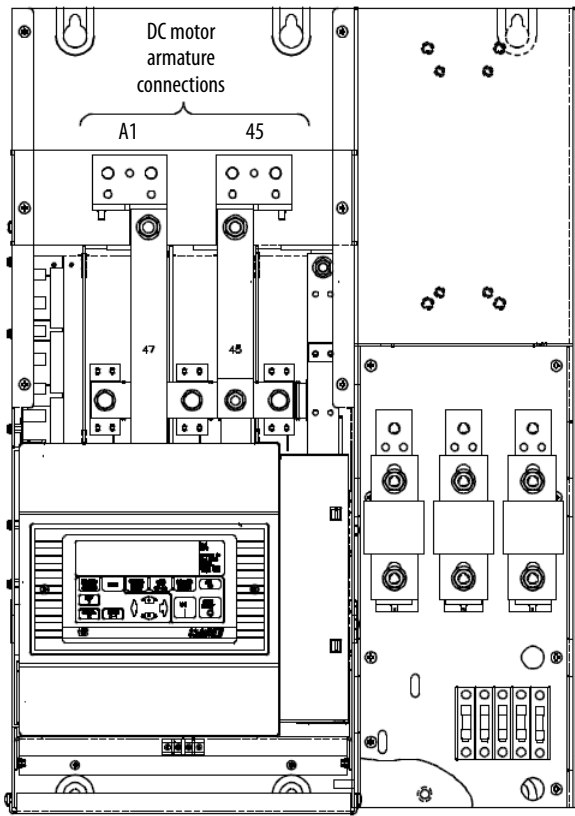


Figure 38 - FlexPak 3000 (S6R) - 100...150 Hp at 230 VAC, 200...300 Hp at 460 VAC

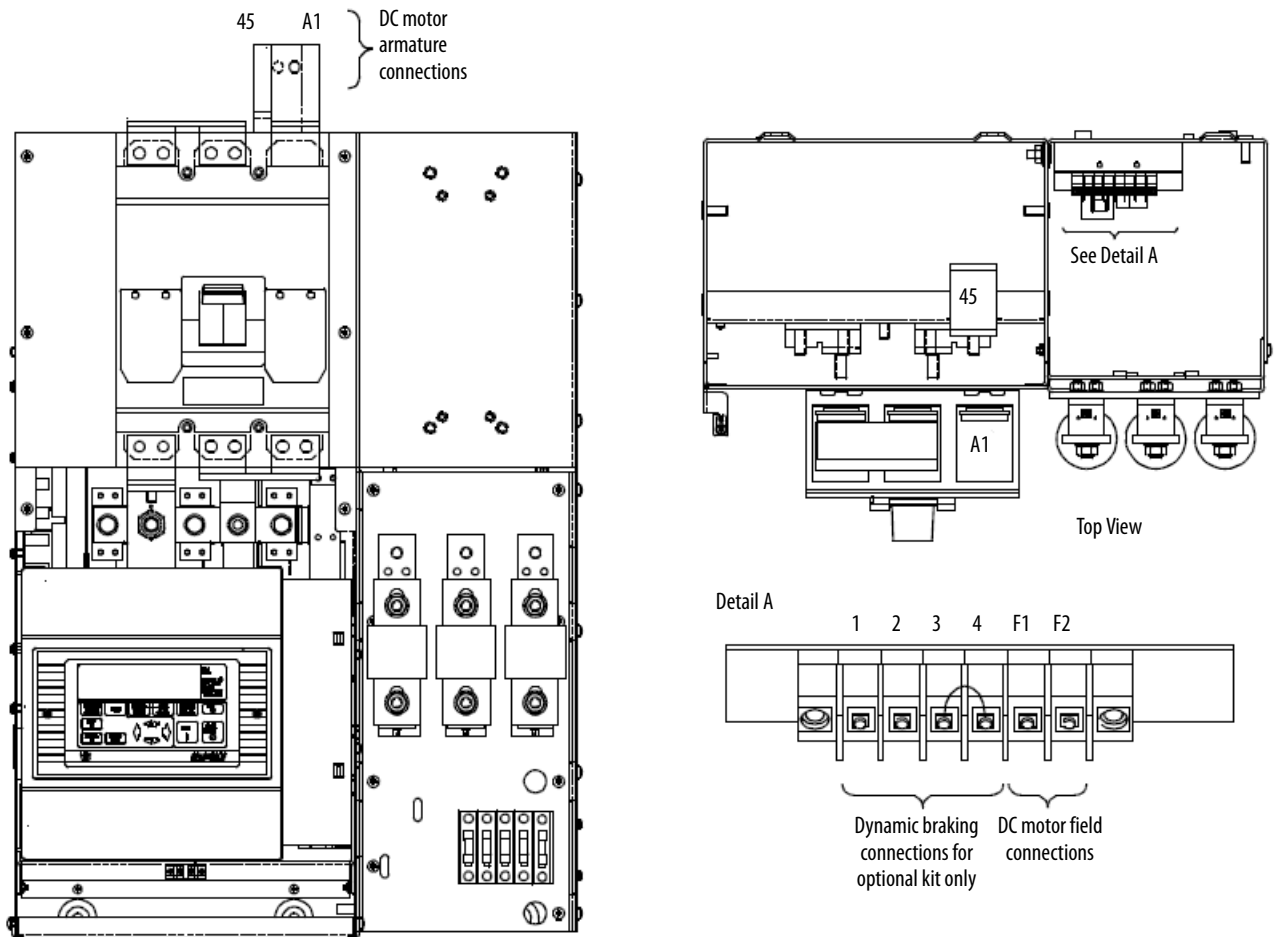
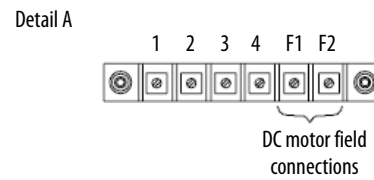
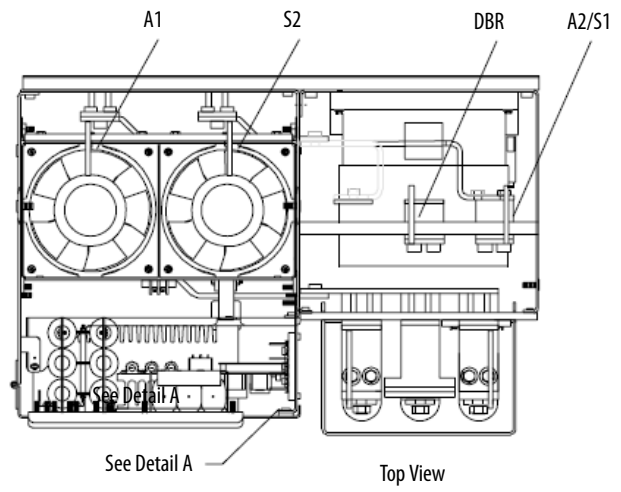
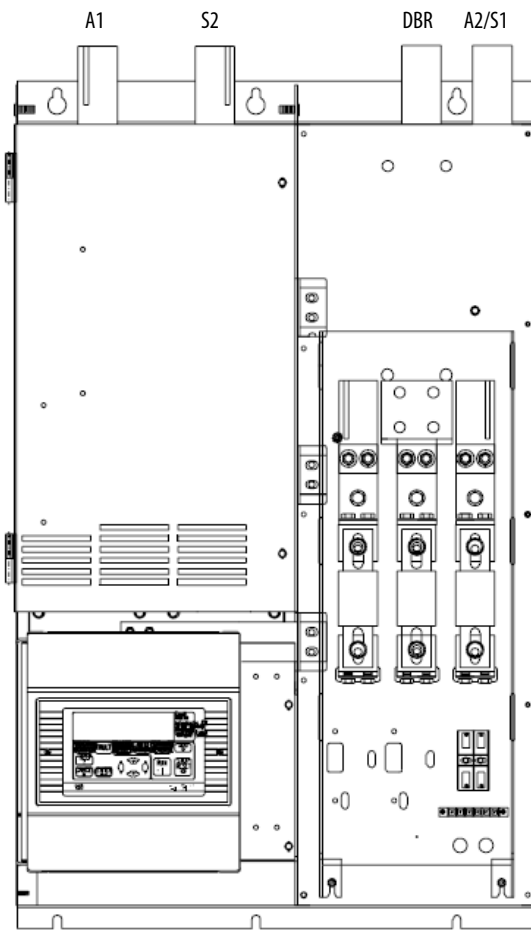


Figure 39 - 400...600 Hp at 460 VAC



PowerFlex DC Drive Power Wiring

AC Input Voltages

PowerFlex DC drives are rated for the following AC input voltages @ 50/60 Hz $\pm 5\%$:

Mains Circuit (Terminals U, V, W)

- 230V $\pm 10\%$, 3Ph
- 400V $\pm 10\%$, 3Ph
- 440V $\pm 10\%$, 3Ph
- 460V $\pm 10\%$, 3Ph
- 480V $\pm 10\%$, 3Ph
- 575V $\pm 10\%$, 3Ph
- 690V $\pm 10\%$, 3Ph

Field Circuit (Terminals U1, V1)

- 230V $\pm 10\%$, 1Ph
- 400V $\pm 10\%$, 1Ph
- 460V $\pm 10\%$, 1Ph

Control Circuit (Terminals U2, V2)

- 115V $\pm 15\%$ or 230V $\pm 15\%$, 1Ph

Note: For frame B and C drives only, a jumper must be placed between terminals SA-SB on the Switching Power Supply circuit board for the control circuits to work with 115V AC input. Refer to [Figure 59](#) on page 90 and [Figure 60](#) on page 90 for terminal block locations.

DC Output Voltages

The output voltages below take into account an AC input undervoltage within the stated tolerance limits and a voltage drop of 4% due to an AC input line reactor. It is the same as the rated armature voltage suggested for the connected motor.

Armature Circuit

AC Input Voltage (Terminals U, V, W)	DC Output Armature Voltage (Terminals C & D)	
	Two Quadrant Drive	Four Quadrant Drive
230V $\pm 10\%$, 3Ph	260V	240V
400V $\pm 10\%$, 3Ph	470V	420V
440V $\pm 10\%$, 3Ph	530V	460V
460V $\pm 10\%$, 3Ph	560V	480V
480V $\pm 10\%$, 3Ph	580V	500V
575V $\pm 10\%$, 3Ph	680V	600V
690V $\pm 10\%$, 3Ph	810V	720V

Field Circuit

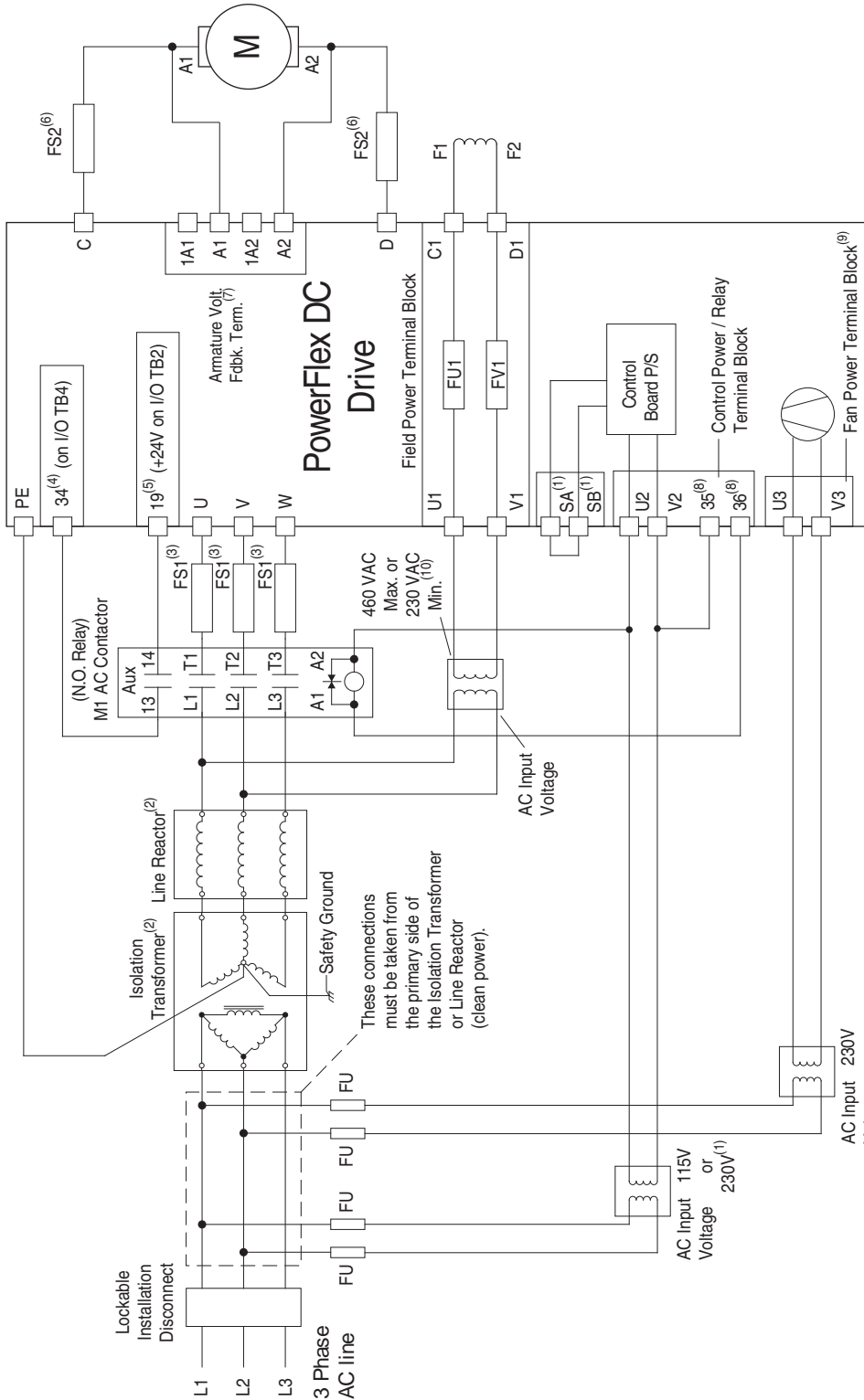
AC Input Voltage (Terminals U1 & V1)	DC Output Field Voltage ⁽¹⁾ (Terminals C1 & D1)	
	Fixed Field	Adjustable Field
230V $\pm 10\%$, 1Ph	200V	200V
400V $\pm 10\%$, 1Ph	310V	310V
460V $\pm 10\%$, 1Ph	360V	360V

(1) The max field voltage is equal to 0.85 x AC input line voltage

PowerFlex DC Drive Typical Power Wiring Diagrams

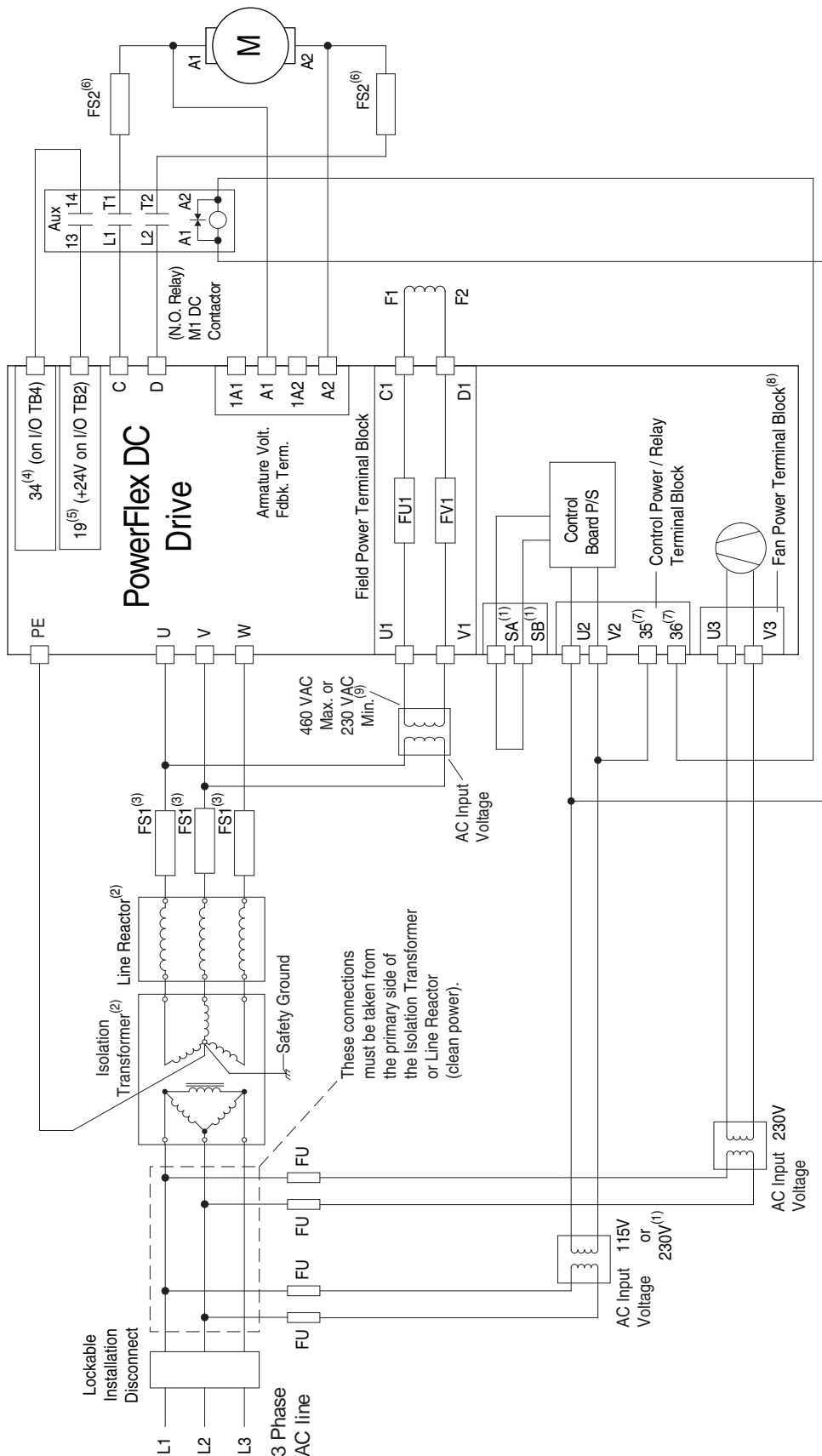
The following diagram represents recommended power wiring configurations:

Figure 40 - Power Wiring with AC Input Contactor



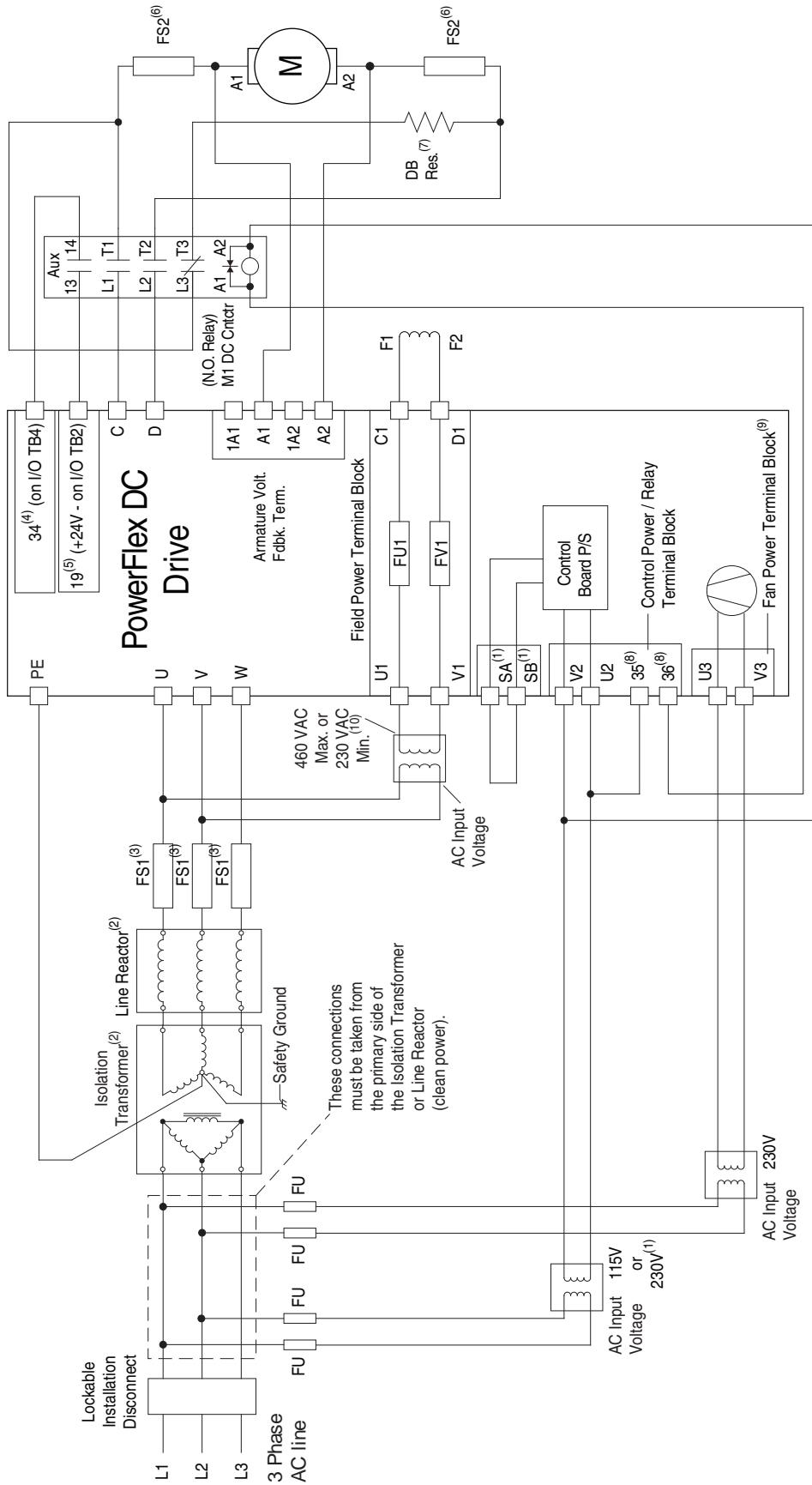
- (1) For frame B and C drives only, a jumper is required between terminals SA and SB for 115V AC control input power. See [PowerFlex DC Control Circuit Power Connections on page 87](#) for more information.
- (2) An Isolation Transformer and/or 3...5% impedance Line Reactor is required. If the Isolation Transformer provides the required 3...5% impedance, a Line Reactor is not required. See Appendix A in the PowerFlex Digital DC Drive User Manual, publication [20P-UM001](#), for recommendations.
- (3) AC input fuses for the armature converter are customer supplied for frame A and B drives and are internally mounted on frame C and D drives. See [PowerFlex DC Drives Circuit Protection on page 139](#) for fuse recommendations.
- (4) Par 140 [Digital In8 Sell set to 31" Contactor"
- (5) If using the +24V internal power supply, terminal 18 (24V common) must be jumpered to terminal 35 (digital input common).
- (6) Customer supplied armature output fuses are required on four quadrant and are recommended on two quadrant Frame A and B drives. See [PowerFlex DC Drives Circuit Protection on page 139](#) for fuse recommendations.
- (7) Optional armature voltage feedback sensing not required with AC contactor.
- (8) Par 1391 [ContactControl] = 1 "AC Cntr" and Par 1392 [Relay Out 1 Sel] = 25 "Contactor". **Important:** Terminal 35 and 36 are on the Control Power / Relay Terminal block, NOT the I/O terminal blocks. See [PowerFlex DC I/O Signal and Control Wiring on page 118](#) for locations.
- (9) Frame C & D drives only require an external power supply for the heatsink cooling fan. See [PowerFlex DC Frame C Heatsink Cooling Fans Power Supply Terminals on page 91](#) and [PowerFlex DC Frame D Heatsink Cooling Fans Power Supply Terminals on page 92](#) for more information.
- (10) See [PowerFlex DC Field Converter Connections on page 84](#).

Figure 41 - Power Wiring with DC Output Contactor



- (1) For frame B and C drives only, a jumper is required between terminals SA and SB for 115V AC input power. See [PowerFlex DC Control Circuit Power Connections on page 87](#) for more information.
- (2) An Isolation Transformer and/or 3...5% impedance, a Line Reactor is not required. See Appendix A in the PowerFlex Digital DC Drive User Manual, publication [20P-UM001](#), for recommendations.
- (3) AC input fuses for the armature converter are customer supplied for frame A and B drives and are internally mounted on frame C and D drives. See [PowerFlex DC Drives Circuit Protection on page 139](#) for fuse recommendations.
- (4) Par 140 [Digital In8 Sel] set to 31 "Contactor"
- (5) If using the +24V internal power supply, terminal 18 (24V common) must be jumpered to terminal 35 (digital input common).
- (6) Customer supplied armature output fuses are required on four quadrant and are recommended on two quadrant Frame A and B drives. See [PowerFlex DC Drives Circuit Protection on page 139](#) for fuse recommendations.
- (7) Par 1391 [ContactorControl] = 3 "DC Cntctr" and Par 1392 [Relay Out 1 Sel] = 25 "Contactor". **Important:** Terminal 35 and 36 are on the Control Power / Relay Terminal block, NOT the I/O terminal blocks. See [PowerFlex DC I/O Signal and Control Wiring on page 118](#) for locations.
- (8) Frame C & D drives only require an external power supply for the heatsink cooling fan. See [PowerFlex DC Frame C Heatsink Cooling Fans Power Supply Terminals on page 91](#) and [PowerFlex DC Frame D Heatsink Cooling Fans Power Supply Terminals on page 92](#) for more information.
- (9) See [PowerFlex DC Field Converter Connections on page 84](#).

Figure 42 - Power Wiring with DC Output/Dynamic Braking Contactor and a Dynamic Brake



PowerFlex DC - Armature Power Connections

Terminals	Description
U, V, W	Three phase AC input to the armature converter
C, D	DC output to the motor armature
PE	Safety ground

PowerFlex DC Armature Power Terminal and Ground (PE) Wire Sizes

Frame	Drive Current Rating Code ⁽¹⁾				Terminals	Wire Size and Type	Terminal Bolt Size (mm)	Tightening Torque N•m (lb•in)
	230V	460V	575	690				
A	7P0...055	4P1...052	–	–	U, V, W, C, D, PE	See "Cable and Wiring Recommendations" in the PowerFlex Digital DC Drive User Manual, publication 20P-UM001 .	5	6 (53)
	073...110	073...129	–	–			Terminal Block	12 (106)
B	All	All	–	–	U, V, W, C, D		10	25 (221)
					PE		8	15 (132.75)
C	All	All	–	–	U, V, W, C, D		10	25 (221)
					PE		8	15 (132.75)
D	All	All	All	All	U, V, W, C, D, PE		12	45 (398.2)

(1) See PowerFlex Digital DC Drive on page 28, positions 8, 9 and 10 for corresponding drive HP rating, armature amp rating and field amp rating.

Figure 43 - PowerFlex DC - Frame A Armature Terminal Block Location

Front View

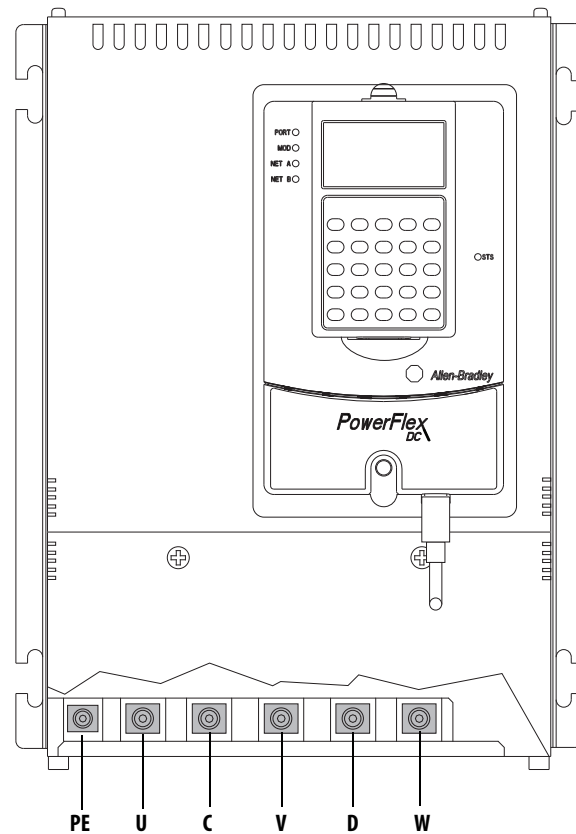
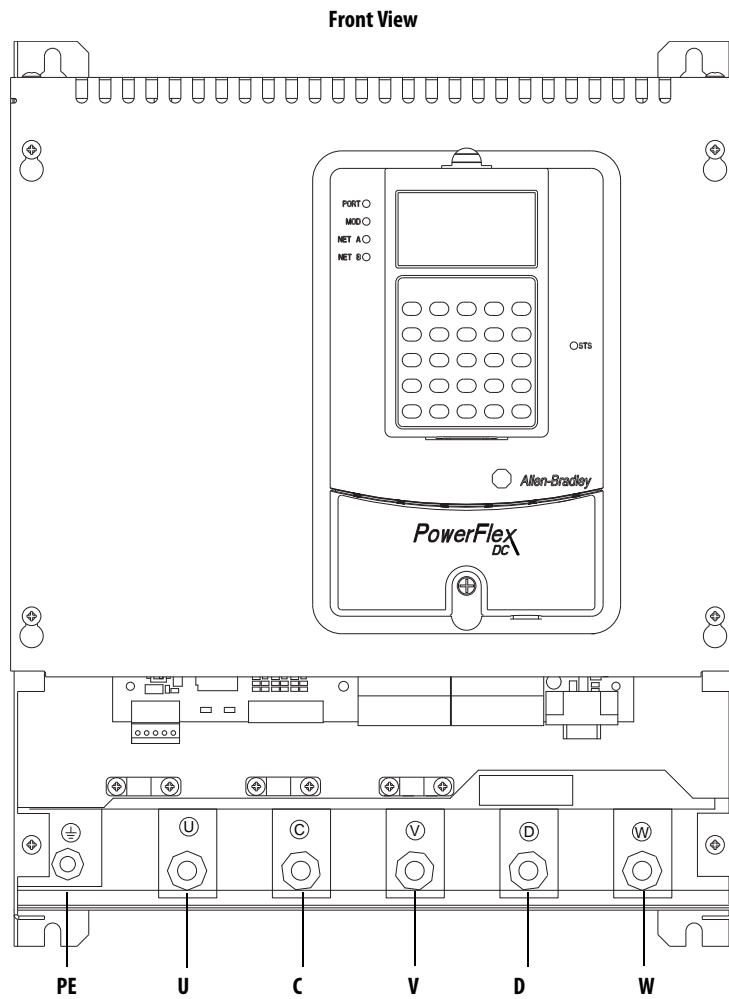


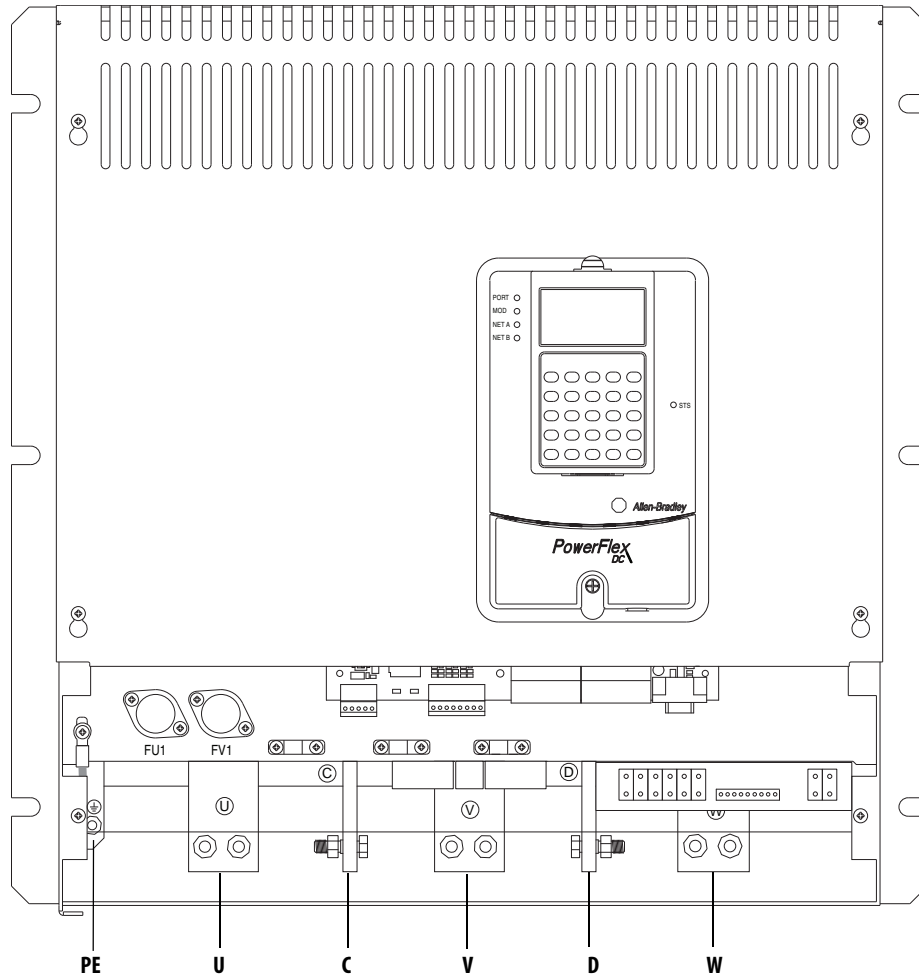
Figure 44 - PowerFlex DC - Frame B Armature Terminal Block Locations



Shown with lower protective cover removed.

Figure 45 - PowerFlex DC - Frame C Armature Terminal Block Locations

Front View

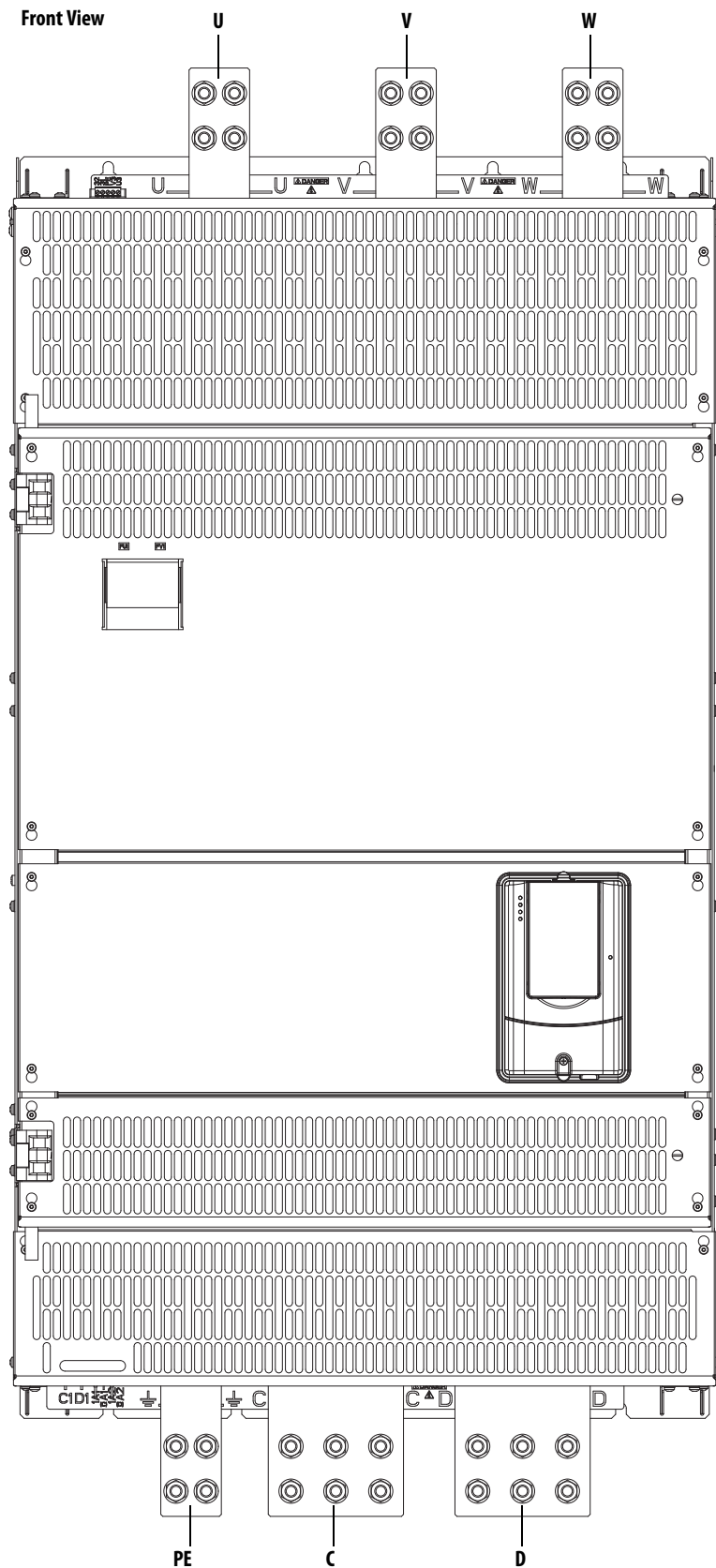


Shown with lower protective cover removed.

Figure 46 - PowerFlex DC - Frame D Armature Terminals Locations

IMPORTANT:

Certain frame D drives require the use of terminal adapter kits for terminals U, V, W, C, and D. Refer to Frame D Terminal Adapter Kits on page 161 for details.



PowerFlex DC - Armature Voltage Feedback Connections

When a DC output contactor or inverting fault breaker/fuse is used with the drive, and a speed feedback device (tachometer or encoder) is not used, the Armature Voltage Feedback terminals can be used to monitor the armature voltage at the motor regardless of the state of the contactor or inverting fault device. When this terminal block is not connected to the motor armature terminals, the terminals must be jumpered (as described in the table below) and the armature voltage feedback is monitored internally within the drive. In this case, when a DC contactor is used with the drive, a speed feedback device is not used, and the contactor opens, the drive will no longer receive the armature voltage feedback signal.

IMPORTANT By default, these terminals are jumpered - 1A1 to A1 and 1A2 to A2. If these terminals are not wired to the motor terminals, the jumpers must be installed.

Note that this terminal block is not present on drives shipped from the factory prior to those with v3.001 firmware installed. However, new Pulse Transformer boards shipped as replacement parts from the factory will contain this terminal block and can be used with any version of firmware.

Terminal	Description
1A1	Jumpered to A1 when internal armature voltage feedback is used. Not used when A1 is connected to motor terminal A1.
A1	Voltage feedback from motor terminal A1.
1A2	Jumpered to A2 when internal armature voltage feedback is used. Not used when A2 is connected to motor terminal A2.
A2	Voltage feedback from motor terminal A2.

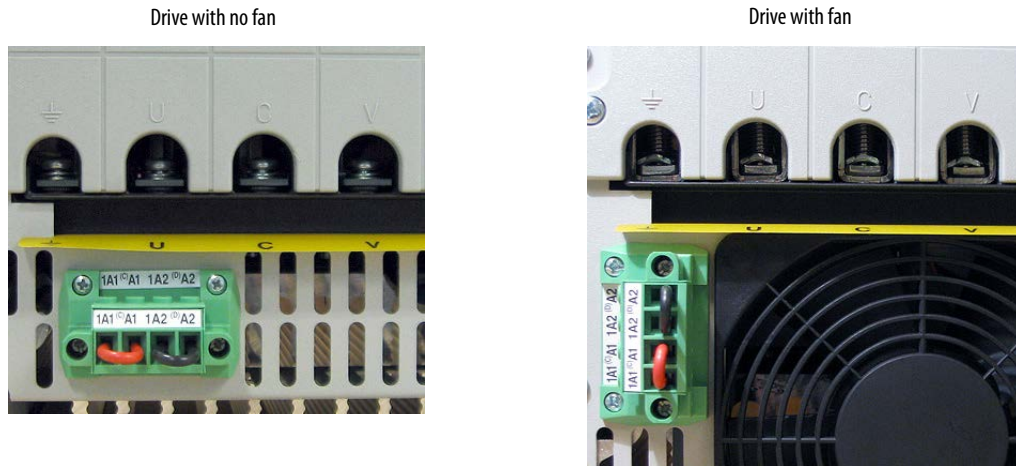
PowerFlex DC Armature Voltage Feedback Circuit Wire Sizes and Terminal Specifications

Frame	Terminals	Wire Size and Type ⁽¹⁾	Tightening Torque N•m (lb•in)
A, B & C	1A1, A1, 1A2, A2	24...10 AWG/kcmils	0.5...0.6 (4.4...5.3)
D		22...8 AWG/kcmils	0.8...1.6 (7.1...14.2)

(1) Wire with an insulation rating of 600V or greater is recommended. See "Cable and Wiring Recommendations" in the PowerFlex Digital DC Drive User Manual, publication [20P-UM001](#), for cable spacing information.

Figure 47 - PowerFlex DC - Frame A Armature Feedback Circuit Terminal Block Location

Bottom of View of Drives



Shown with terminals jumpered for internal armature voltage feedback.

Figure 48 - PowerFlex DC - Frame B Armature Voltage Feedback Circuit Terminal Block Location



Top of Drive

Shown with terminals jumpered for internal armature voltage feedback.

Figure 49 - PowerFlex DC - Frame C Armature Voltage Feedback Circuit Terminal Block Location

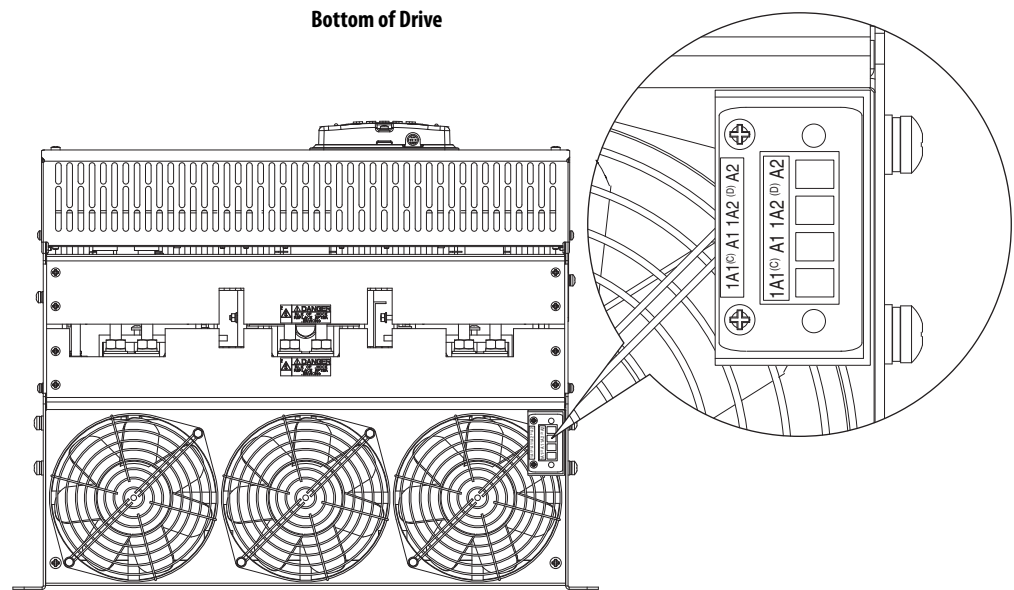
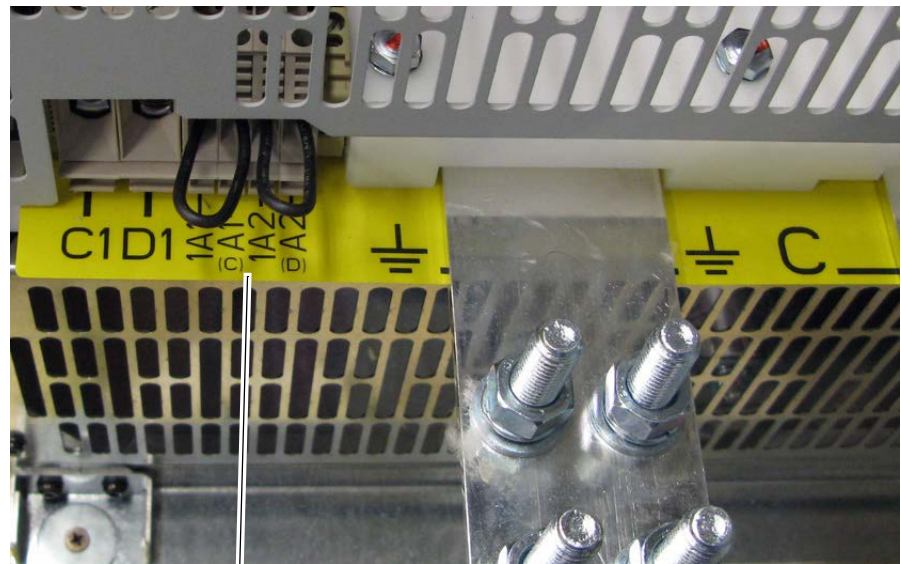


Figure 50 - PowerFlex DC - Frame D Armature Voltage Feedback Circuit Terminal Block Location



Shown with terminals jumpered for internal armature voltage feedback.

**Bottom of Drive,
Left Side**

PowerFlex DC Field Converter Connections

For 575V or 690V AC input drives only, a step down transformer with either a 230 VAC secondary, for a 150V motor field, or 460 VAC, for a 300V motor field, is required before the input to the field control circuit (terminals U1, V1).

Also, If the rated voltage of the DC motor field is not compatible with the field DC output voltage of the drive, an external field control transformer must be used. Refer to the following example for transformer selection information.

Example: 10 Hp, 240V Armature, 17.2A, 240V Field, 2.0 A motor

- a. The field control transformer must have a 230V primary, a 460V secondary, and be single-phase, 60 Hz
- b. $kVA = 2 \text{ A} \times 460\text{VAC} \times 1.5 = 1.38 \text{ kVA}$ (1.5 kVA is closest)

In addition, the following configuration must to completed in the PowerFlex DC drive:

- c. Control board DIP switch S14 must be set to select a value of 2 A.
- d. Parameter 374 [Drv Fld Brdg Cur] must be programmed to match DIP switch S14 = “2.”
- e. Parameter 280 [Nom Mtr Fld Amps] must be programmed to the rated motor nameplate field current “2.”

PowerFlex DC Field Converter Terminal Designations

Terminal	Description
U1, V1	Single-phase AC line input power to the field circuit.
C1, D1	DC output power to the motor field.

PowerFlex DC Frames A...C Field Circuit Wire Sizes and Terminal Specifications

Terminals	Wire Size and Type ⁽¹⁾	Tightening Torque N•m (lb•in)
U1, V1, C1, D1	24...10 AWG/kcmils	0.5...0.8 (4.4...7.1)

(1) See “Cable and Wiring Recommendations” in the PowerFlex Digital DC Drive User Manual, publication [20P-UM001](#), for cable spacing information.

PowerFlex DC Frame D Field Circuit Wire Sizes and Terminal Specifications

Drive Current Rating Code ⁽¹⁾				Terminals	Wire Size ⁽²⁾	Tightening Torque N•m (lb•in)
230V	460V	575V	690V			
875	830	810	678	U1, V1, C1, D1	6 AWG	4.0 (35.4)
1K0	996	1K0	791			
–	–	1K2	904			
–	–	1K3	1K0			
–	–	1K6	–			
–	1K1	–	1K1			
–	1K3	–	1K2		2 AWG	
–	1K4	–	1K4			
–	–	–	1K5			
–	–	–	–			

(1) See PowerFlex Digital DC Drive on page 28, positions 8, 9 and 10 for corresponding drive HP rating, armature amp rating and field amp rating.
 (2) See “Cable and Wiring Recommendations” in the PowerFlex Digital DC Drive User Manual, publication [20P-UM001](#), for cable spacing information.

Figure 51 - PowerFlex DC - Frame A Field Circuit Terminal Block Location

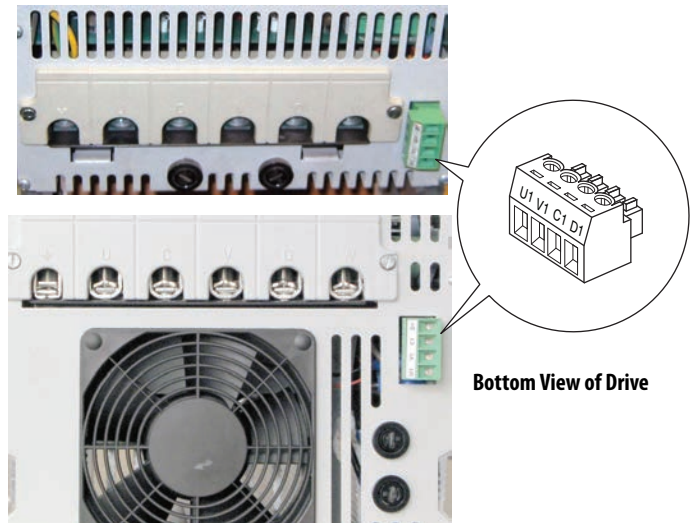


Figure 52 - PowerFlex DC - Frame B Field Circuit Terminal Block Location

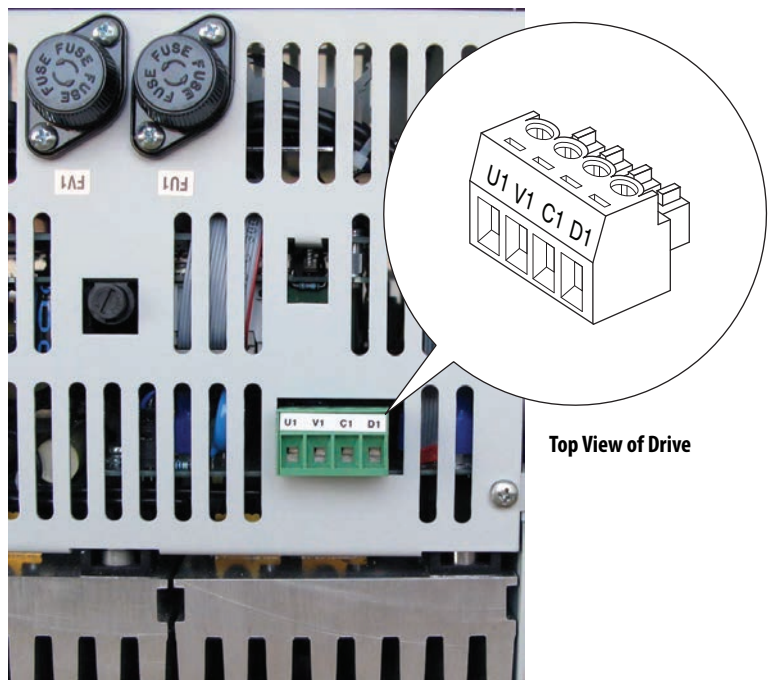
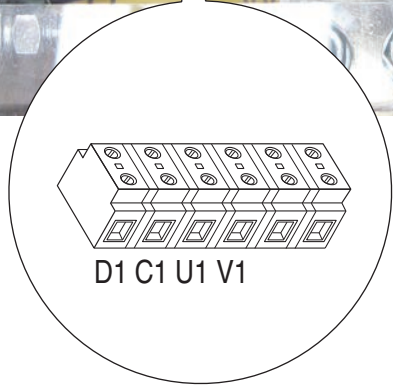
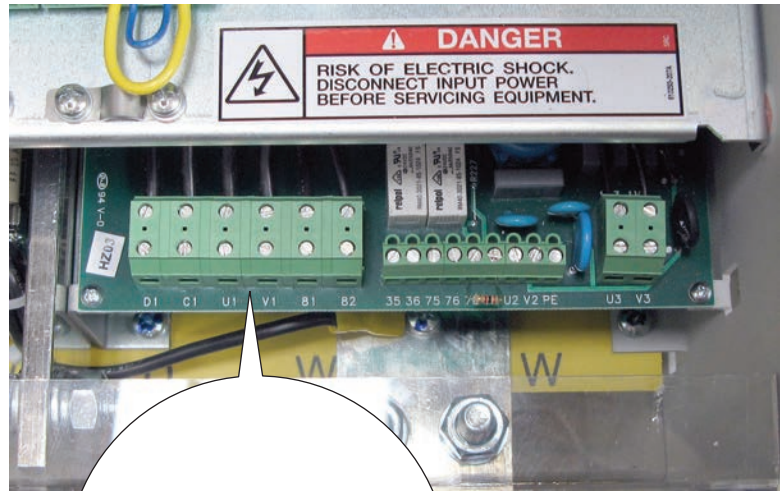
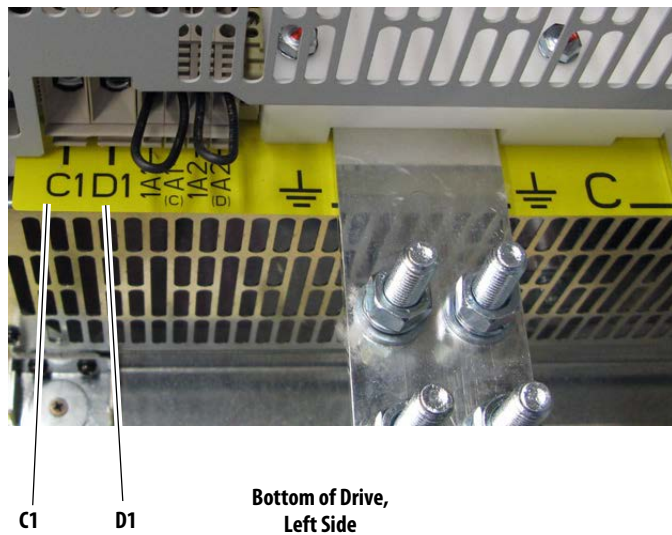
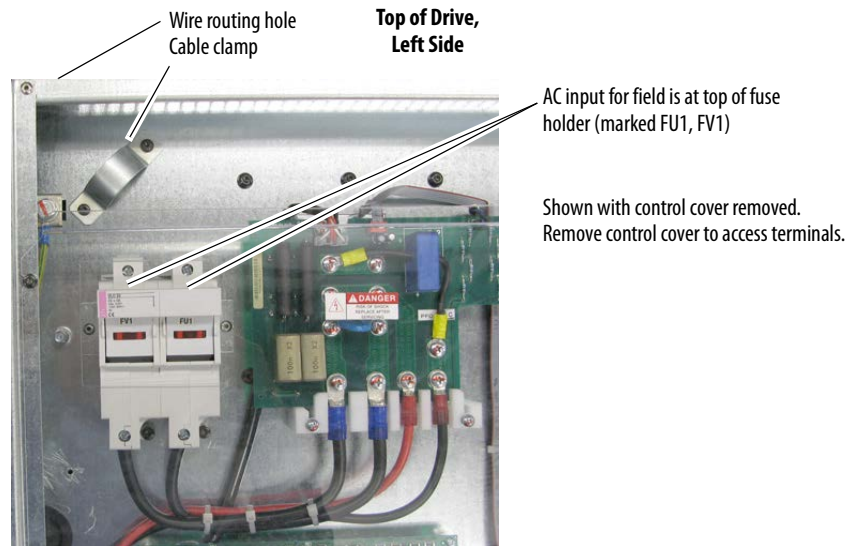


Figure 53 - PowerFlex DC - Frame C Field Circuit Terminal Block Location



Front View of Drive

Figure 54 - PowerFlex DC - Frame D Field Circuit Terminal Block Location



PowerFlex DC Control Circuit Power Connections

The control circuit must be powered by an external 230V AC or 115V AC single phase power supply. For frame B and C drives only, a jumper is required between terminals SA and SB for 115V AC control input power. Refer to [Figure 59](#) on page 90 and [Figure 60](#) on page 90 for terminal block locations.

Control Circuit Terminal Designations

Terminal	Description
U2	Single-phase AC power for the control circuits.
V2	

Control Circuit Wire Sizes

Terminals	Wire Size and Type ⁽¹⁾			Tightening Torque N-m (lb-in)
	Flexible (mm ²)	Multi-core (mm ²)	AWG	
U2, V2	0.14...1.5	0.14...2.5	26...14	0.5 (4.4)
PE	2.5...10	2.5...10	12...8	2.0 (18.0)

(1) See "Cable and Wiring Recommendations" in the PowerFlex Digital DC Drive User Manual, publication [20P-UM001](#), for cable spacing information.

Figure 55 - PowerFlex DC - Frame A Control Circuit Terminal Block Location

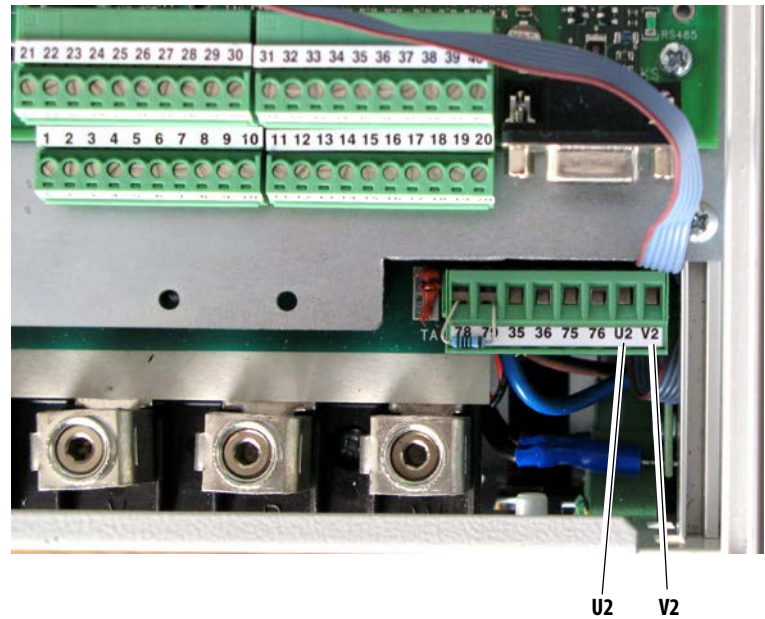


Figure 56 - PowerFlex DC - Frame B Control Circuit Terminal Block Location

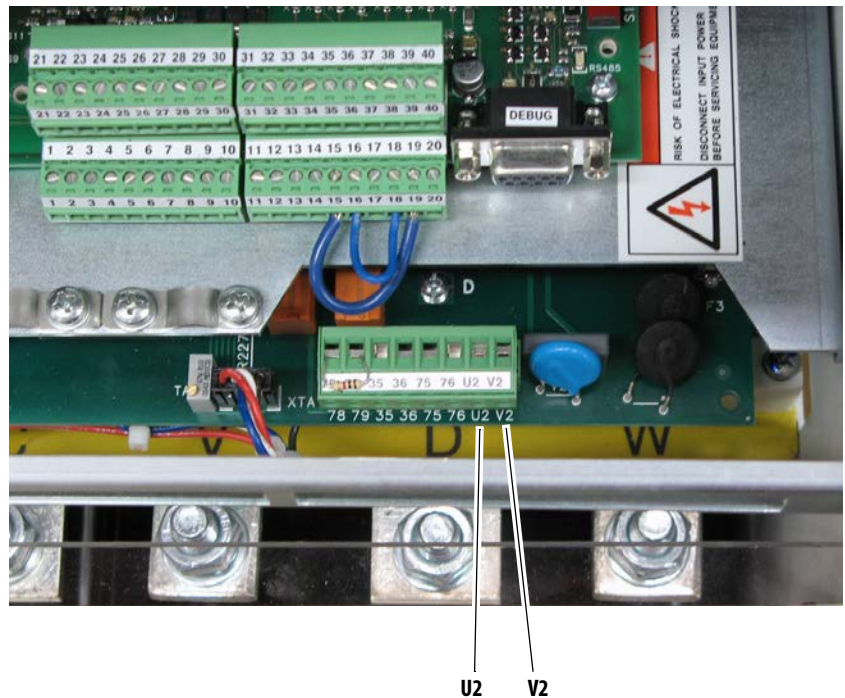


Figure 57 - PowerFlex DC - Frame C Control Circuit Terminal Block Location

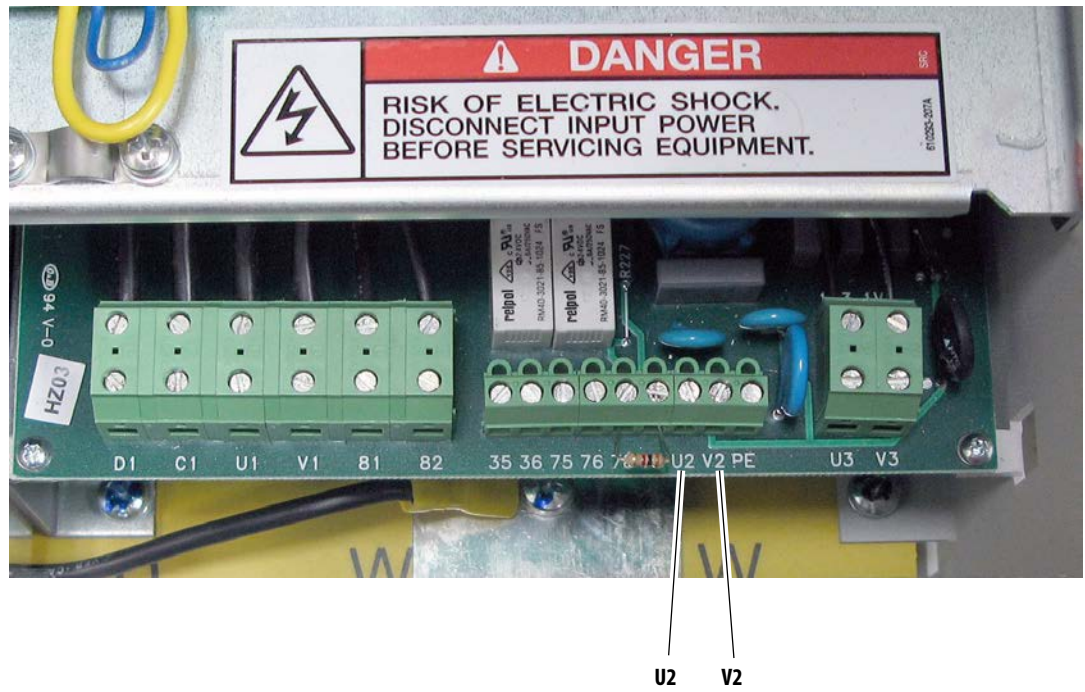


Figure 58 - PowerFlex DC - Frame D Control Circuit Terminal Block Location

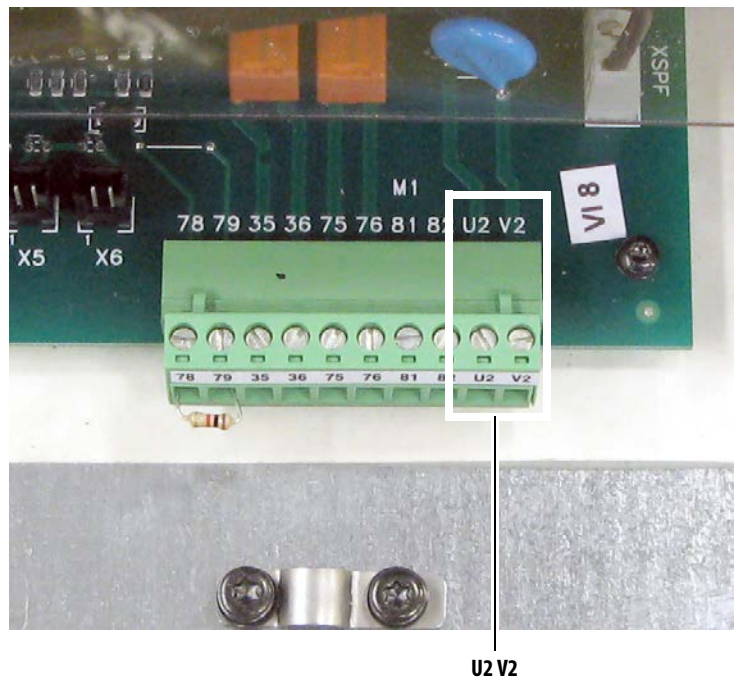
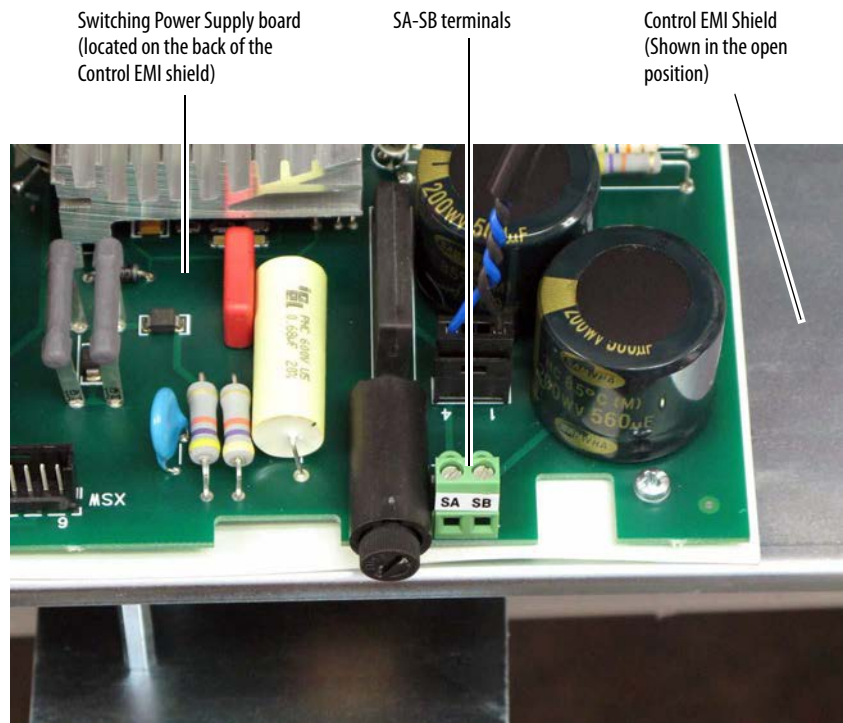


Figure 59 - PowerFlex DC - Frame B drives SA-SB Terminal Block Location



Figure 60 - PowerFlex DC - Frame C Drives SA-SB Terminal Block Location



PowerFlex DC Frame C Heatsink Cooling Fans Power Supply Terminals

Frame C drives require an external 230V AC power supply for the heatsink cooling fans. The power supply connections must be taken from the primary side of the installed Isolation Transformer or Line Reactor (clean power). See PowerFlex DC Drive Typical Power Wiring Diagrams on page 74.

In addition, the fan power input terminals U3 and V3 are required to be short circuit protected. This protection can be provided by using a circuit breaker. The circuit breaker must be selected to survive the short circuit available current of the feeder source for this circuit and the inrush current of the fan.

The rating of the circuit breaker should be sized mainly to protect the wiring from the circuit breaker connections to terminals U3 and V3, and not nuisance trip or blow from the inrush current.

Frame C Heatsink Cooling Fans Terminal Designations

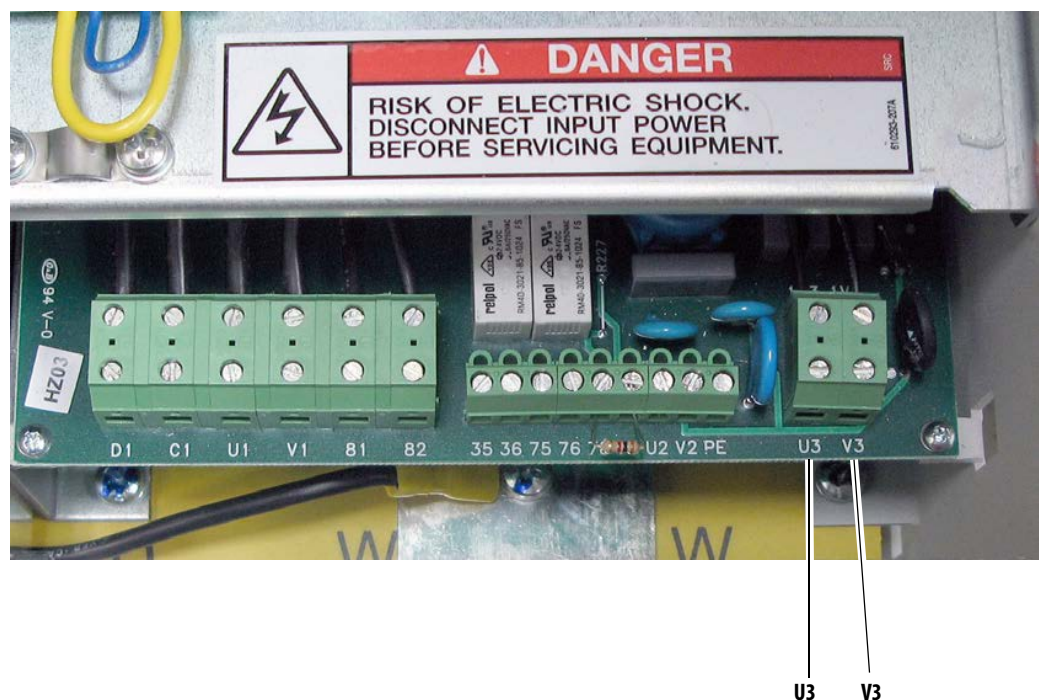
Terminal	Description	Maximum Voltage	Maximum Current
U3	Single-phase AC input power for cooling fans.	230V AC	1 A
V3			

Frame C Heatsink Cooling Fans Wire Sizes and Terminal Specifications

Terminals	Wire Size and Type ⁽¹⁾			Tightening Torque N•m (lb•in)
	Flexible (mm ²)	Multi-core (mm ²)	AWG	
U3, V3	0.14...1.5	0.14...2.5	26...16	0.4 (3.5)

(1) See "Cable and Wiring Recommendations" in the PowerFlex Digital DC Drive User Manual, publication [20P-UM001](#), for cable spacing information.

Figure 61 - Frame C Heatsink Cooling Fan Terminal Block Location



PowerFlex DC Frame D Heatsink Cooling Fans Power Supply Terminals

Frame D drives require an external 230V AC power supply for the heatsink cooling fan. The power supply connections must be taken from the primary side of the installed Isolation Transformer or Line Reactor (clean power). See PowerFlex DC Drive Typical Power Wiring Diagrams on page 74.

The fan power input terminals U3 and V3 are required to be short circuit protected. This protection can be provided by using a circuit breaker. The circuit breaker must be selected to survive the short circuit available current of the feeder source for this circuit and the inrush current of the fan.

The rating of the circuit breaker should be sized mainly to protect the wiring from the circuit breaker connections to terminals U3 and V3, and not nuisance trip or blow from the inrush current.

In addition, a N.C. contact (at terminals 31 and 32) can be connected to an external device to provide indication of a fan supply failure or can be wired to drive digital input terminals configured for 14 “Aux Fault” (via Pars133...144).

Frame D Heatsink Cooling Fan Terminal Designations

Terminal	Description	Maximum Voltage	Maximum Current
U3	Single-phase AC input power for cooling fans.	230V AC	2.4...3.3 A (50/60 Hz)
V3			
31	Normally closed contact.	250V AC	1 A
32			
PE	Safety ground		

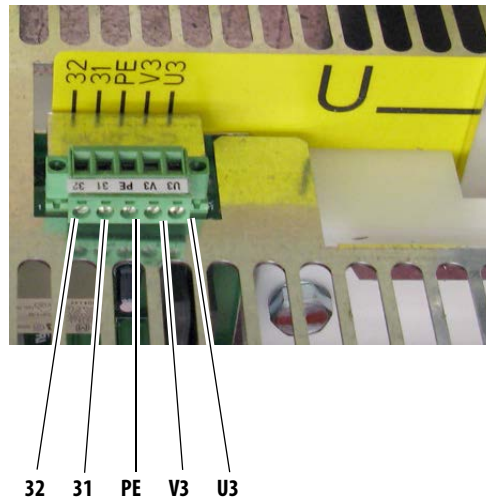
Frame D Heatsink Cooling Fan Signal Wire Sizes and Terminal Specifications

Terminals	Wire Size and Type ⁽¹⁾			Tightening Torque N•m (lb•in)
	Flexible (mm ²)	Multi-core (mm ²)	AWG	
U3, V3, 31, 32, PE	0.14...1.5	0.14...2.5	28...12	0.5...0.6 (4.4...5.3)

(1) See “Cable and Wiring Recommendations” in the PowerFlex Digital DC Drive User Manual, publication 20P-UM001, for cable spacing information.

Figure 62 - Frame D Heatsink Cooling Fan Terminal Block Location

Top of Drive, Left Side



PowerFlex DC Frame C and D Armature Fuse Signal Terminals

Terminals 81 and 82 on frame C and D drives are connected to the internal armature circuit protection fuses and can be connected to an external device to provide indication that the fuses have opened. Alternatively, terminals 81 and 82 can be wired to drive digital input terminals configured for 64 “Invert Flt” (via Pars 133...144).

Armature Fuse Signal Terminal Designations

Terminal	Description	Maximum Voltage	Maximum Current
81	Internal armature fuse intervention signal.	250V AC	1 A
82			

Armature Fuse Signal Wire Size and Terminal Specifications

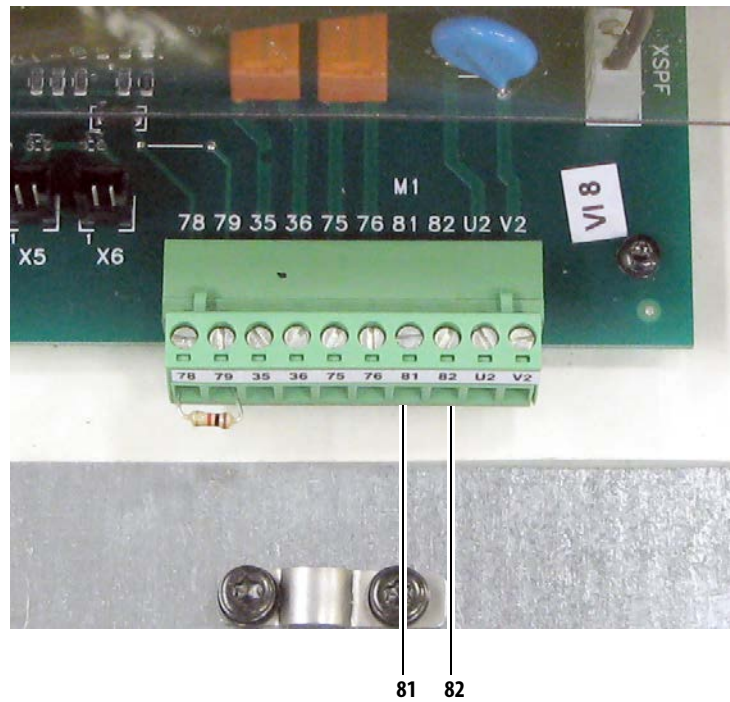
Terminals	Wire Size and Type ⁽¹⁾			Tightening Torque N•m (lb•in)
	Flexible (mm ²)	Multi-core (mm ²)	AWG	
81, 82	0.14...1.5	0.14...2.5	26...16	0.4 (3.5)

(1) See “Cable and Wiring Recommendations” in the PowerFlex Digital DC Drive User Manual, publication [20P-UM001](#), for cable spacing information.

Figure 63 - Frame C Internal Armature Fuse Signal Terminal Block Location



Figure 64 - Frame D Internal Armature Fuse Signal Terminal Block Location



Control and Feedback Comparisons

Bulletin 1395 Digital DC Drive

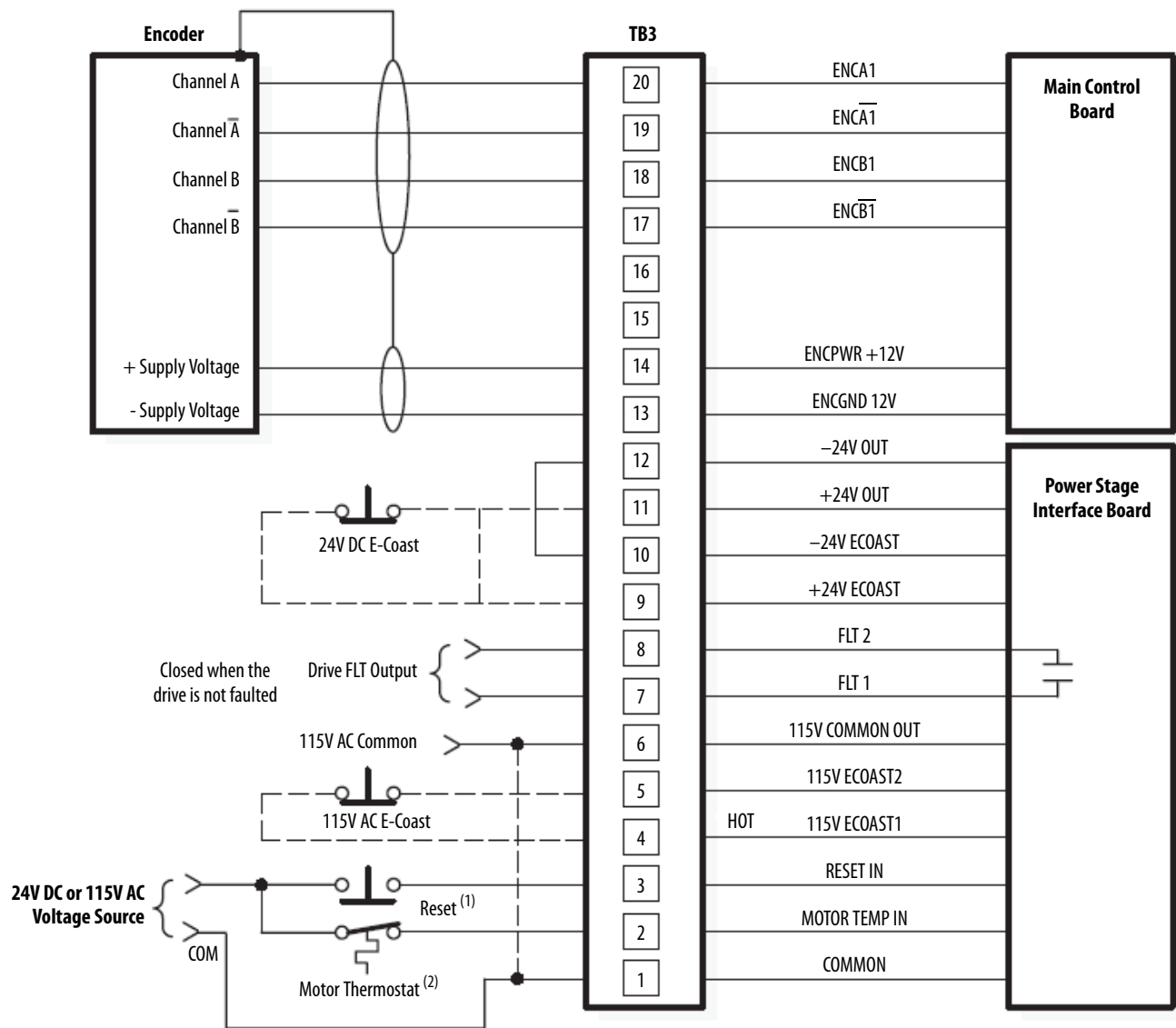
Input and output signals can be 24V DC, but require a separate 24V DC power supply in addition to basic 115V AC control circuit requirement.

All control wiring to external devices except for contactor control is terminated in the drive at terminal block TB3. Signal definitions for terminals 1...20 are predetermined and are independent of the application. [Figure 65](#) on page [95](#) illustrates these terminals with their signal definitions.

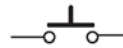
TB3 is attached to a mounting rail at the bottom of the drive chassis. It provides a wiring connection for customer supplied control and signal devices, along with encoder interface and auxiliary peripheral devices.

See the 1395 Digital DC Drive, User Manual, publication [1395-UM003](#) for more details.

Figure 65 - 1395 - TB3 Terminal Descriptions



(1) If parameter 620 = 0, then the Reset input requires a N.O. push button as shown here:
Closing the push button causes System Reset to occur.
This is the default value for the 1395.



If parameter 620 = 1, then the Normal Stop input requires a N.C. push button as shown here.
Opening the push button causes Normal Stop to occur.



(2) If no thermostat is used, 115V AC or 24V DC must still be applied to TB3, terminal 2.

Note: If a N.C. push button is used and parameter 620 = 0, the drive will be in a continuous reset condition.
If a N.O. push button is used and parameter 620 = 1, a Stop will be present in [Logic Cmd 1], parameter 150.

1395 Discrete Adapter Board

External wiring is connected to the terminal block at the bottom of the 1395 drive enclosure. Terminals 23 through 52 are reserved for wiring the Discrete Adapter board to external I/O devices. See the 1395 Digital DC Drive, User Manual, publication [1395-UM003](#), or Bulletin 1395 Discrete Adapter Board Installation and Operation Manual, publication [1395-IN001](#), for more details.

Figure 66 - 1395 Discrete Adapter Board Hardware Connection Diagram

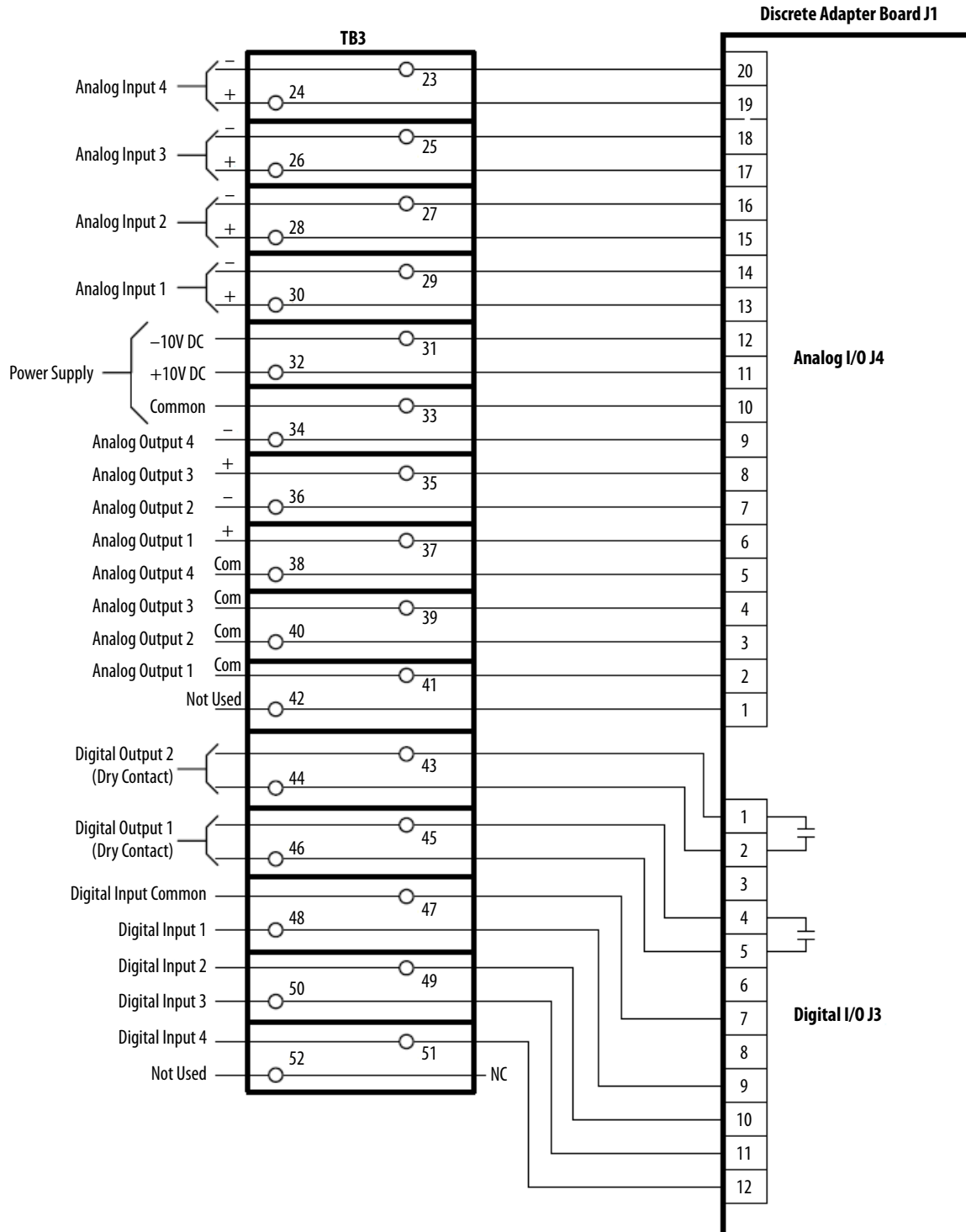
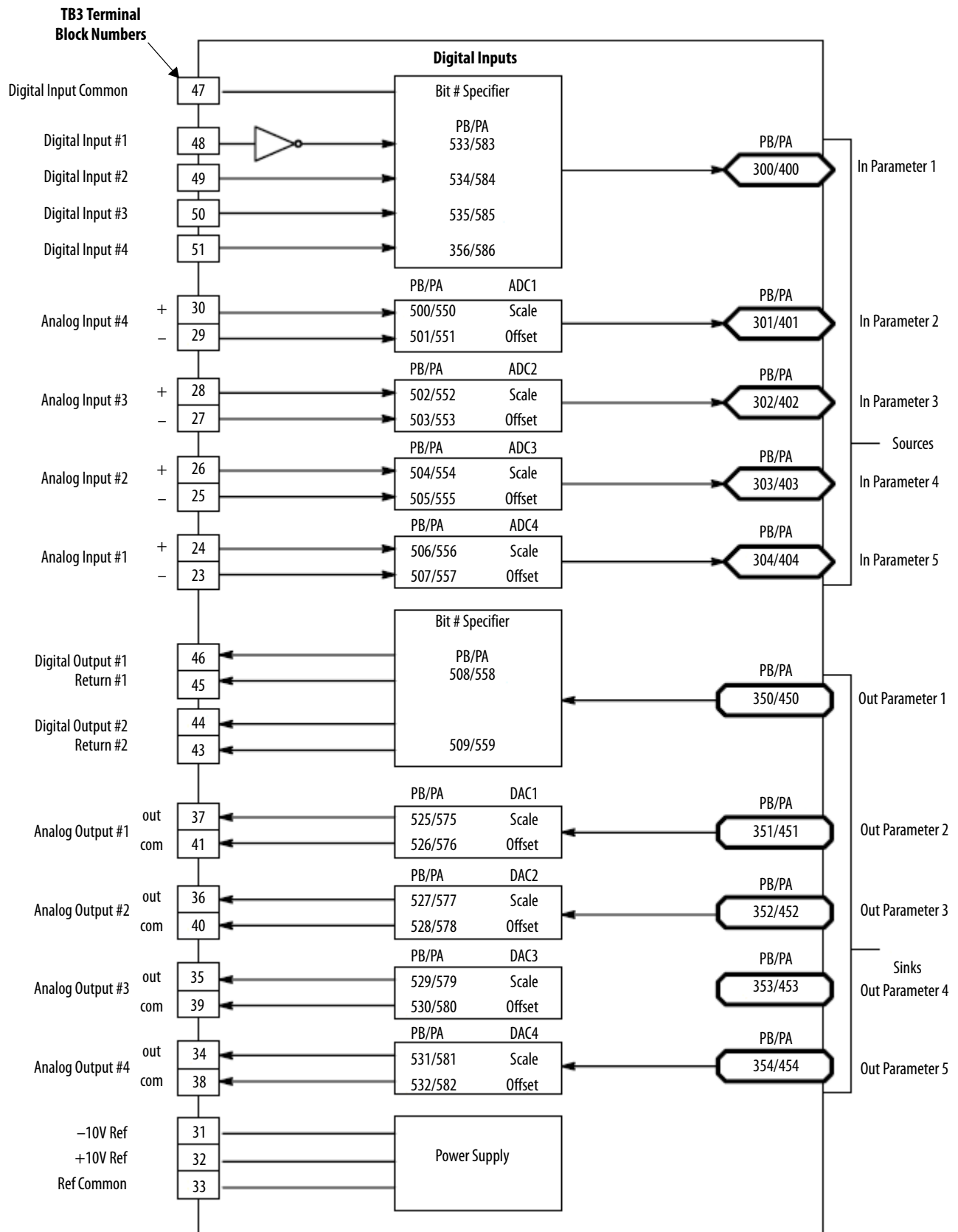


Figure 67 - 1395 Discrete Adapter Block Diagram



1395 Digital Reference Adapter Board

External wiring is connected to the terminal block at the bottom of the 1395 enclosure. Terminals 23 through 62 are reserved for wiring the Digital Reference Adapter Board to external I/O devices. See the 1395 Digital DC Drive, User Manual, publication [1395-UM003](#), or Bulletin 1395 Digital Reference Adapter Board Hardware/Software Reference Manual, publication [1395-RM001](#), for more details.

Figure 68 - 1395 Digital Reference Adapter Board Hardware Connection Diagram

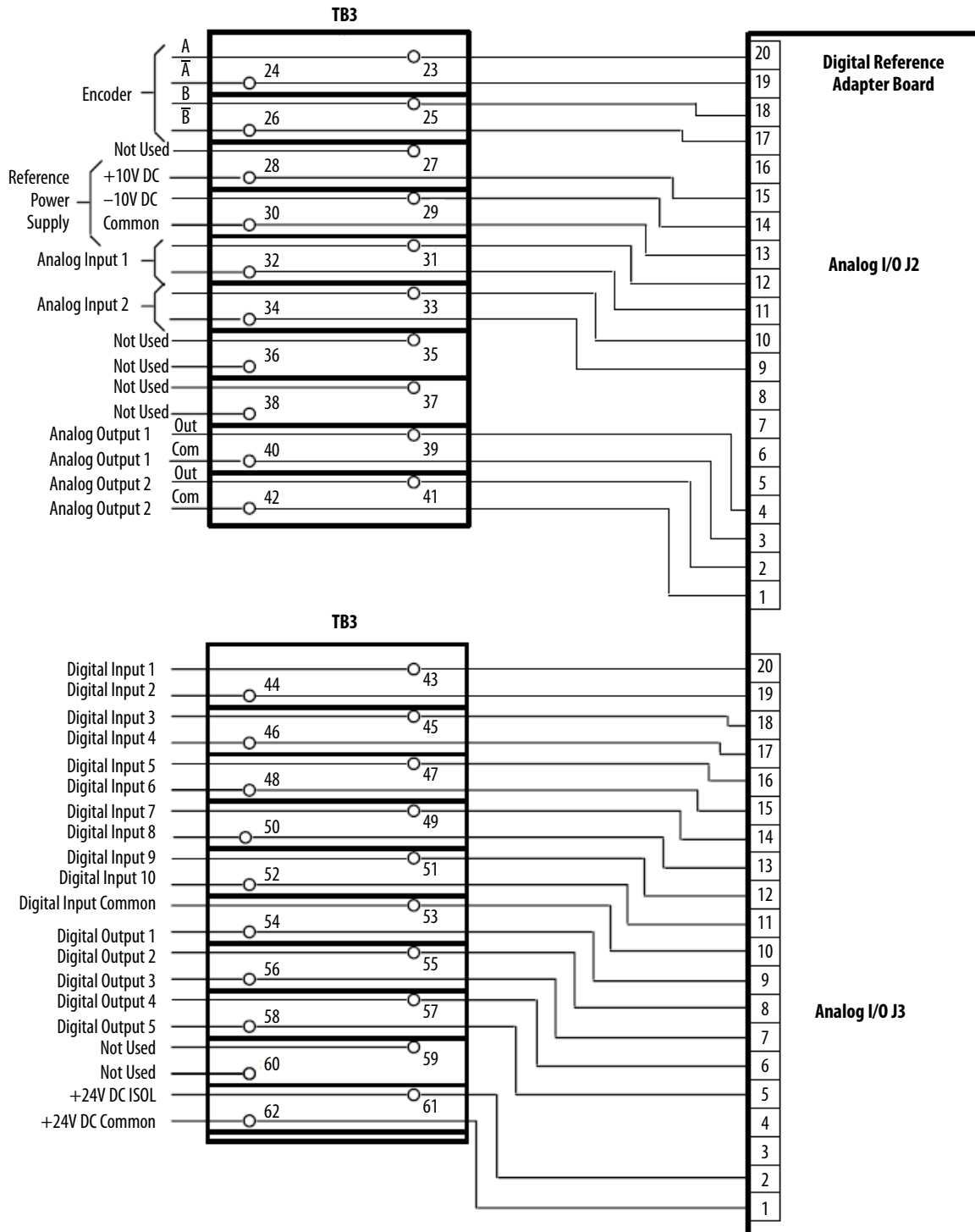
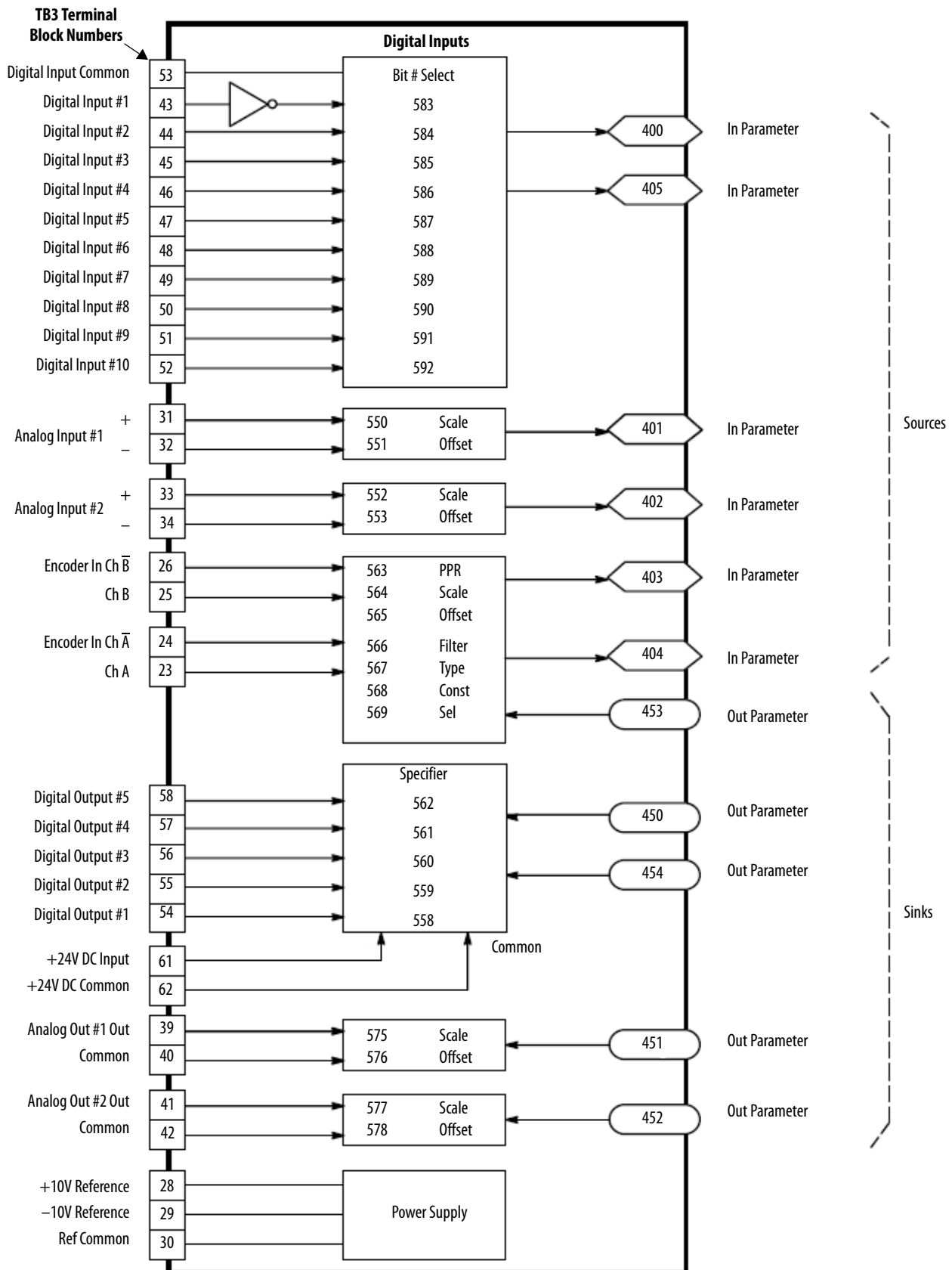


Figure 69 - 1395 Digital Reference Adapter Board Block Diagram



1395 Encoder Driver Interface Module

The Encoder Driver Interface module is a multi-purpose pulse amplifier primarily used for generating 15 mA, double-ended, sink and source output signals. These signals are acceptable as inputs to digital reference and/or digital feedbacks into opto-isolated circuits of Bulletin 1395, 1336 PLUS, 1336 FORCE and 1399 drives. The opto-isolated input signals are designed to guard against signal common loops and also to provide an improved signal to noise input circuit.

See the Encoder Driver Interface Module Installation Instructions, publication [1395-IN010](#), for more details.

1395 Digital Reference Adapter for RTP Applications

The Digital Reference Adapter board provides an interface between an external device and the Bulletin 1395 drive Main Control board. When used with the Reel-Tension-Paster (RTP) drive, the Digital Reference Adapter board allows the drive to be commanded by a digital reference input signal from a single channel encoder or frequency generator, whose shaft speed is equal to press speed. In this application, a magnetic pickup with a gear ranging from 128 to 140 teeth (dependent on printing diameter of the press) is used as the press speed sensor for the drive.

This board also allows the drive to be controlled using combinations of internal programmable relay logic at digital inputs 1...8, or through use of an analog device such as a dancer potentiometer. When the analog device is used for control, the dancer potentiometer provides position feedback sensing and controls the reel speed through the P/I regulator located on the Digital Reference Adapter board and the process trim regulator located on the Bulletin 1395 drive Main Control board.

See the Digital Reference Adapter for RTP Applications User Manual, publication [1395-IN030](#), for more details.

Please contact PrintGroupUSA@ra.rockwell.com via email for help with your migration strategy.

Bulletin 1397 Digital DC Drive

Most control connections on the 1397 drive are made at the Regulator board terminal strip which is located at the bottom of the drive as shown here.

See the Bulletin 1397 DC Drive Firmware 2.xx User Manual, publication [1397-UM000](#), for more details.

Figure 70 - 1397 Regulator Board Terminal Strip Location

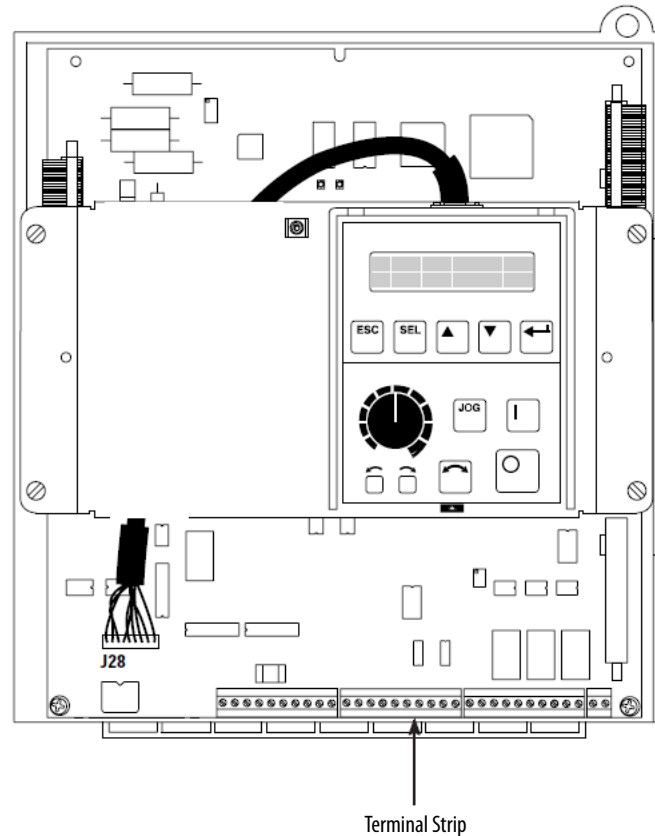
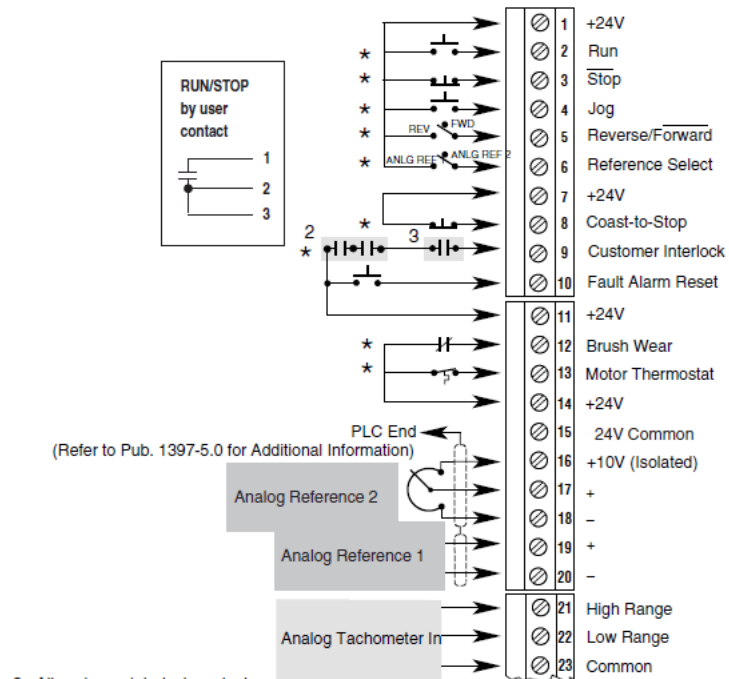


Figure 71 - 1397 Regulator Board Terminal Strip Inputs

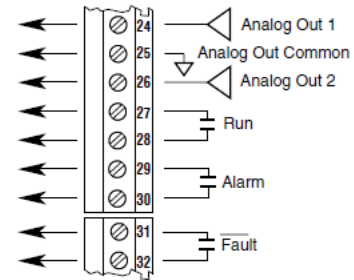


2> All customer interlock contacts must be closed for drive operation.

3> The circuit breaker is supplied with 200-300 HP regenerative drives. Note that if any other interlocks are required for your application, they must be connected in series with the circuit breaker contact to the customer interlock input.

* = Required for initial startup and operational checks. Voltage must be present at these points during operation.

Regulator Board Terminal Strip Inputs



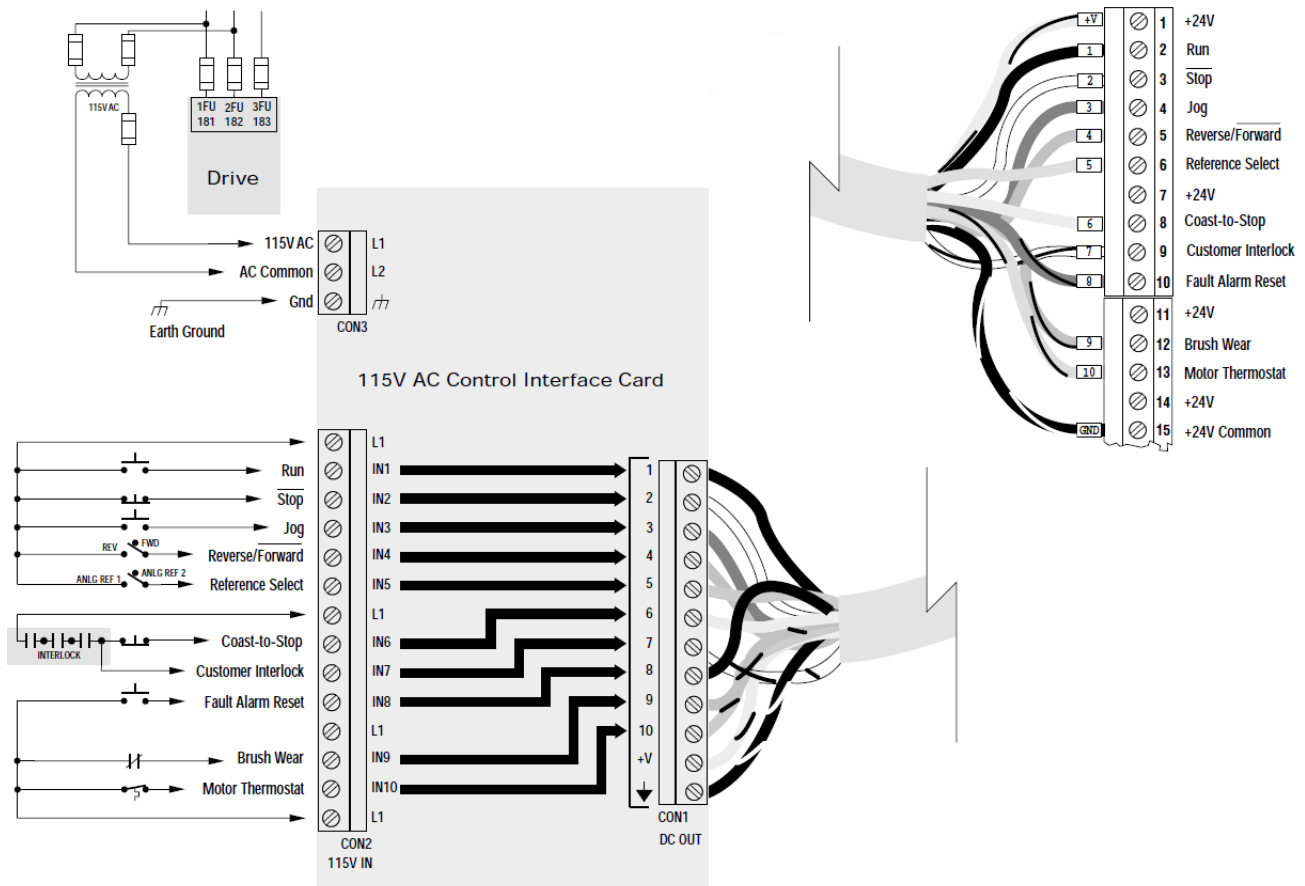
Regulator Board Terminal Strip Software Configurable Output Connections (Drive Contacts Shown In Unpowered State)

1397 - 115VAC Control Interface Card

The 115V AC Control Interface card is a remote mounted option that provides a means of interfacing signals and commands to the 1397 drive using 115V AC signals. A 115V AC power source must be supplied by the user for the card to operate.

See the 115V AC Control Interface Card Installation Instructions, publication [1397-IN007](#), for more details.

Figure 72 - 1397 - 115V AC Control Interface to Regulator Board Connections



1397 I/O Expansion Card

The I/O Expansion card is a drive mounted board that provides additional I/O signals, including five digital inputs, two digital outputs, 2 analog inputs, 2 analog outputs, one frequency input, and one frequency output.

See the 1397-L11 I/O Expansion Card Installation Instructions, publication [1397-IN008](#), for more details.

Figure 73 - I/O Expansion Card Terminal Blocks

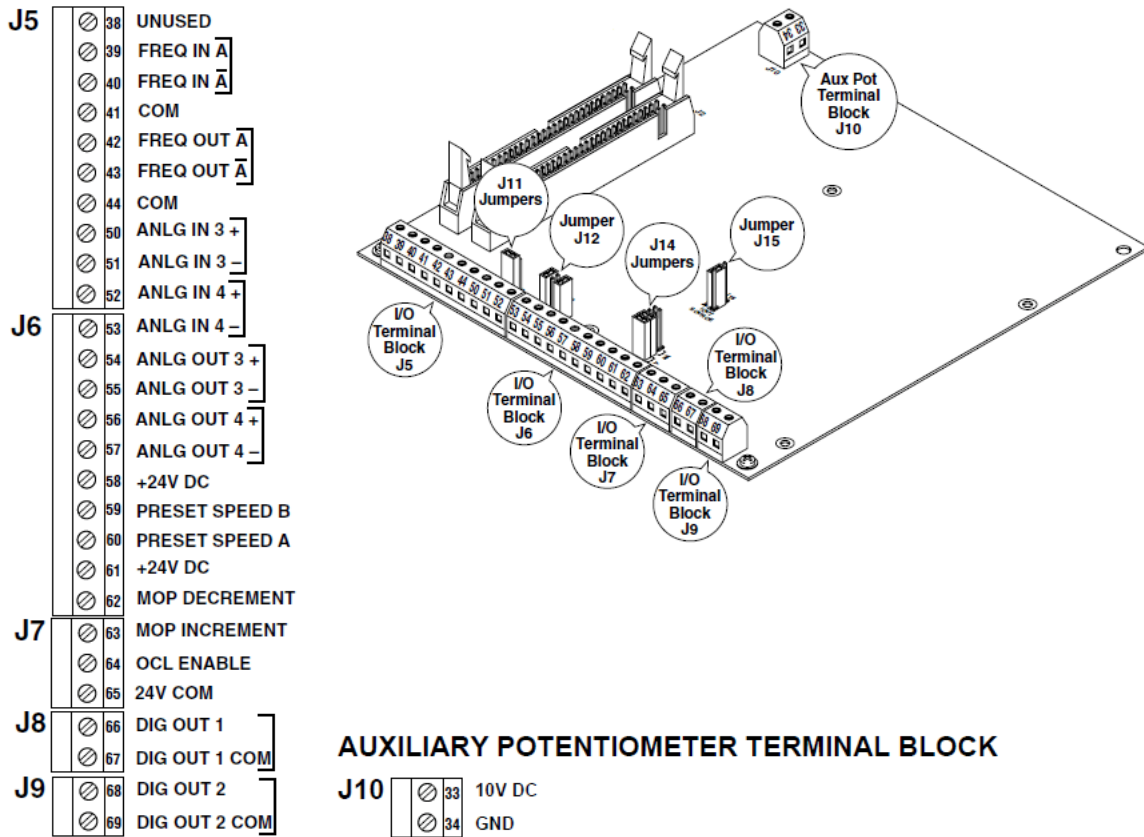


Figure 74 - I/O Expansion Card Digital Input Terminal Block

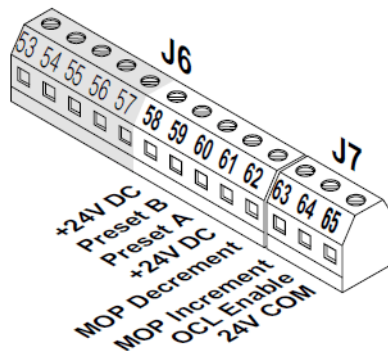


Figure 75 - I/O Expansion Card Digital Output Terminal Block

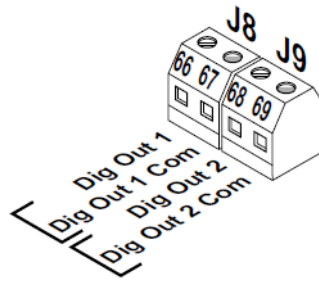


Figure 76 - I/O Expansion Card Analog Input Terminal Block

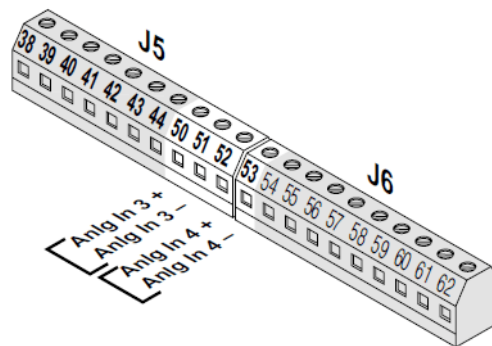


Figure 77 - I/O Expansion Card Analog Output Terminal Block

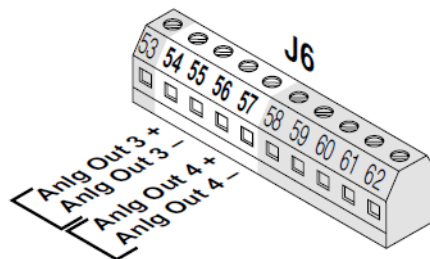


Figure 78 - I/O Expansion Card Frequency Input Terminal Block

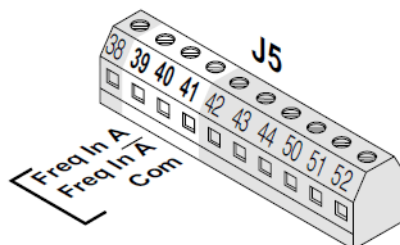
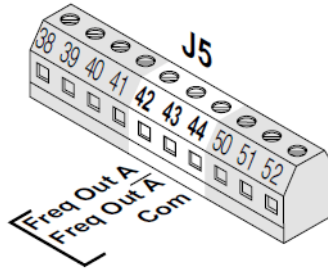


Figure 79 - I/O Expansion Card Frequency Output Terminal Block



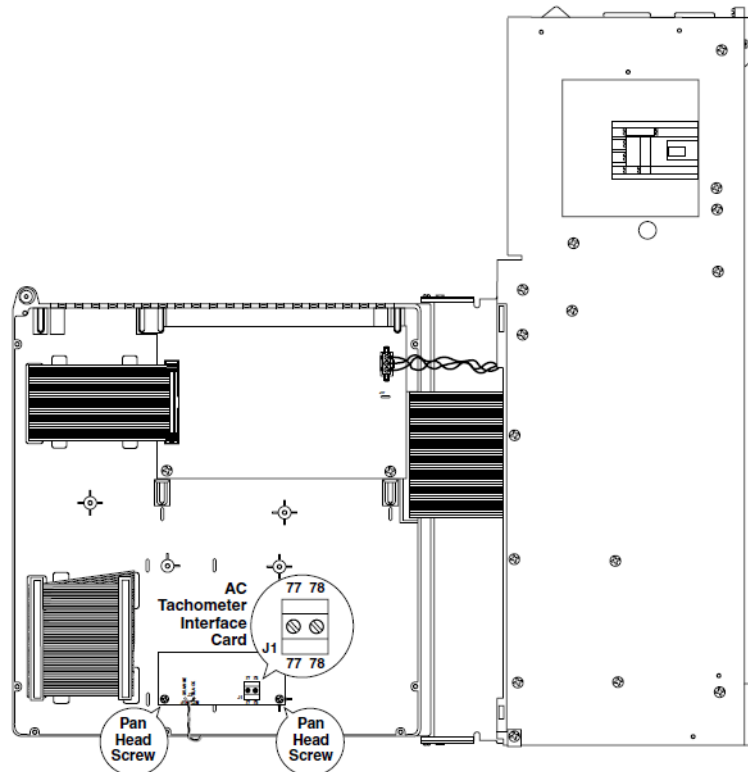
1397 AC Tachometer Interface Card

The AC Tachometer Interface card is designed for use with the following Reliance Electric tachometers; RE-045F, RE-045R, or RE-050.

IMPORTANT The card provides feedback signals for non-regenerative 1397 drives and cannot be used in conjunction with the Pulse Encoder Interface card.

For additional information on signal requirements, wire or cable requirements and parameter programming, see the Bulletin 1397 DC Drive Firmware 2.xx User Manual, publication [1397-UM000](#), and the AC Tachometer Interface Card Installation Instructions, publication [1397-IN011](#).

Figure 80 - AC Tachometer Interface Card Installation Location



1397 Pulse Encoder Interface Card

The Pulse Encoder Interface card is a drive mounted board that provides terminals and an interface to differential encoder feedback signals for both regenerative and non-regenerative 1397 drives.

For additional information on encoder signal requirements, wire recommendations, encoder parameters and related function blocks, see the Bulletin 1397 DC Drive Firmware 2.xx User Manual, publication [1397-UM000](#), and Pulse Encoder Interface Installation Instructions, publication [1397-IN002](#), for more details.

Terminal Blocks J5 and J6 are available for either regenerative or non-regenerative drive connection. Note: Only regenerative drives allow motor reversing. Regenerative drives require that quadrature pulse encoders be used.

Figure 81 - Non-Regenerative Drives — Non-Reversing Motor Applications

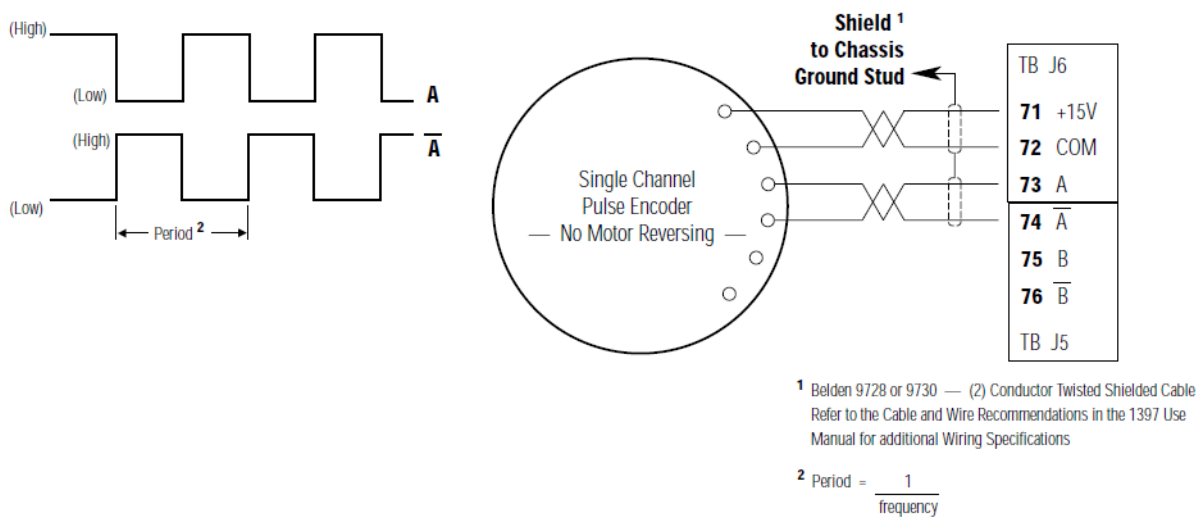
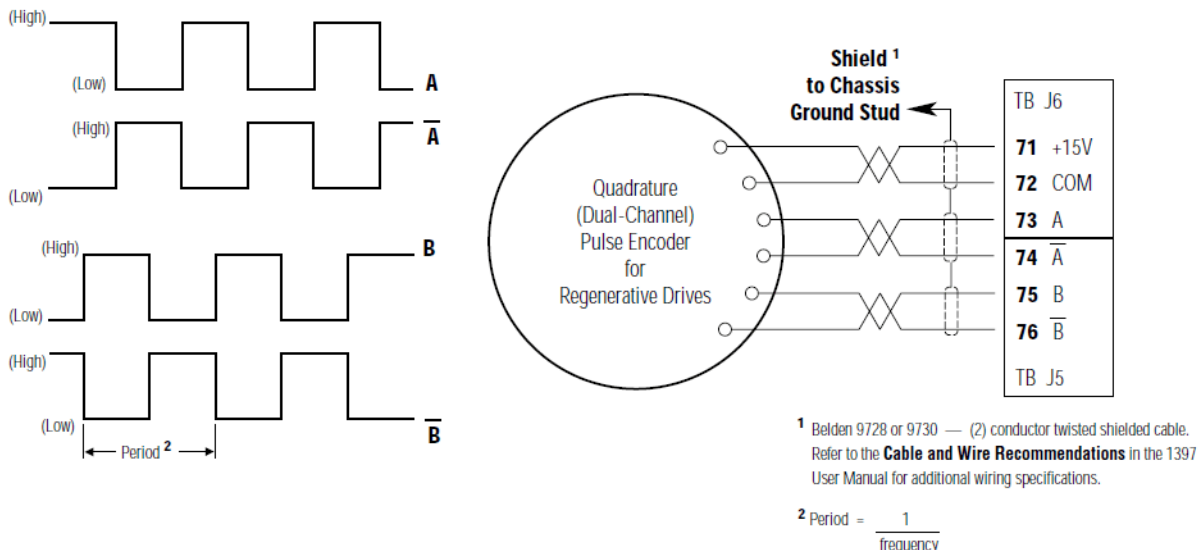


Figure 82 - Regenerative Drives — Reversing and Non-Regenerative Motor Applications



FlexPak 3000 DC Drive

Figure 83 - Regulator Board Terminal Strip Location

Shown with Standard Cover Removed

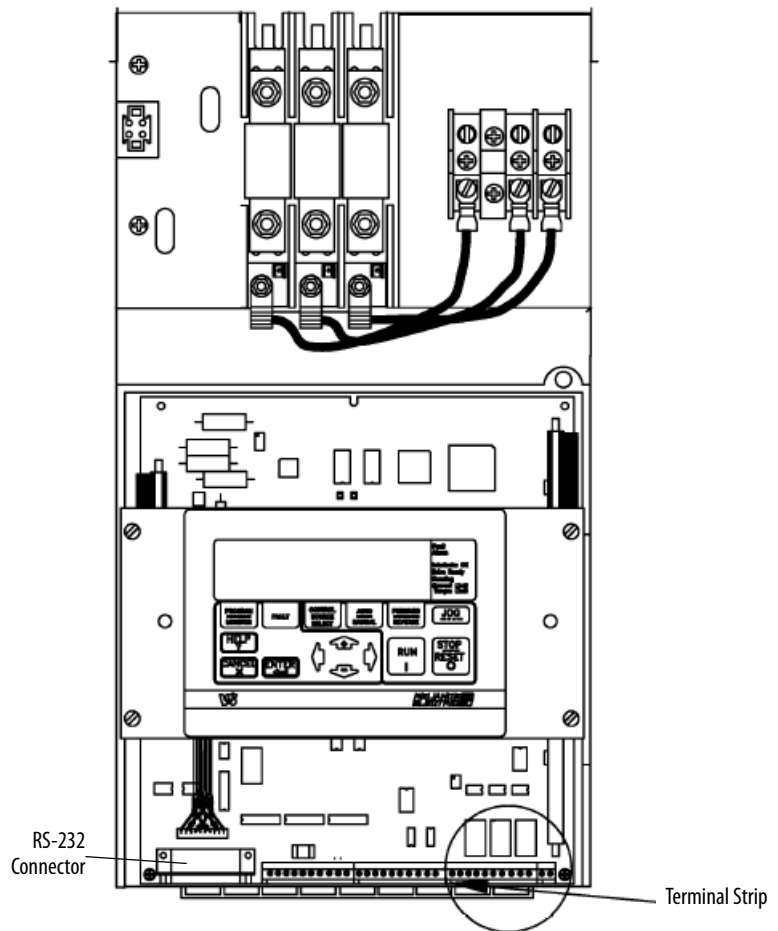
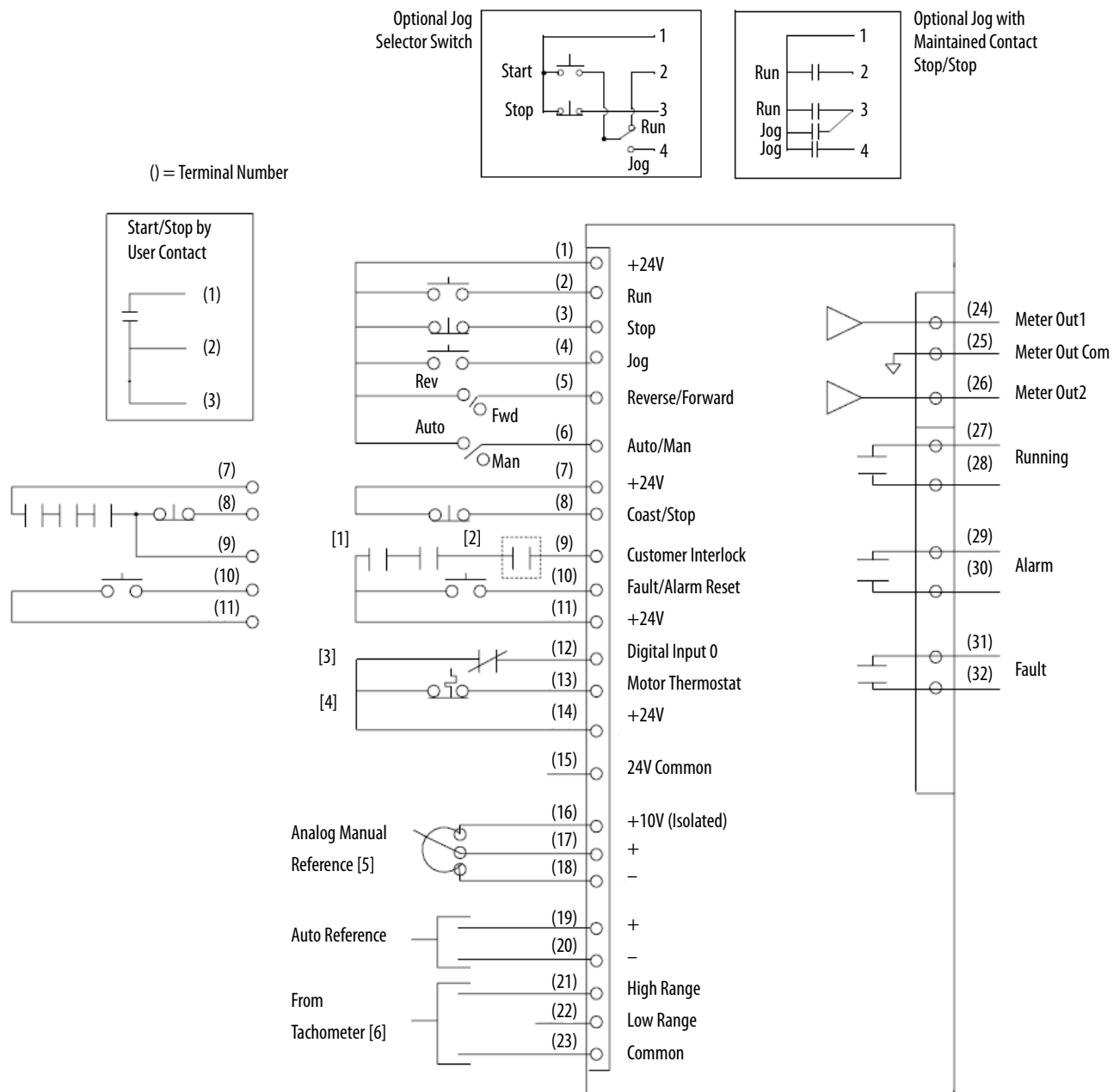


Figure 84 - Regulator Board Terminal Strip Wiring Diagram



- [1] All customer interlock contacts must be closed for the drive to operate. See [Table 12 on page 110](#) for details.
- [2] The inverting fault circuit breaker is supplied with 200 . . . 300 Hp regenerative drives. Note that if any other interlocks are required for your application, they must be connected in series with the inverting fault circuit breaker contact to the customer interlock input.
- [3] Potentiometer 5000 Ω minimum.
- [4] See parameters 428 and 490 in the Flexpak 3000 Digital DC Drive Software Reference Manual, publication [FP3-UM013](#).
- [5] The thermostat leads to the Regulator board terminal strip pins 13 and 14 should be routed through a separate conduit away from the motor armature, and field and blower motor power wiring. Regulator board damage can result from improper wiring practices.
- [6] AC or DC tachometer voltage polarity should be based on the polarity of the reference and the selection of the forward/reverse switch as show in this table.

Reference Polarity	Forward/Reverse	Tachometer Voltage Polarity
Positive	Forward	Positive
Positive	Reverse	Negative
Negative	Forward	Negative
Negative	Reverse	Positive

Table 12 - User Device Connections to the Regulator Board Terminal Strip

User Device	Regulator Board Terminal Number
Run	1 (+24V), 2
Stop	1 (+24V), 3
Jog	1 (+24V), 4
Reverse/Forward	1 (+24V), 5
Auto/Manual	1 (+24V), 6
Interlock	9, 11 (+24V)
Fault/Alarm Reset	10, 11 (+24V)
Digital Input 0	12, 11 (+24V)
Motor Thermostat	13, 11 (+24V)
Speed Reference Potentiometer <ul style="list-style-type: none"> • High Side (+10 ISOL) • Wiper (+ Man. Ref.) • Low Side (- Man. Ref.) 	16 17 18
Auto Reference <ul style="list-style-type: none"> • (+) • (-) 	19 20
Tachometer (Analog) ⁽¹⁾	
High Range ⁽²⁾	21
Low Range ⁽²⁾	22
Common ⁽²⁾	23
Meter output 1	24, 25 (Common)
Meter output 2	25 (Common), 26
Running (Indicator)	27, 28
Alarm (Indicator)	29, 30
No Fault (Indicator)	31, 32

(1) Analog tachometer must be rated between 18...200 V/1000 RPM. The output voltage must not exceed 250V for a DC tachometer or 275 RMS for AC tachometers when the motor is rotating at the value set for the TOP SPEED parameter. To calculate the output voltage at top speed: Tachometer Voltage at Top Speed = (Top Speed / 1000) x (Analog Tach Voltage / 1000). See the User Manual for information on jumpers J14 and J11.

(2) When the maximum tachometer voltage at top speed is 62VDC, use terminals 22 and 23 to connect the analog tachometer. When the maximum tachometer voltage at top speed is 250VDC, use terminals 21 and 23 to connect the analog tachometer.

Flexpak 3000 115V AC Control Option Board

See the Installing the 115V AC Control Option Board Installation Instructions, publication [GY3000-IN004](#), for more details.

Figure 85 - 115V AC Control Option Board Inputs and Outputs

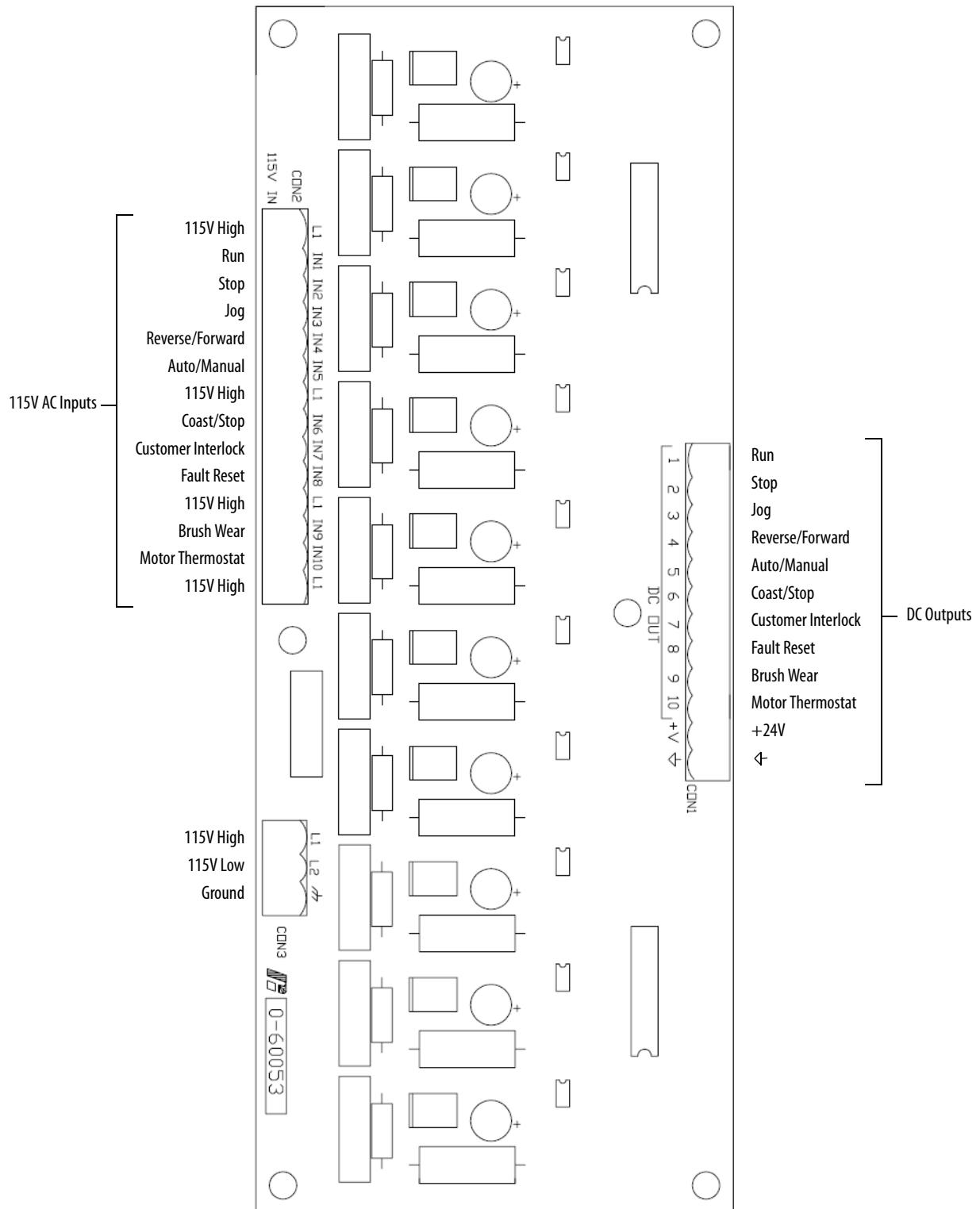


Table 13 - Control Option Board Wiring to a FlexPak 3000 Drive

Control Device	Control Option Board		FlexPak 3000 Regulator Board Terminal
	AC Input Terminal	DC Output Terminal	
Run	2 (IN1)	1	2
Stop	3 (IN2)	2	3
Jog	4 (IN3)	3	4
Reverse/Forward	5 (IN4)	4	5
Auto/Manual	6 (IN5)	5	6
Coast/Stop	8 (IN6)	6	8
Interlock	9 (IN7)	7	9
Fault/Alarm Reset	10 (IN8)	8	10
Brush Wear	12 (IN9)	9	12
Motor Thermostat	13 (IN10)	10	13
Note: 115V High (L1) is at terminals 1, 7, 11, and 14.		11 (+V)	1, 7, 11, or 14
		12 (Gnd)	15

FlexPak 3000 I/O Expansion Kit

This kit provides additional input/output capabilities for FlexPak 3000 drives, including five digital inputs, two digital outputs, two analog inputs, two analog outputs, one frequency input, and one frequency output. See the FlexPak 3000 Drive I/O Expansion Kit Installation Instructions, publication [FP3-IN007](#), for more details.

Figure 86 - I/O Expansion Kit

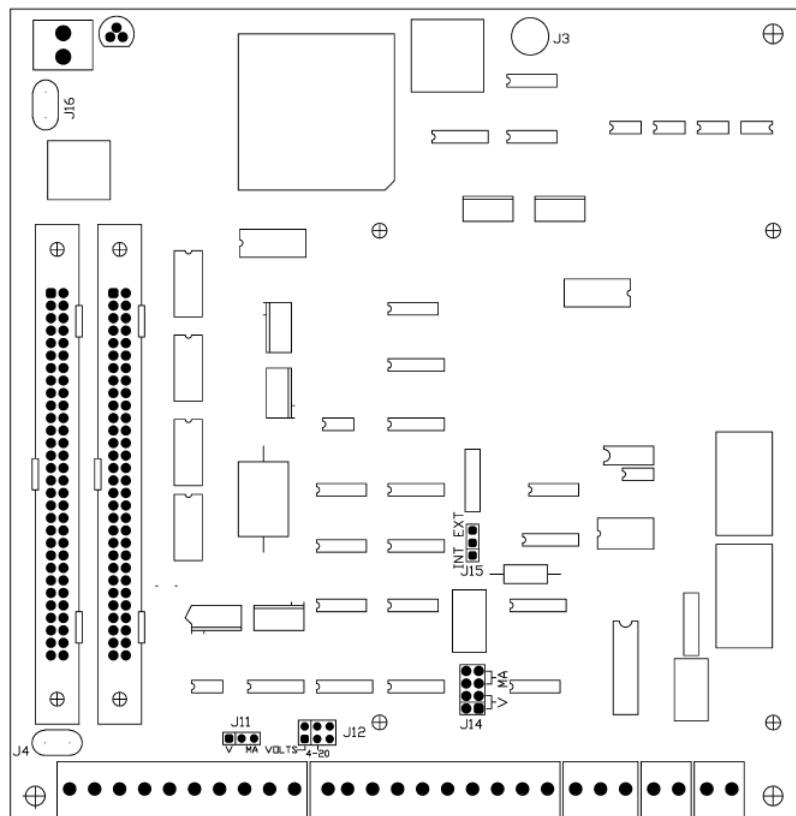


Figure 87 - I/O Expansion Kit Jumper Settings

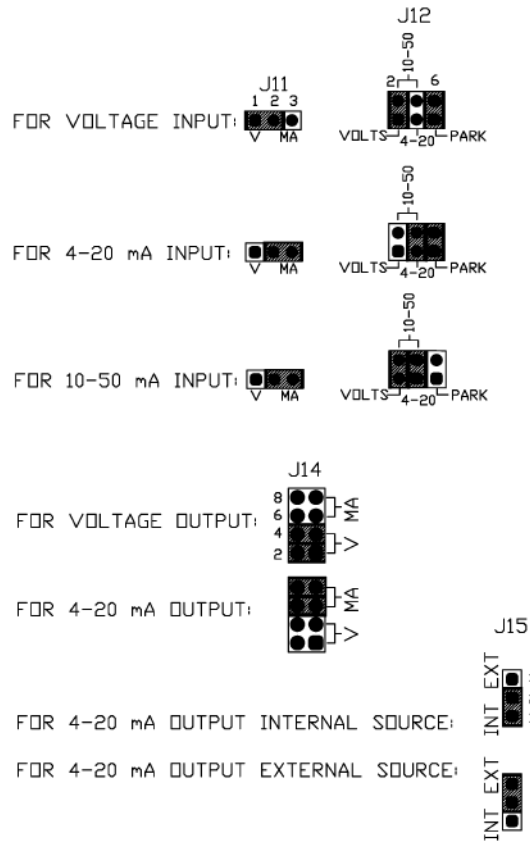
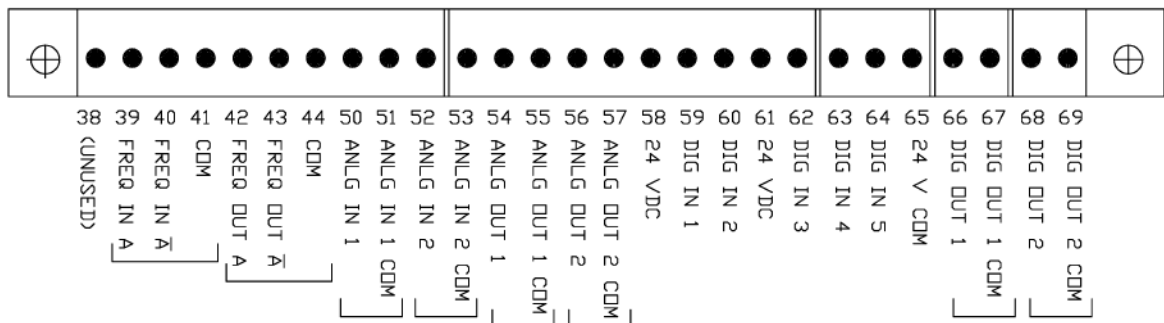


Figure 88 - I/O Expansion Kit Terminal Block Designations



FlexPak 3000 AC Tachometer Interface Kit

See the FlexPak 3000 Drive AC Tachometer Interface Kit Installation Instructions, publication [FP3-IN003](#), for more details.

Figure 89 - FlexPak 3000 Regulator Board Jumper Locations

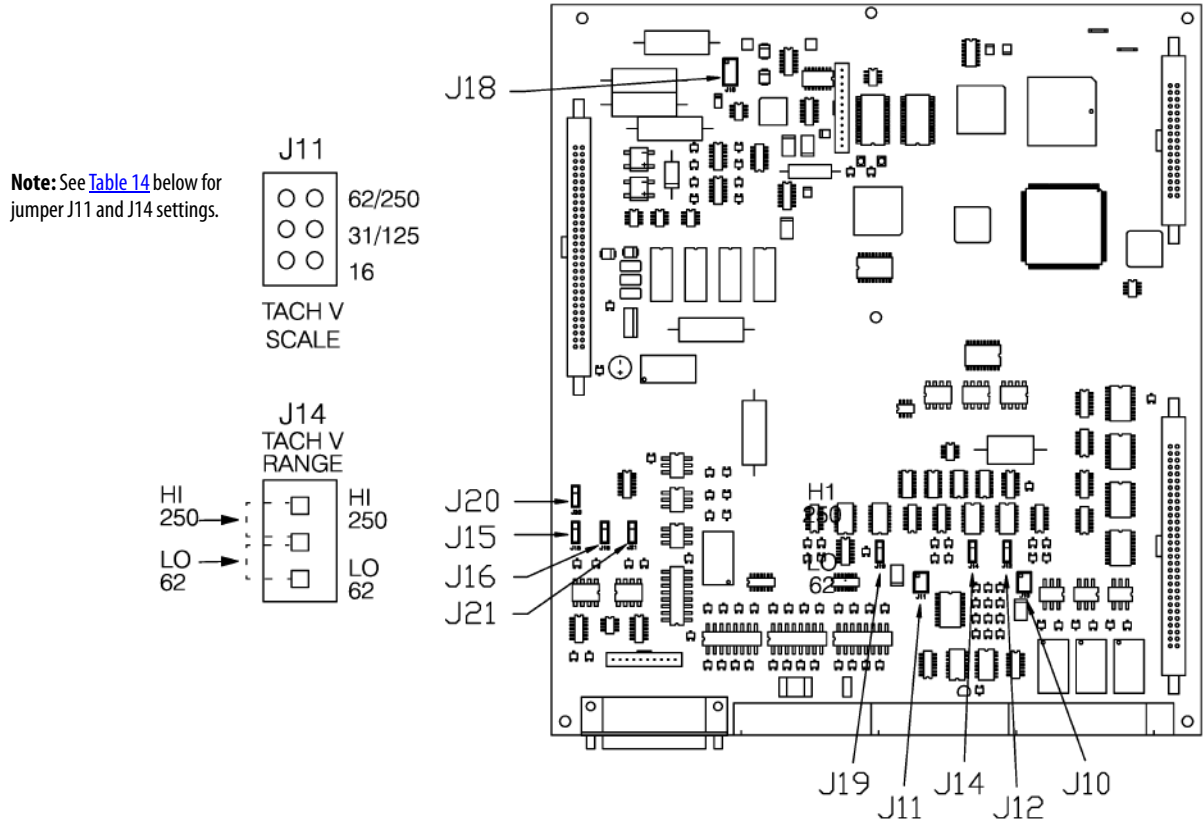
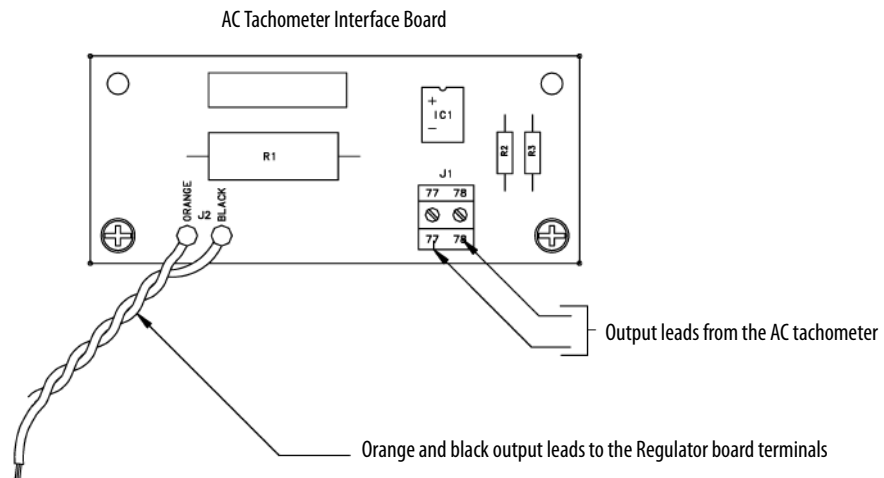


Table 14 - Regulator Board Jumper Settings

Calculated DC Voltage from Interface Board	Jumper Settings ⁽¹⁾	
	J11	J14
Less than or equal to 16V	16	LO 62
17...31 Volts	31 / 125	LO 62
32...62 Volts	62 / 250	LO 62
63...125 Volts	31 / 125	HI 250
126...250 Volts	62 / 250	HI 250

(1) If you set the AC Tachometer Interface board parameters while performing the quick start procedure described in the FlexPak 3000 Drive User Manual, you will be prompted with these jumper settings.

Figure 90 - AC Tachometer Interface Kit Terminal Block Locations



The orange and black wires from the AC Tachometer Interface board are connected to the terminals on the drive’s Regulator board. See [Figure 83](#) on page [108](#) for the Regulator board terminal strip locations and [Figure 84](#) on page [109](#) for terminal strip descriptions.

- The black wire from the AC Tachometer Interface board connects to terminal 23 (common) on the drive’s Regulator board.
- The orange wire from the AC Tachometer Interface board connects to the appropriate terminal on the drive’s Regulator board, according to [Table 15](#).

Table 15 - Regulator Board to AC Tachometer Interface Board Wiring

Calculated DC Voltage from Interface Board	Orange Wire Terminal Connection
Less than or equal to 16V	22 (LO range)
17...31 Volts	22 (LO range)
32...62 Volts	22 (LO range)
63...125 Volts	21 (HI range)
126...250 Volts	21 (HI range)

FlexPak 3000 Pulse Encoder Interface Kit

See the FlexPak 3000 Pulse Encoder Interface Kit Installation Instructions, publication [FP3-IN008](#), for details.



ATTENTION: Do not route pulse encoder wiring with AC and DC power or logic control wiring in the same conduit. This may cause interference with drive operation. Failure to observe this precaution could result in damage to or destructions of the equipment.



ATTENTION: Do not ground any pulse encoder wiring connection. Failure to observe this precaution could result in damage to or destructions of the equipment.

Figure 91 - Pulse Encoder Interface Board Terminal Block Location

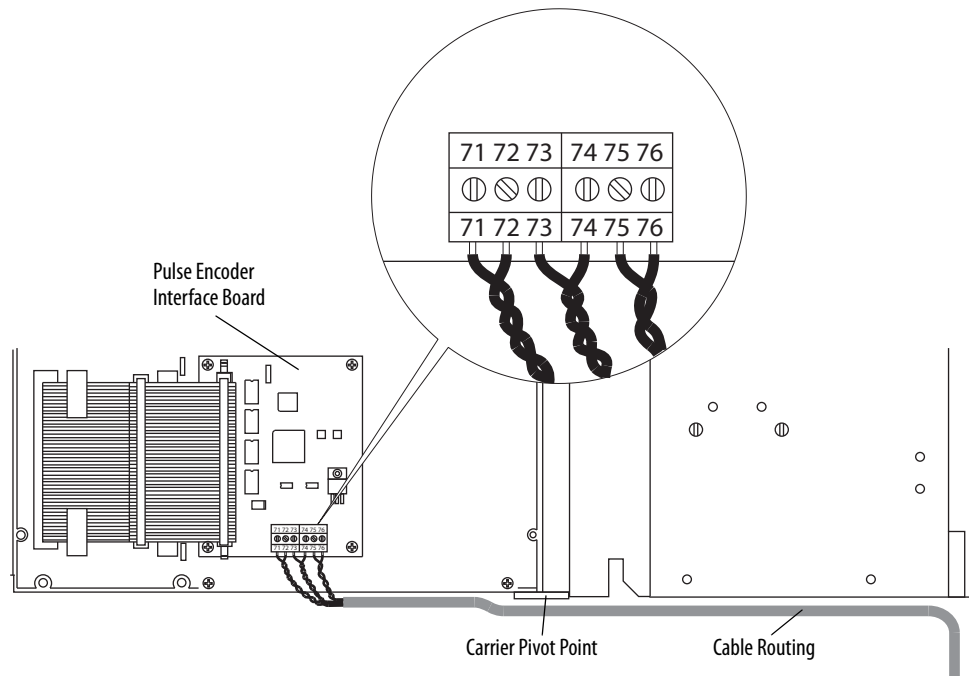


Table 16 - Pulse Encoder Interface Board Wiring

Twisted Pair Number	Signal	Terminal Number
1	+15V DC	71
	15V DC Common	72
2	A	73
	A Not	74
3	B	75
	B Not	76

PowerFlex DC Drive

PowerFlex DC I/O Signal and Control Wiring

Eight (8) digital inputs, four (4) digital outputs, three (3) analog inputs, and two (2) analog outputs are available on the standard I/O terminal blocks provided with the drive. One digital input (1-8) must be configured for “Enable”.

Additional digital and analog I/O is available when using the optional I/O Expansion circuit board. Refer to Appendix F - “Optional Analog and Digital I/O Expansion Circuit Board”, in the PowerFlex Digital DC Drive User Manual, publication [20P-UM001](#), for more information. Also, you can use the optional 115V AC Converter circuit board to convert 115V AC digital input signals to 24V DC digital inputs signals to interface with the digital inputs on the standard I/O terminal blocks. Refer to Appendix G - “Optional 115V AC to 24V DC I/O Converter Circuit Board” in the PowerFlex Digital DC Drive User Manual, publication [20P-UM001](#), for more information. All I/O terminal blocks are located on the control board.

Figure 92 - I/O Terminal Block Locations

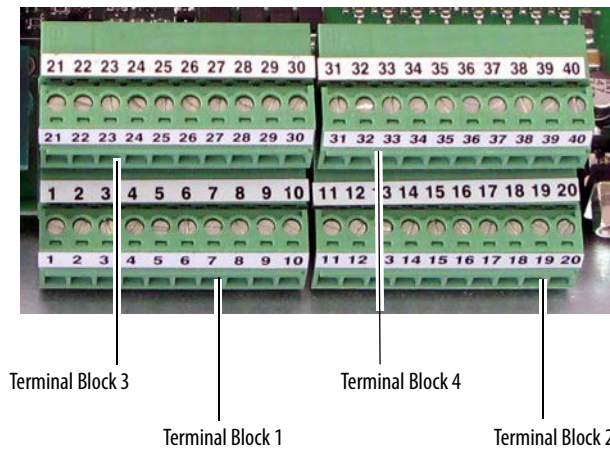
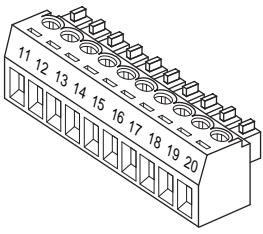


Table 17 - I/O Terminal Block 1 Designations

No.	Signal	Description	Factory Default	Related Parameter	
1	Analog Input 1 (+)	Isolated ⁽¹⁾ , bipolar, differential, $\pm 10V / 0-20mA$, or $4-20mA$. Important: 0-20mA or 4-20mA operation requires that switch S9, S10, and S11 on the Control board be in the “Off” position. Drive damage may occur if the switch is not in the correct position based on the type of input signal. Refer to “DIP Switch and Jumper Settings” in the PowerFlex Digital DC Drive User Manual, publication 20P-UM001 . Max $\pm 10V$, Max 0.25mA.	1 “Speed Ref A”	70 [Anlg In1 Sel]	
2	Analog Input 1 (-)		0 “Off”	75 [Anlg In2 Sel]	
3	Analog Input 2 (+)		0 “Off”	80 [Anlg In3 Sel]	
4	Analog Input 2 (-)				
5	Analog Input 3 (+)				
6	Analog Input 3 (-)				
7	+10V Pot Reference		2-5k ohm load. Max $\pm 10V$, Max 10mA.	–	–
8	–10V Pot Reference				
9	Pot Common		For (+) and (-) 10V pot references.	–	–
10	PE ground		PE ground to drive chassis.	–	–

(1) Differential Isolation - External source must be maintained at less than 160V with respect to PE. Input provides high common mode immunity.

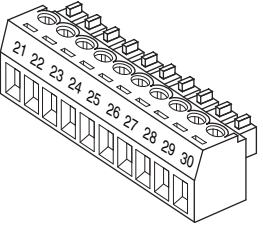
Table 18 - I/O Terminal Block 2 Designations



No.	Signal	Description	Factory Default	Related Parameter
11	Internal 0V		–	–
12	Digital Input 1	Max Volt. +30V, Max Cur. 15V/3.2mA, 24V/5mA, and 30V/6.4mA.	2 “Stop/CF”	133 [Digital In1 Sel]
13	Digital Input 2		3 “Start”	134 [Digital In2 Sel]
14	Digital Input 3		11 “Jog”	135 [Digital In3 Sel]
15	Digital Input 4		1 “Enable” ⁽³⁾	136 [Digital In4 Sel]
16	Digital Input Common ⁽¹⁾		–	–
17	Not Used		–	–
18	24V Supply Common	Common for the internal power supply.	–	–
19	+24V DC Supply	Drive supplied control input power. Max. +20-30V, 200mA ⁽²⁾	–	–
20	PE ground	PE ground to drive chassis.	–	–

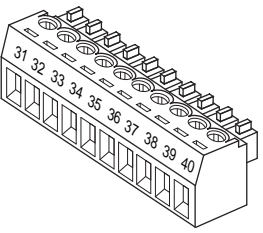
- (1) When using the internal +24V DC supply (terminal 19) for digital inputs 1-4, you must connect the digital input common (terminal 16) to the +24V supply common (terminal 18).
- (2) The total current draw is the sum of encoder power, digital outputs and any other loads connected to terminal 19.
- (3) A digital input (1-8) must be configured for “Enable”.

Table 19 - I/O Terminal Block 3 Designations



No.	Signal	Description	Factory Default	Related Parameter
21	Analog Output 1 (+)	Max. ±10V, Max. 5 mA.	12 “Motor Speed”	66 [Anlg Out1 Sel]
22	Analog Output 1 (–)			
23	Analog Output 2 (+)		13 “Motor Curr”	67 [Anlg Out2 Sel]
24	Analog Output 2 (–)			
25	Digital Output Common		–	–
26	Digital Output 1	Max. +30V, Max 50mA	5 “Ready”	145 [Digital Out1 Sel]
27	Digital Output 2		9 “Fault”	146 [Digital Out2 Sel]
28	Digital Output 3		2 “Spd Thresh”	147 [Digital Out3 Sel]
29	Digital Output 4		4 “CurrentLimit”	148 [Digital Out4 Sel]
30	+24VDC	Drive supplied power for Digital Outputs. Max. –80V, Max. 80mA.	–	–

Table 20 - I/O Terminal Block 4 Designations



No.	Signal	Description	Factory Default	Related Parameter
31	Digital Input 5	Max Volt. +30V, Max Cur. 15V/3.2mA, 24V/5mA, and 30V/6.4mA.	17 “Speed Sel 1”	137 [Digital In5 Sel]
32	Digital Input 6		18 “Speed Sel 2”	138 [Digital In6 Sel]
33	Digital Input 7		19 “Speed Sel 3”	139 [Digital In7 Sel]
34	Digital Input 8		31 “Contactor”	140 [Digital In8 Sel]
35	Digital Input Common	Important: When using the internal +24V DC supply (terminal 19) for digital inputs 5-8, you must connect the digital input common (terminal 35) to the +24V supply common (terminal 18).	–	–
36-40	Not Used		–	–

Table 21 - Recommended Signal Wire Size for Analog I/O and Digital I/O

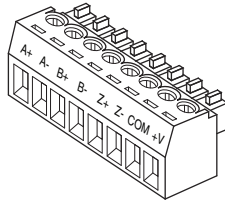
Signal Type	Terminal Block (Terminals)	Wire Size and Type ⁽¹⁾			Tightening Torque N•m (lb•in)
		Flexible (mm ²)	Multi-core (mm ²)	AWG	
Analog and Digital I/O	TB1...4 (1...40)	0.140...1.500	0.140...1.500	26...16	0.4 (3.5)

(1) See "Cable and Wiring Recommendations" in the PowerFlex Digital DC Drive User Manual, publication [20P-UM001](#), for cable spacing information.

PowerFlex DC Digital Encoder Terminal Block

The encoder connection cables should always be connected directly to the terminals on the encoder terminal block. The encoder cable must be made up of twisted pairs with the shield connected to the shield ground on the drive side. Do not connect the shield to ground on the motor side. In some cases (i.e., cable lengths that exceed 100 meters), it may be necessary to ground the shield of each twisted pair on the power supply. Refer to Appendix A of the PowerFlex Digital DC Drive User Manual, publication [20P-UM001](#), for Digital Encoder specifications.

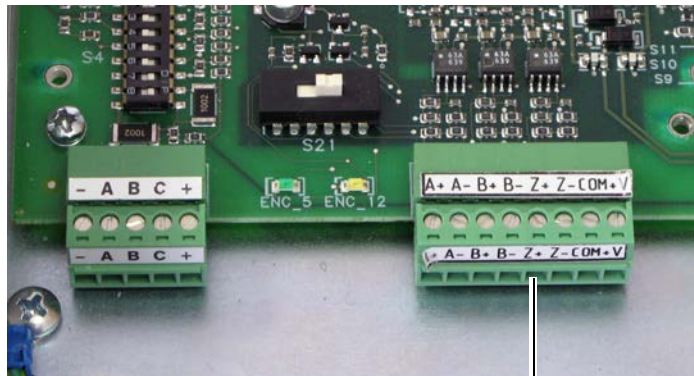
Table 22 - Digital Encoder Terminal Designations

	No.	Description	
	A+	Encoder A	Single channel or quadrature A input
	A-	Encoder A (NOT)	
	B+	Encoder B	Dual channel quadrature B input
	B-	Encoder B (NOT)	
	Z+	Encoder Z	Pulse, marker or registration input ⁽²⁾
	Z-	Encoder Z (NOT)	
	COM	+5/12-15V ⁽¹⁾ DC Return	Internal power common
	+V	+5/12-15V ⁽¹⁾ DC Power	Internal power source 200 mA

(1) Selectable via switch S21 on the Control board. Refer to "DIP Switch and Jumper Settings" in the PowerFlex Digital DC Drive User Manual, publication [20P-UM001](#), for more information.

(2) Selectable via switch S20 on the Control board. Refer to "DIP Switch and Jumper Settings" in the PowerFlex Digital DC Drive User Manual, publication [20P-UM001](#), for more information.

Figure 93 - Digital Encoder Terminal Block Location



Digital Encoder terminal block

Table 23 - Sample Encoder Wiring

I/O	Connection Example
<p>Encoder Power – ⁽¹⁾ Internal Drive Power Internal (drive) +5/12-15V DC, 200 mA</p>	
<p>Encoder Power –External Power Source</p>	
<p>Encoder Signal –Single-Ended, Dual Channel</p>	
<p>Encoder Signal –Differential, Dual Channel</p>	

(1) Shield connection is on the drive Control EMI Shield. See Digital Encoder Terminal Block Location on page 120.

PowerFlex DC DC Analog Tachometer Terminal Block



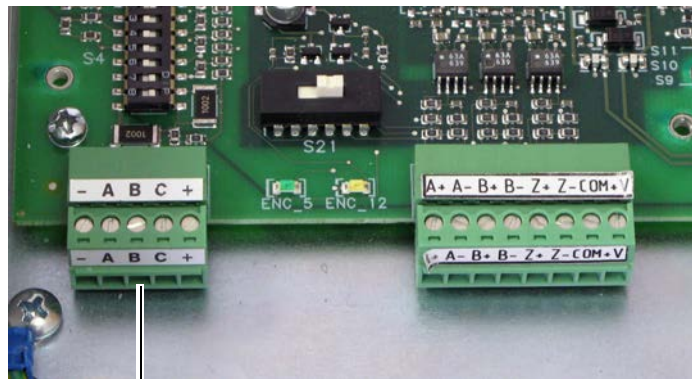
ATTENTION: The Drive can overspeed if DIP switch S4 is set incorrectly, or the tachometer is wired incorrectly. Failure to observe this precaution could result in damage to, or destruction of, the equipment.

Table 24 - DC Analog Tachometer Terminal Designations

	No.	Signal	Description
	-	Negative input	-
	A	(Not Used)	
	B		
	C		
	+	Positive input Feedback polarity is determined during the start up routine.	22.7 / 45.4 / 90.7 / 181.6 / 302.9V ⁽¹⁾ max voltage 8 mA max. current

(1) Maximum voltage depends on the configuration of DIP switch S4. Refer to the PowerFlex® Digital DC Drive User Manual, publication [20P-UM001](#) for information on jumper settings.

Figure 94 - Analog Tachometer Terminal Block Location



Analog Tachometer terminal block

Table 25 - Recommended Signal Wire Size for DC Analog Tachometer

Signal Type	Terminal Block (Terminals)	Wire Type and Size ⁽¹⁾			Tightening Torque N•m (lb•in)
		Flexible (mm ²)	multi-core (mm ²)	AWG	
DC Analog Tach	M3 (+ and -)	0.140...1.500	0.140...1.500	26...16	0.4 (3.5)

(1) See "Cable and Wiring Recommendations in the PowerFlex Digital DC Drive User Manual, publication [20P-UM001](#).

PowerFlex DC Resolver Feedback Module

The resolver feedback module (catalog number 20P-RES-A0), which provides a drive interface to a selection of compatible resolvers, must be ordered and purchased separately from the drive. The resolver option module includes the PowerFlex DC Drive Resolver Feedback Module Installation Instructions, publication 20P-IN071, which provides installation and wiring information. See "Resolver Type Selection" in the PowerFlex Digital DC Drive User Manual, publication [20P-UM001](#), for more information on compatible resolvers.

Resolver Type Selection

The following table provides a description and related attributes for the resolver types compatible with the PowerFlex DC drive and resolver feedback module.

Where possible, specific compatible resolver models have been identified.

Additional options are available for this parameter when a resolver with matching attributes is used (identified by the option “Resolver xx”).

Table 26 - Resolver Type Attributes

Par 423 [Reslvr Type Sel] Option	Resolver Catalog Numbers (Manufacturer) ⁽¹⁾	Par 424 [Reslvr Spd Ratio]	Carrier Frequency	Input Voltage	Transformer Ratio	Feedback Amp Gain	Power Amp Voltage
1 “2014x1/AMCI”	800123-R, -1R, -2R (Rel) TS-2014N181E32 (Tam) TS-2087N1E9 (Tam) TS-2087N11E9 (Tam) R11X-C10/7 (Adv)	x1	2381	26	0.4538	0.5	45
2 “T2014x2/2087”	800123-S, -1S, -2S (Rel) TS-2014N182E32 (Tam) TS-2087N12E9 (Tam) TS-2087N2E9 (Tam)	x2	2381	26	0.4538	0.5	45
3 “T2014x5/2087”	800123-T, 1T, 2T (Rel) TS-2014N185E32 (Tam) TS-2087N5E9 (Tam)	x5	2381	26	0.4538	0.5	45
4 “Resolver 04”	–	x2	4000	8	0.25	0.92	14
5 “Resolver 05”	–	x2	9300	22	0.5	0.5	45
6 “Resolver 06”	–	x1	4000	5	0.5	0.92	14
7 “Resolver 07”	–	x1	7000	4.25	0.4706	0.92	14
8 “Resolver 08”	–	x1	2500	12	0.5	0.5	45
9 “Resolver 09”	–	x2	4000	8	0.25	0.92	14
10 “Resolver 10”	–	x2	9300	15.5	0.5013	0.5	45
11 “Resolver 11”	–	x2	2500	7	1.7	0.5	45
12 “Resolver 12”	–	x2	9300	22	0.5	0.5	45
13 “Resolver 13”	–	x1	2000	6.36	0.5	0.92	14
14 “Resolver 14”	–	x1	6500	8	0.5	0.5	14
15 “Resolver 15”	–	x1	6500	8	0.5	0.5	14

(1) Abbreviations in this column indicate the following resolver manufacturers: Adv = Advanced Micro Controls, Inc. (AMCI), Rel = Reliance (-x = foot mounted, -1x = foot mounted, double shaft, -2x = flange mounted), Tam = Tamagawa.

PowerFlex DC Analog and Digital I/O Expansion Circuit Board

The I/O expansion board is a drive mounted option module that provides these additional I/O signals.

- Four Digital Inputs
- Four Digital Outputs
- Two Analog Outputs

Table 27 - Recommended Signal Wire Size

Wire Type and Size			Tightening Torque N-m (lb-in)
Flexible (mm ²)	multi-core (mm ²)	AWG	
0.14...1.5	0.14...1.5	28...16	0.4 (3.5)

A 75 x 2.5 x 0.4 mm (3.0 x 0.1 x 0.02 in.) flathead screwdriver is recommended for connecting wire to the terminal block inputs. Strip the ends of the cables to a length of 6.5 mm (0.26 in.).

IMPORTANT To improve the noise immunity it is recommended that you connect the common of the outputs (terminals 2, 4, 5 and 15 of the I/O Expansion board) with the ground (terminal 10 or 20) on the standard I/O terminal blocks on the Control board. If this is not possible, these terminals must be grounded by means of a 0.1 mf/250V capacitor.

Table 28 - I/O Expansion Board Terminal Block 1 Designations

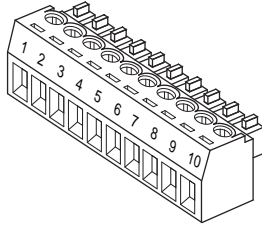
	No.	Signal	Description
	1	Analog Output 3 (+)	±10V, 5 mA maximum
	2	Analog Output 3 (-)	
	3	Analog Output 4 (+)	±10V, 5 mA maximum
	4	Analog Output 4 (-)	
	5	Digital Output Common	Max volt. +30V, max cur. 50 mA
	6	Digital Output 5 (+)	
	7	Digital Output 6 (+)	
	8	Digital Output 7 (+)	
	9	Digital Output 8 (+)	
	10	+24VDC	Drive supplied power for Digital Outputs. Max voltage +30V, max. current 80 mA.

Table 29 - I/O Expansion Board Terminal Block 2 Designations

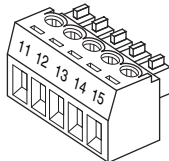
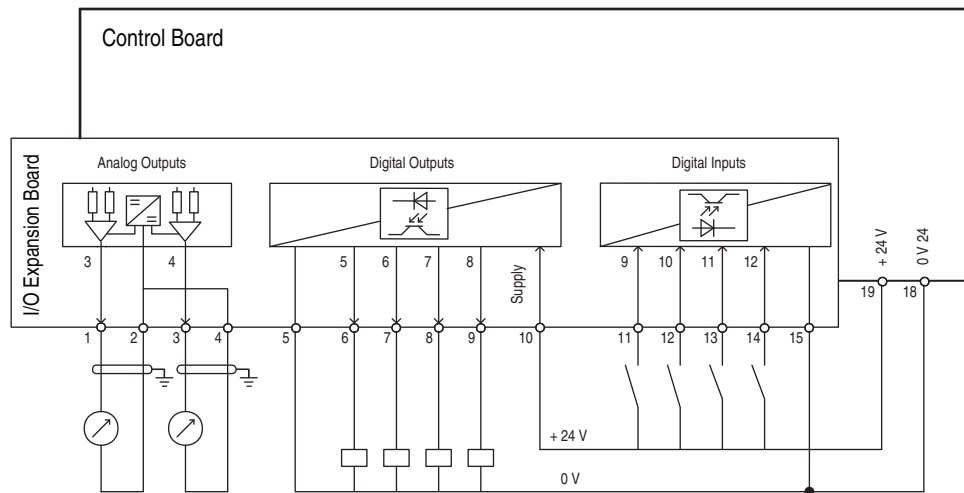
	No.	Signal	Description
	11	Digital Input 9	Max volt. +30V, max cur. 15V/3.2mA, 24V/5mA, and 30V/6.4mA.
	12	Digital Input 10	
	13	Digital Input 11	
	14	Digital Input 12	
	15	Digital Input Common	

Figure 95 - I/O Expansion Board Wiring Diagram



PowerFlex DC 115V AC to 24V DC I/O Converter Circuit Board

The 115V AC to 24V DC I/O converter board allows you to convert 115V AC digital input signals to 24V DC digital input signals to interface with the standard digital I/O on the PowerFlex DC drive control board. This board provides these additional I/O signals.

- Eight opto isolated 115V AC digital inputs
- Eight interface outputs for the digital inputs on control board of the drive
- Two input terminals for the 24V DC power supply voltage

Table 30 - Recommended Signal Wire Size

Wire Type and Size			Tightening Torque N-m (lb-in)
Flexible (mm ²)	multi-core (mm ²)	AWG	
0.14...1.5	0.14...1.5	28...16	0.4 (3.5)

A 75 x 2.5 x 0.4 mm (3.0 x 0.1 x 0.02 in.) flathead screwdriver is recommended for connecting wire to the terminal block inputs. Strip the ends of the cables to a length of 6.5 mm (0.26 in.).

Figure 96 - I/O Converter Board M_IN Terminal Block Designations

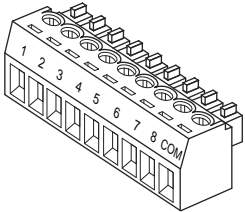
	No.	Signal	Description
	1	Digital Input 1	Rated input voltage: 115V AC $\pm 10\%$ 50 - 60Hz. ON input voltage: 115V AC $\pm 10\%$ OFF input voltage: 0 - 70V AC ON input current: 4 - 5.5mA
	2	Digital Input 2	
	3	Digital Input 3	
	4	Digital Input 4	
	5	Digital Input 5	
	6	Digital Input 6	
	7	Digital Input 7	
	8	Digital Input 8	
	Co m	Digital Input Common	

Table 31 - I/O Converter Board M_OUT Terminal Block Designations

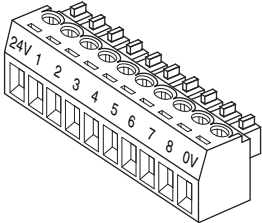
	No.	Signal	Description
	24V	+24VDC Supply	24V DC $\pm 10\%$, 40 mA power supply. max load 120 mA. Supply power can be provided by the +24V DC supply on the Control board I/O (terminal 19 - see Figure 97 on 127) or an external source (see Figure 98 on page 127). Output type: Open collector, PNP type with 15kohm pull-down Output current: 10 mA max. Delay time hw OFF to ON: 5 ms (typ.) Delay time hw ON to OFF: 50 ms (typ.)
	1	Digital Output 1	
	2	Digital Output 2	
	3	Digital Output 3	
	4	Digital Output 4	
	5	Digital Output 5	
	6	Digital Output 6	
	7	Digital Output 7	
	8	Digital Output 8	
	0V	24V Common	

Figure 97 - I/O Converter Board with Internal Supply

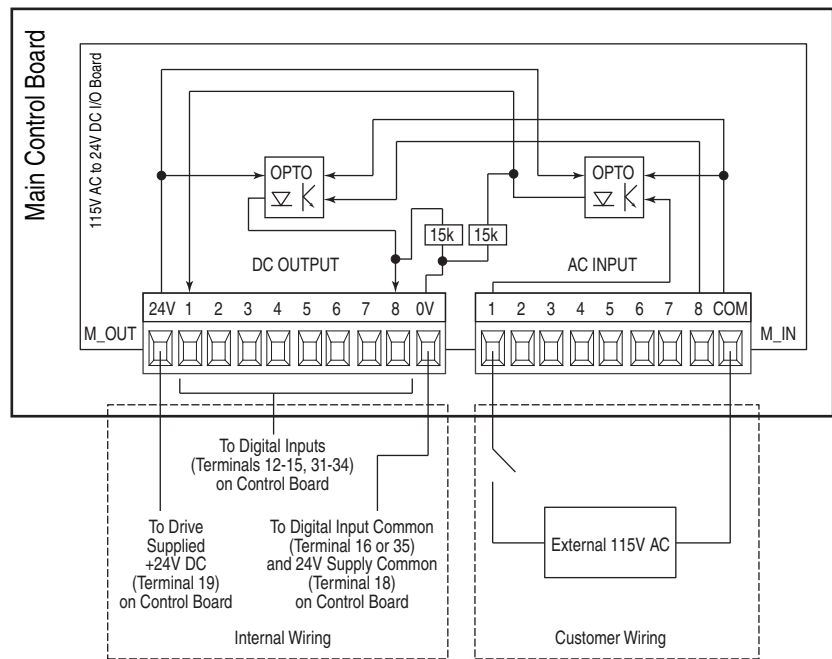
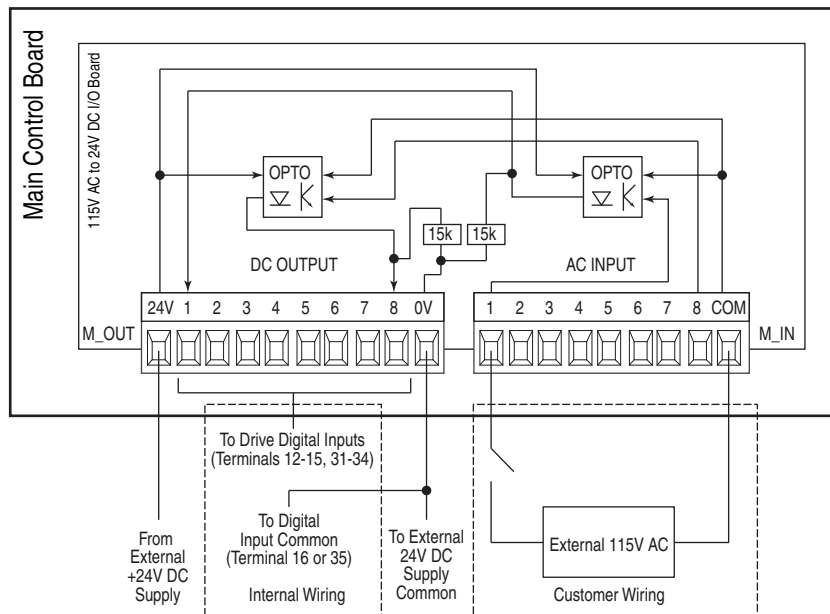


Figure 98 - I/O Converter Board with External Supply

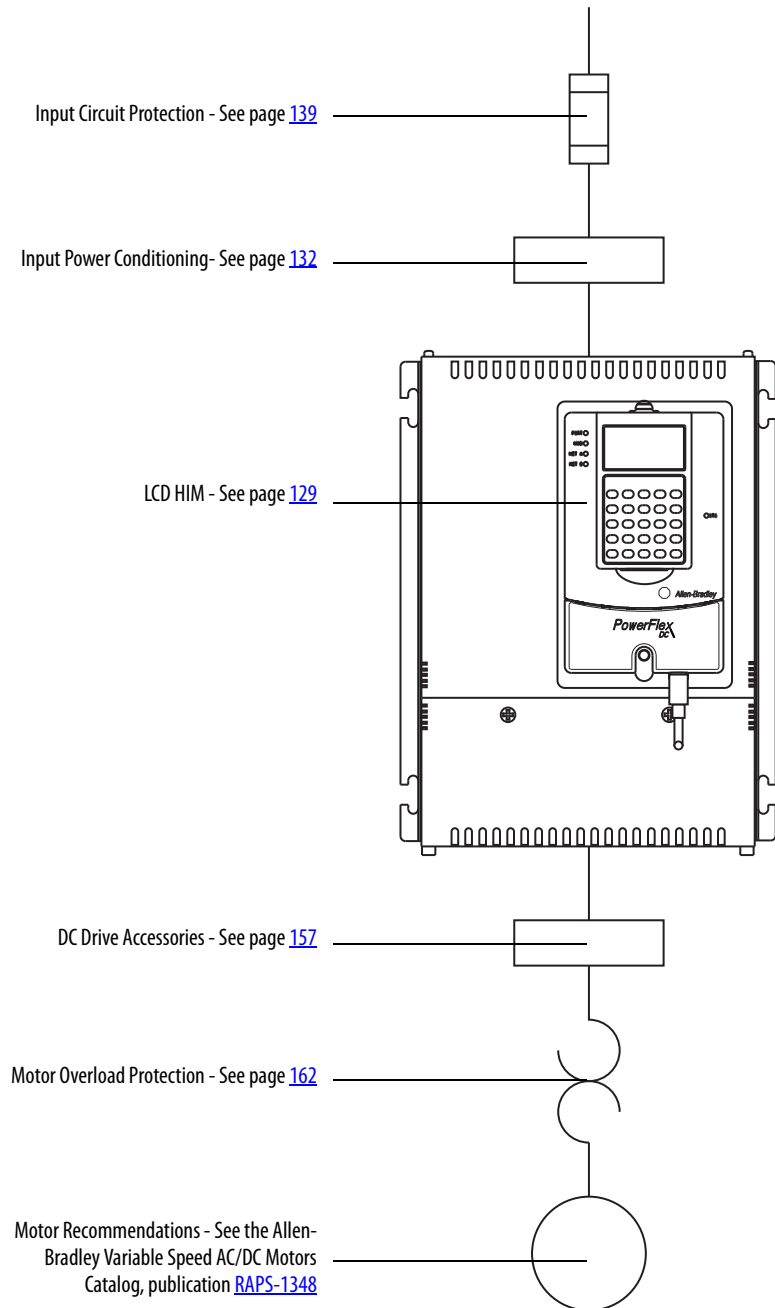


Installation Considerations for PowerFlex DC Drives

The PowerFlex Digital DC drive has the following built in protective features to help simplify installation.

- Ground fault protection during start up and running ensures reliable operation
- Electronic motor overload protection increases motor life

There are many other factors that must be considered for optimal performance in any given application. The block diagram below highlights the primary installation considerations.



PowerFlex DC Factory-installed Options

Each PowerFlex DC drive includes one encoder and DC analog tachometer input. No other factory installed options are available at this time.

PowerFlex DC User-installed Options

The options listed below cannot be ordered via the drive catalog number and must be ordered separately.

Human Interface and Wireless Interface Modules



Description	Handheld/Local (Drive Mount)	Remote (Panel Mount) IP66, NEMA/UL Type 4x/12 ⁽¹⁾
	Cat. No.	Cat. No.
No HIM (Blank Plate)	20-HIM-A0	—
LCD Display, Full Numeric Keypad	20-HIM-A3	20-HIM-C3S ⁽²⁾
LCD Display, Programmer Only	20-HIM-A5	20-HIM-C3S ⁽²⁾
Enhanced, LCD, Full Numeric	20-HIM-A6	—

- (1) For indoor use only.
- (2) Includes a 1202-C30 interface cable (3 meters) for connection to drive.

Human Interface Module Accessories

Description	Cat. No.
Bezel Kit for LCD HIMs, NEMA/UL Type 1 ⁽¹⁾	20-HIM-B1
PowerFlex HIM Interface Cable, 1 m (39 in.) ⁽²⁾	20-HIM-H10
Cable Kit (Male-Female) ⁽³⁾	
0.33 Meters (1.1 Feet)	1202-H03
1 Meter (3.3 Feet)	1202-H10
3 Meter (9.8 Feet)	1202-H30
9 Meter (29.5 Feet)	1202-H90
DPI/SCANport™ One to Two Port Splitter Cable	1203-S03

- (1) Includes a 1202-C30 interface cable (3 meters) for connection to drive.
- (2) Required only when HIM is used as handheld or remote.
- (3) Required in addition to 20-HIM-H10 for distances up to a total maximum of 10 Meters (32.8 Feet).

I/O Option Kit

Description	Cat. No.
I/O Expansion board	20P-S5V62
115V AC to 24V DC 8 Channel I/O Converter Board	20P-S520L

Feedback Option Kit

Description	Cat. No.
Resolver Feedback Option Module	20P-RES-A0

Communication Option Kits

Description	Cat. No.
BACnet® MS/TP RS485 Communication Adapter	20-COMM-B
ControlNet™ Communication Adapter (Coax)	20-COMM-C
DeviceNet™ Communication Adapter	20-COMM-D
EtherNet/IP™ Communication Adapter	20-COMM-E
HVAC Communication Adapter	20-COMM-H
Interbus™ Communication Adapter	20-COMM-I
PROFIBUS™ DP Communication Adapter	20-COMM-P
ControlNet™ Communication Adapter (Fiber)	20-COMM-Q
Remote I/O Communication Adapter	20-COMM-R
RS485 DF1 Communication Adapter	20-COMM-S
External Communications Kit Power Supply	20-XCOMM-PS1
DPI External Communications Kit	20-XCOMMDC-BASE
External DPI I/O Option Board ⁽¹⁾	20-XCOMMIO-OPT1
Compact I/O to DPI/SCANport Module1769-SM1	1769-SM1
Serial Null Modem Adapter	1203-SNM
Smart Self-powered Serial Converter (RS232) includes 1203-SFC and 1202-C10 Cables	1203-SSS
Universal Serial Bus™ (USB) Converter includes 2m USB, 20-HIM-H10 & 22-HIM-H10 Cables	1203-USB

(1) For use only with External DPI Communications Kits 20-XCOMM-DCBASE.

PC Programming Software

Description	
DriveTools™ SP Software	Contact your Rockwell Automation Distributor or sales representative for local pricing. For more information visit: http://ab.rockwellautomation.com/drives/software/9303-drivetools-sp/
DriveExplorer™ Software (Lite/Full) ⁽¹⁾	DriveExplorer Lite is available for free download at: http://www.ab.com/drives/driveexplorer/free_download.html
Pocket DriveExplorer™ Software	For more information visit: http://ab.rockwellautomation.com/Drives/Software/9306-DriveExplorer

(1) Set-up wizards are available for use with DriveTools SP and DriveExplorer (Lite/Full) only.

Grounding PowerFlex DC Drives

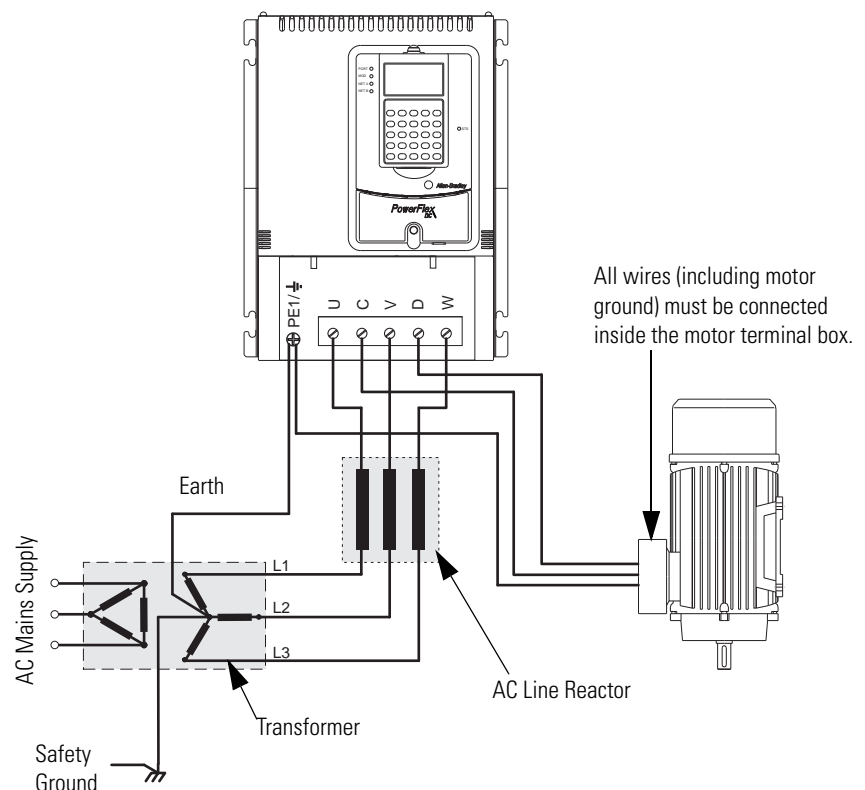
The drive Safety Ground - PE must be connected to system ground. Ground impedance must conform to the requirements of national and local industrial safety regulations and/or electrical codes. The integrity of all ground connections should be periodically checked.

For installations within a cabinet, a single safety ground point or ground bus bar connected directly to building steel should be used. All circuits including the AC input ground conductor should be grounded independently and directly to this point/bar.



ATTENTION: In order to comply with the essential requirements of the CE Low Voltage Directive 2006/95/EC, PowerFlex DC drives may not be powered from a corner-earthed (TN with one phase earthed) supply system. When operating PowerFlex DC drives from an IT or impedance-earthed supply system, only temporary operation is permitted after an earth fault is detected in the power system.

Figure 99 - PowerFlex DC Drive Typical Grounding



Safety Ground (PE)

This is the safety ground for the drive that is required by code. This point must be connected to adjacent building steel (girder, joist), a floor ground rod or bus bar (see above). Grounding points must comply with national and local industrial safety regulations and/or electrical codes.

Power Feeder

Each power feeder from the substation transformer to the drive must be provided with properly sized ground cables. The conduit or cable armor should be bonded to the substation ground at both ends. Each transformer enclosure and/or frame must be bonded to ground at a minimum of two locations.

Encoder/Resolver Ground Connections

If used, must be routed in grounded steel conduit. The conduit must be grounded at both ends. The encoder/resolver cable shield must be connected to the shield ground on the drive side. Do not connect the encoder/resolver cable shield to ground on the motor side.

Tachometer Ground Connections

If used, ground connections must be routed in grounded steel conduit. The conduit must be grounded at both ends. Ground the cable shield at the drive end only using the shield clamps on the grounded metal plate supporting the control board (see I/O Terminal Block Locations on page 71 for shield clamp location).

Input Devices for PowerFlex DC Drives

Isolation Transformers

Isolation Transformers are available for installations that have specific types of AC supply configurations or require drive protection due to AC line disturbances.

Three Phase Primary Voltage			Three Phase Secondary Voltage		
kVA	kW (Hp)	Voltage	230V AC Cat. No.	460V AC Cat. No.	575V AC Cat. No.
5	1.2...2.2 (1.5...3)	230	1321-3TW005-AA	1321-3TW005-AB	N/A
		460	1321-3TW005-BA	1321-3TW005-BB	N/A
		575	1321-3TW005-CA	1321-3TW005-CB	N/A
7.5	3.7 (5)	230	1321-3TW007-AA	1321-3TW007-AB	N/A
		460	1321-3TW007-BA	1321-3TW007-BB	N/A
		575	1321-3TW007-CA	1321-3TW007-CB	N/A
11	5.5 (7.5)	230	1321-3TW011-AA	1321-3TW011-AB	N/A
		460	1321-3TW011-BA	1321-3TW011-BB	N/A
		575	1321-3TW011-CA	1321-3TW011-CB	N/A

Three Phase Primary Voltage			Three Phase Secondary Voltage		
kVA	kW (Hp)	Voltage	230V AC Cat. No.	460V AC Cat. No.	575V AC Cat. No.
14	7.5 (10)	230	1321-3TW014-AA	1321-3TW014-AB	N/A
		460	1321-3TW014-BA	1321-3TW014-BB	N/A
		575	1321-3TW014-CA	1321-3TW014-CB	N/A
20	11 (15)	230	1321-3TW020-AA	1321-3TW020-AB	N/A
		460	1321-3TW020-BA	1321-3TW020-BB	N/A
		575	1321-3TW020-CA	1321-3TW020-CB	N/A
27	15 (20)	230	1321-3TW027-AA	1321-3TW027-AB	N/A
		460	1321-3TW027-BA	1321-3TW027-BB	N/A
		575	1321-3TW027-CA	1321-3TW027-CB	N/A
34	18.5 (25)	230	1321-3TW034-AA	1321-3TW034-AB	N/A
		460	1321-3TW034-BA	1321-3TW034-BB	N/A
		575	1321-3TW034-CA	1321-3TW034-CB	N/A
40	22 (30)	230	1321-3TW040-AA	1321-3TW040-AB	N/A
		460	1321-3TW040-BA	1321-3TW040-BB	N/A
		575	1321-3TW040-CA	1321-3TW040-CB	N/A
51	30 (40)	230	1321-3TW051-AA	1321-3TW051-AB	N/A
		460	1321-3TW051-BA	1321-3TW051-BB	N/A
		575	1321-3TW051-CA	1321-3TW051-CB	N/A
63	37 (50)	230	1321-3TH063-AA	1321-3TH063-AB	1321-3TH063-AC
		460	1321-3TH063-BA	1321-3TH063-BB	1321-3TH063-BC
		575	1321-3TH063-CA	1321-3TH063-CB	1321-3TH063-CC
75	45 (60)	230	1321-3TH075-AA	1321-3TH075-AB	1321-3TH075-AC
		460	1321-3TH075-BA	1321-3TH075-BB	1321-3TH075-BC
		575	1321-3TH075-CA	1321-3TH075-CB	1321-3TH075-CC
93	56 (75)	230	1321-3TH093-AA	1321-3TH093-AB	1321-3TH093-AC
		460	1321-3TH093-BA	1321-3TH093-BB	1321-3TH093-BC
		575	1321-3TH093-CA	1321-3TH093-CB	1321-3TH093-CC
118	75 (100)	230	1321-3TH118-AA	1321-3TH118-AB	1321-3TH118-AC
		460	1321-3TH118-BA	1321-3TH118-BB	1321-3TH118-BC
		575	1321-3TH118-CA	1321-3TH118-CB	1321-3TH118-CC
145	93 (125)	230	1321-3TH145-AA	1321-3TH145-AB	1321-3TH145-AC
		460	1321-3TH145-BA	1321-3TH145-BB	1321-3TH145-BC
		575	1321-3TH145-CA	1321-3TH145-CB	1321-3TH145-CC
175	112 (150)	230	1321-3TH175-AA	1321-3TH175-AB	1321-3TH175-AC
		460	1321-3TH175-BA	1321-3TH175-BB	1321-3TH175-BC
		575	1321-3TH175-CA	1321-3TH175-CB	1321-3TH175-CC
220	145 (200)	230	1321-3TH220-AA	1321-3TH220-AB	1321-3TH220-AC
		460	1321-3TH220-BA	1321-3TH220-BB	1321-3TH220-BC
		575	1321-3TH220-CA	1321-3TH220-CB	1321-3TH220-CC

Three Phase Primary Voltage			Three Phase Secondary Voltage		
kVA	kW (Hp)	Voltage	230V AC Cat. No.	460V AC Cat. No.	575V AC Cat. No.
275	187 (250)	230	1321-3TH275-AA	1321-3TH275-AB	1321-3TH275-AC
		460	1321-3TH275-BA	1321-3TH275-BB	1321-3TH275-BC
		575	1321-3TH275-CA	1321-3TH275-CB	1321-3TH275-CC
330	224 (300)	230	1321-3TH330-AA	1321-3TH330-AB	1321-3TH330-AC
		460	1321-3TH330-BA	1321-3TH330-BB	1321-3TH330-BC
		575	1321-3TH330-CA	1321-3TH330-CB	1321-3TH330-CC
440	298 (400)	230	N/A	1321-3TH440-AB	1321-3TH440-AC
		460	N/A	1321-3TH440-BB	1321-3TH440-BC
		575	N/A	1321-3TH440-CB	1321-3TH440-CC
550	373 (500)	230	N/A	1321-3TH550-AB	1321-3TH550-AC
		460	N/A	1321-3TH550-BB	1321-3TH550-BC
		575	N/A	1321-3TH550-CB	1321-3TH550-CC
660	448 (600)	230	N/A	1321-3TH660-AB	1321-3TH660-AC
		460	N/A	1321-3TH660-BB	1321-3TH660-BC
		575	N/A	1321-3TH660-CB	1321-3TH660-CC
770	522 (700)	230	N/A	1321-3TH770-AB	1321-3TH770-AC
		460	N/A	1321-3TH770-BB	1321-3TH770-BC
		575	N/A	1321-3TH770-CB	1321-3TH770-CC
880	597 (800)	230	N/A	1321-3TH880-AB	1321-3TH880-AC
		460	N/A	1321-3TH880-BB	1321-3TH880-BC
		575	N/A	1321-3TH880-CB	1321-3TH880-CC

AC Input Line Reactors and Contactors

If a DC output contactor is used, an AC input contactor is not needed.

Table 32 - 230V AC Input Drives

Regenerative Drive Cat. No.	DC Amps	AC Line Amps	Hp	IP00 (Open Style) Line Reactor Cat No.	Line Reactor kW (Hp)	AC Input Contactor Cat. No.
20P41AB7P0	7	5.7	1.5	1321-3R8-A	.75 (1)	100-C12D10
20P41AB9P0	9	7.4	2	1321-3R12-A	1.49 (2)	100-C12D10
20P41AB012	12	9.8	3	1321-3R18-A	0.75...3.7 (1...5)	100-C12D10
20P41AB020	20	16	5	1321-3R18-A	0.75...3.7 (1...5)	100-C23D10
20P41AB029	29	24	7.5	1321-3R55-A	5.5...11 (7.5...15)	100-C30D10
20P41AB038	38	31	10	1321-3R55-A	5.5...11 (7.5...15)	100-C37D10
20P41AB055	55	45	15	1321-3R55-A	5.5...11 (7.5...15)	100-C60D10
20P41AB073	73	60	20	1321-3R80-A	15 (20)	100-C60D10
20P41AB093	93	76	25	1321-3R100-A	18.5...22 (25...30)	100-C85D10
20P41AB110	110	90	30	1321-3R100-A	18.5...22 (25...30)	100-D110D11
20P41AB146	146	119	40	1321-3R160-A	30...37 (40...50)	100-D140D11
20P41AB180	180	147	50	1321-3R160-A	30...37 (40...50)	100-D180D11
20P41AB218	218	178	60	1321-3RB250-A	45...56 (60...75)	100-D180D11
20P41AB265	265	217	75	1321-3RB250-A	45...56 (60...75)	100-D250ED11
20P41AB360	360	294	100	1321-3RB320-A	75 (100)	100-D300ED11
20P41AB434	434	355	125	1321-3RB400-A	93 (125)	100-D420ED11
20P41AB521	521	426	150	1321-3R500-A	112 (150)	100-D630ED11
20P41AB700	700	572	200	1321-3R600-A	149 (200)	100-D630ED11
20P41AB875	875	715	250	1321-3R750-A	186 (250)	100-D860ED11
20P41AB1K0	1050	858	300	1321-3R850-A	224 (300)	100-D860ED11

Table 33 - 460V AC Input Drives

Non-Regenerative Drive Cat. No.	Regenerative Drive Cat. No.	DC Amps	AC Line Amps	Hp	IP00 (Open Style) Line Reactor Cat No.	Line Reactor kW (Hp)	AC Input Contactor Cat. No.
20P21AD4P1	20P41AD4P1	4.1	3.3	2	1321-3R4-A	.55 (.75)	100-C12D10
20P21AD6P0	20P41AD6P0	6	4.9	3	1321-3R8-A	.75 (1)	100-C12D10
20P21AD010	20P41AD010	10	8.2	5	1321-3R18-B	1.5...7.5 (2...10)	100-C12D10
20P21AD014	20P41AD014	14	11.4	7.5	1321-3R18-B	1.5...7.5 (2...10)	100-C12D10

Non-Regenerative Drive Cat. No.	Regenerative Drive Cat. No.	DC Amps	AC Line Amps	Hp	IP00 (Open Style) Line Reactor Cat No.	Line Reactor kW (Hp)	AC Input Contactor Cat. No.
20P21AD019	20P41AD019	19	15.5	10	1321-3R18-B	1.5...7.5 (2...10)	100-C23D10
20P21AD027	20P41AD027	27	22.1	15	1321-3R55-B	11...22 (15...30)	100-C23D10
20P21AD035	20P41AD035	35	28.6	20	1321-3R55-B	11...22 (15...30)	100-C30D10
20P21AD045	20P41AD045	45	36.8	25	1321-3R55-B	11...22 (15...30)	100-C37D10
20P21AD052	20P41AD052	52	42.5	30	1321-3R55-B	11...22 (15...30)	100-C43D10
20P21AD073	20P41AD073	73	59.6	40	1321-3R80-B	30 (40)	100-C60D10
20P21AD086	20P41AD086	86	70.3	50	1321-3R100-B	37...45 (50...60)	100-C85D10
20P21AD100	20P41AD100	100	81.7	60	1321-3R100-B	37...45 (50...60)	100-C85D10
20P21AD129	20P41AD129	129	105.4	75	1321-3R160-B	56...75 (75...100)	100-D110D11
20P21AD167	20P41AD167	167	136.4	100	1321-3R160-B	56...75 (75...100)	100-D140D11
20P21AD207	20P41AD207	207	169.1	125	1321-3RB250-B	93...112 (125...150)	100-D180D11
20P21AD250	20P41AD250	250	204.3	150	1321-3RB250-B	93...112 (125...150)	100-D210ED11
20P21AD330	20P41AD330	330	269.6	200	1321-3RB320-B	149 (200)	100-D300ED11
20P21AD412	20P41AD412	412	336.6	250	1321-3RB400-B	186.4 (250)	100-D420ED11
20P21AD495	20P41AD495	495	404.4	300	1321-3R500-B	223.7 (300)	100-D420ED11
20P21AD667	20P41AD667	667	544.9	400	1321-3R600-B	298.3 (400)	100-D630ED11
20P21AD830	20P41AD830	830	678.1	500	1321-3R750-B	372.8 (500)	100-D860ED11
20P21AD996	20P41AD996	996	813.7	600	1321-3R850-B	447.4 (600)	100-D860ED11
20P21AD1K1	20P41AD1K1	1162	949.4	700	1321-3R1000-B	552 (700)	100-G860KD22
20P21AD1K3	20P41AD1K3	1328	1085.0	800	(1)	–	100-G860KD22
20P21AD1K4	20P41AD1K4	1494	1220.6	900	(2)	–	100-G1200KD12

(1) No Line Reactor available for this drive rating. Use the recommended Isolation Transformer: 1321-3TH880-BB.
(2) No Line Reactor or Isolation Transformer available for this drive rating - must be sourced locally.

Table 34 - 575V AC Input Drives

Non-Regenerative Drive Cat. No.	Regenerative Drive Cat. No.	DC Amps	AC Line Amps	Hp	IP00 (Open Style) Line Reactor Cat No.	Line Reactor kW (Hp)	AC Input Contactor Cat. No.
20P21AE067	20P41AE067	67.5	55.1	50	1321-3R55-B	37 (50)	100-C60D10
20P21AE101	20P41AE101	101.25	82.7	75	1321-3R100-B	56 (75)	100-C85D10
20P21AE135	20P41AE135	135	110.3	100	1321-3R130-B	75 (100)	100-D110D11
20P21AE270	20P41AE270	270	220.6	200	1321-3RB250-B	149 (200)	100-D250ED11
20P21AE405	20P41AE405	405	330.9	300	1321-3RB320-B	224 (300)	100-D420ED11
20P21AE540	20P41AE540	540	441.2	400	1321-3RB500-B	298 (400)	100-D630ED11
20P21AE675	20P41AE675	675	551.5	500	1321-3R600-B	373 (500)	100-D630ED11
20P21AE810	20P41AE810	810	661.8	600	1321-3R600-B	447 (600)	100-D860ED11
20P21AE1K0	20P41AE1K0	1080	882.4	800	1321-3R750-B	597 (800)	100-G700KD22
20P21AE1K2	20P41AE1K2	1215	992.7	900	1321-3R850-B	671 (900)	100-G860KD22
20P21AE1K3	20P41AE1K3	1350	1103.0	1000	1321-3R1000-B	746 (1000)	100-G1000KD12
20P21AE1K6	20P41AE1K6	1687.5	1378.7	1250	(1)	–	(2)

(1) No Line Reactor or Isolation Transformer available for this drive rating - must be sourced locally.

(2) No AC Input Contactor available for this drive rating - must be sourced locally.

Table 35 - 690V AC Input Drives

Non-Regenerative Drive Cat. No.	Regenerative Drive Cat. No.	DC Amps	AC Line Amps	Hp	IP00 (Open Style) Line Reactor Cat No.	Line Reactor kW (Hp)	AC Input Contactor Cat. No.
20P21AF452	20P41AF452	452	369	400	1321-3RB500-C	–	100-D420ED11
20P21AF565	20P41AF565	565	462	500	1321-3RB600-C	–	100-D630ED11
20P21AF678	20P41AF678	678	554	600	Line Reactors or Isolation Transformers for 690V AC input voltage drives must be sourced locally.	–	100-D630ED11
20P21AF791	20P41AF791	791	646	700		–	100-D860ED11
20P21AF904	20P41AF904	904	739	800		–	100-D860ED11
20P21AF1K0	20P41AF1K0	1017	831	900		–	100-D860ED11
20P21AF1K1	20P41AF1K1	1130	923	1000		–	100-G700KD22
20P21AF1K2	20P41AF1K2	1243	1016	1100		–	100-G860KD22
20P21AF1K4	20P41AF1K4	1412.5	1154	1250		–	100-G1200KD12
20P21AF1K5	20P41AF1K5	1582	1292	1400		–	100-G1200KD12

EMC Filters

PowerFlex DC drives require the use of an external EMC filter in order to comply with the EMC directive (2004/109/EC) and emission limits of EN 61800-3: 2004. PowerFlex DC drives have been tested and verified for compliance to the emission limits of EN 61800-3: 2004 using only the specific input filters and motor cable lengths indicated in this table:

Drive Frame Catalog Number	Standard / Limits (Compliance with any of the limits in the table below satisfies RF emission requirements for the EMC Directive)				
	EN61800-3 Category C1 EN61000-6-3 CISPR 11 Group 1 Class B	EN61800-3 Category C2 EN61000-6-4 CISPR11 Group 1 Class A...P ≤ 20kVA	CISPR11 Group 1 Class A...P > 20kVA	EN61800-3 Category C3...I ≤ 100A	EN61800-3 Category C3...I > 100A
Frame A 20Px1Ax4P1... 20Px1Ax129	Compliance may be possible with supplementary mitigation (Consult factory)	Compliance may be possible with supplementary mitigation (Consult factory)	RF line filter required ⁽²⁾ 50m motor cable limit	RF line filter required ⁽²⁾ 50m motor cable limit	RF line filter required ⁽²⁾ 50m motor cable limit
Frame B 20Px1Ax167... 20Px1Ax412	Compliance may be possible with supplementary mitigation (Consult factory)	RF line filter required ⁽¹⁾ 50m motor cable limit	RF line filter required ⁽¹⁾ 50m motor cable limit	RF line filter required ⁽¹⁾ 50m motor cable limit	RF line filter required ⁽¹⁾ 50m motor cable limit
Frame C 20Px1Ax495... 20Px1Ax667	Compliance may be possible with supplementary mitigation (Consult factory)	Compliance may be possible with supplementary mitigation (Consult factory)	RF line filter required ⁽³⁾ 50m motor cable limit	RF line filter required ⁽³⁾ 50m motor cable limit	RF line filter required ⁽³⁾ 50m motor cable limit
Frame D 20Px1Ax... 20Px1Ax	Compliance may be possible with supplementary mitigation (Consult factory)	Compliance may be possible with supplementary mitigation (Consult factory)	Compliance may be possible with supplementary mitigation (Consult factory)	RF line filter required ⁽⁴⁾ 50m motor cable limit	RF line filter required ⁽⁴⁾ 50m motor cable limit
	More Stringent Limits ←			→ Less Stringent Limits	

- (1) RF 3xxx-MHU EMC filter from Rasmi Electronics Ltd. xxx designates filter current rating. Rasmi EMC filters are manufactured by Rasmi Electronics Ltd. Refer to the manufacturer's literature for details.
- (2) RF 3xxx-SIEI EMC filter from Rasmi Electronics Ltd. xxx designates filter current rating. Rasmi EMC filters are manufactured by Rasmi Electronics Ltd. Refer to the manufacturer's literature for details.
- (3) RF 3xxx-MHU EMC filter from Rasmi Electronics Ltd. xxx designates filter current rating. Rasmi EMC filters are manufactured by Rasmi Electronics Ltd. Refer to the manufacturer's literature for details.
- (4) EPCOS B84143B Type S081 EMC filter from EPCOS AG. EPCOS EMC filters are manufactured by EPCOS AG. Refer to the manufacturer's literature for details.

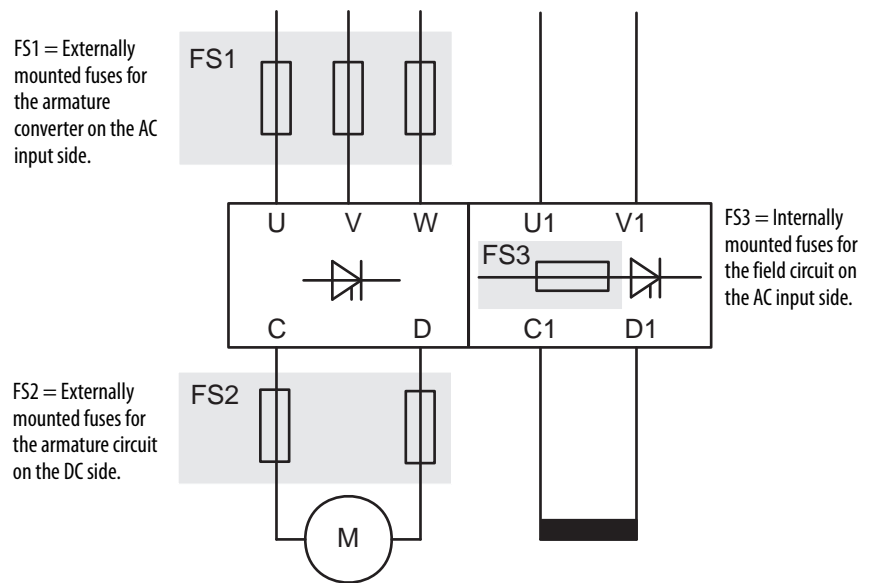
A list of recommended alternate filters can be used in place of the Rasmi and EPCOS filters listed in the table above. See Alternate EMC Filters in Appendix A of the PowerFlex Digital DC Drive User Manual, publication [20P-UM001](#).

PowerFlex DC Drives Circuit Protection

Drive Power

The tables on the following pages provide drive ratings and the recommended fuses for protecting the armature and field circuits. Externally mounted fuses (as indicated in the figures below) must be sourced separately when installing the drive. Internally mounted fuses are provided with the drive. See page [146](#) for frames C and D fuse information.

Figure 100 - Frame A and B Fuse Designations



Frame A and B Recommended AC Input Line Fuses

AC input line fuses are externally mounted for frame A and B drives and must be sourced separately. See Fuse Code FS1 in [Figure 100](#) on page [139](#).

Table 36 - 230V AC Input Drives

Frame	Drive Current Rating Code	DC Amps	AC Line Amps	Bussmann				Ferraz Shawmut (Gould Shawmut)	
				Ferrule FWP Type	Ferrule Fuse Block	North American FWP Type	North American Fuse Block	Ferrule A70QS Type	North American A70P / A70QS Type
A	7P0	7	5.7	FWP-10A14F	CH143D	FWP-10B	–	A70QS10-14F	A70P10-4
	9P0	9	7.4	FWP-15A14F		FWP-15B	–	A70QS16-14F	A70P15-4
	012	12	9.8	FWP-20A14F		FWP-20B	–	A70QS20-14F	A70P20-4
	020	20	16	FWP-25A14F		FWP-25B	–	A70QS25-14F	A70QS25-4
	029	29	24	FWP-40A22F	CH223D	FWP-40B	–	A70QS40-22F	A70QS40-4
	038	38	31	FWP-63A22F		FWP-60B	–	A70QS63-22F	A70QS60-4
	055	55	45	FWP-80A22F		FWP-80B	–	A70QS80-22F	A70QS80-4
	073	73	60	–	–	FWP-100A	–	–	A70QS100-4K
	093	93	76	–	–	FWP-150A	BH-1133	–	A70QS150-4K
	110	110	90	–	–	FWP-175A		–	A70QS175-4K
B	146	146	119	–	–	FWP-250A		–	A70QS250-4
	180	180	147	–	–	FWP-300A	–	A70QS300-4	
	218	218	178	–	–	FWP-350A	–	A70QS350-4	
	265	265	217	–	–	FWP-400	BH-3144	–	A70QS400-4
	360	360	294	–	–	FWP-600A		–	A70QS600-4K
	434	434	355	–	–	FWP-600A		–	A70QS600-4

Table 37 - 460V AC Input Drives

Frame	Drive Current Rating Code	DC Amps	AC Line Amps	Bussmann				Ferraz Shawmut (Gould Shawmut)	
				Ferrule FWP Type	Ferrule Fuse Block	North American FWP Type	North American Fuse Block	Ferrule A70QS Type	North American A70P / A70QS Type
A	4P1	4.1	3.3	FWP-10A14F	CH143D	FWP-10B	–	A70QS10-14F	A70P10-4
	6P0	6	4.9	FWP-10A14F		FWP-10B	–	A70QS10-14F	A70P10-4
	010	10	8.2	FWP-20A14F		FWP-20B	–	A70QS20-14F	A70P25-4
	014	14	11.4	FWP-25A14F		FWP-25B	–	A70QS25-14F	A70P25-4
	019	19	15.5	FWP-25A14F		FWP-25B	–	A70QS25-14F	A70P25-4
	027	27	22.1	FWP-40A22F	CH223D	FWP-40B	–	A70QS40-22F	A70QS40-4
	035	35	28.6	FWP-63A22F		FWP-60B	–	A70QS63-22F	A70QS60-4
	045	45	36.8	FWP-80A22F		FWP-80B	–	A70QS80-22F	A70QS80-4
	052	52	42.5	FWP-80A22F		FWP-80B	–	A70QS80-22F	A70QS80-4
	073	73	59.6	–	–	FWP-100A	–	–	A70QS100-4K
	086	86	70.3	–	–	FWP-150A	BH-1133	–	A70QS150-4K
	100	100	81.7	–	–	FWP-175A		–	A70QS175-4K
129	129	105.4	–	–	FWP-175A	–		A70QS175-4K	
B	167	167	136.4	–	–	FWP-300A		–	A70QS300-4
	207	207	169.1	–	–	FWP-350A	–	A70QS350-4	
	250	250	204.3	–	–	FWP-400A	BH-3144	–	A70QS400-4
	330	330	269.6	–	–	FWP-600A		–	A70QS600-4K
	412	412	336.6	–	–	FWP-600A		–	A70QS600-4

Table 38 - 575V AC Input Drives

Frame	Drive Current Rating Code	DC Amps	AC Line Amps	Bussmann		Ferraz Shawmut (Gould Shawmut)
				North American FWP Type	North American FWP Fuse Block	North American A70QS Type
B	067	67.5	55.1	FWP-100A	–	A70QS100-4
	101	101.3	82.7	FWP-175A	BH-1133	A70QS175-4K
	135	135	110.3	FWP-225A		A70QS225-4
	270	270	220.6	FWP-450A	BH-3144	A70QS450-4
	405	405	330.9	FWP-600A		A70QS600-4K

Frame A and B Recommended Armature DC Output Fuses

Armature DC output fuses are externally mounted for frame A and B drives and must be sourced separately. These fuses are required on four quadrant drives only, but highly recommended on two quadrant drives. See Fuse Code FS2 in [Figure 100](#) on page 139.

Table 39 - 230V AC Input Drives

Frame	Drive Current Rating Code	DC Amps	AC Line Amps	Bussmann				Ferraz Shawmut (Gould Shawmut)	
				Ferrule FWP Type	Ferrule Fuse Block	North American FWP Type	North American Fuse Block	Ferrule A70QS Type	North American A70P / A70QS Type
A	7P0	7	5.7	FWP-15A14F	CH142D	FWP-15B	–	A70QS16-14F	A70P15-4
	9P0	9	7.4	FWP-20A14F		FWP-20B	–	A70QS20-14F	A70P20-4
	012	12	9.8	FWP-25A14F		FWP-25B	–	A70QS25-14F	A70P25-4
	020	20	16	FWP-40A14F		FWP-40B	–	A70QS40-14F	A70QS40-4
	029	29	24	FWP-63A22F	CH222D	FWP-60B	–	A70QS63-22F	A70QS60-4
	038	38	31	FWP-80A22F		FWP-80B	–	A70QS80-22F	A70QS80-4
	055	55	45	–	–	FWP-125A	BH-1133	–	A70QS125-4K
	073	73	60	–	–	FWP-150A		–	A70QS150-4K
	093	93	76	–	–	FWP-200A		–	A70QS200-4K
	110	110	90	–	–	FWP-225A		–	A70QS250-4
B	146	146	119	–	–	FWP-300A	BH-3144	–	A70QS300-4
	180	180	147	–	–	FWP-350A		–	A70QS350-4
	218	218	178	–	–	FWP-450A		–	A70QS450-4
	265	265	217	–	–	FWP-600A		–	A70QS600-4K
	360	360	294	–	–	FWP-700A		–	A70QS700-4
	434	434	355	–	–	FWP-900A		–	A70P900-4

Table 40 - 460V AC Input Drives

Frame	Drive Current Rating Code	DC Amps	AC Line Amps	Bussmann				Ferraz Shawmut (Gould Shawmut)	
				Ferrule FWP Type	Ferrule Fuse Block	North American FWP Type	North American Fuse Block	Ferrule A70QS Type	North American A70P / A70QS Type
A	4P1	4.1	3.3	FWP-10A14F	CH142D	FWP-10B	–	A70QS10-14F	A70P10-4
	6P0	6	4.9	FWP-15A14F		FWP-15B	–	A70QS16-14F	A70P15-4
	010	10	8.2	FWP-20A14F		FWP-20B	–	A70QS20-14F	A70P20-4
	014	14	11.4	FWP-30A14F		FWP-30B	–	A70QS32-14F	A70P30-4
	019	19	15.5	FWP-40A14F		FWP-40B	–	A70QS40-14F	A70QS40-4
	027	27	22.1	FWP-63A22F	CH222D	FWP-60B	–	A70QS63-22F	A70QS60-4
	035	35	28.6	FWP-80A22F		FWP-70B	–	A70QS80-22F	A70QS70-4
	045	45	36.8	FWP-100A22F		FWP-90B	–	–	A70QS90-4
	052	52	42.5	FWP-100A22F		FWP-100B	–	–	A70QS100-4
	073	73	59.6	–	–	FWP-150A	BH-1133	–	A70QS150-4K
	086	86	70.3	–	–	FWP-175A		–	A70QS175-4K
	100	100	81.7	–	–	FWP-200A		–	A70QS200-4K
129	129	105.4	–	–	FWP-250A	–		A70QS250-4	
B	167	167	136.4	–	–	FWP-350A		–	A70QS350-4
	207	207	169.1	–	–	FWP-400A	BH-3144	–	A70QS400-4
	250	250	204.3	–	–	FWP-500A		–	A70QS500-4K
	330	330	269.6	–	–	FWP-700A		–	A70QS700-4
	412	412	336.6	–	–	FWP-800A		–	A70QS800-4

Table 41 - 575V AC Input Drives

Frame	Drive Current Rating Code	DC Amps	AC Line Amps	Bussmann		Ferraz Shawmut (Gould Shawmut)
				North American FWP Type	North American FWP Fuse Block	North American A70P / A70QS Type
B	067	67.5	55.1	FWP-125A	BH-1133	A70QS125-4K
	101	101.3	82.7	FWP-200A		A70QS200-4K
	135	135	110.3	FWP-250A		A70QS250-4
	270	270	220.6	FWP-600A	BH-3144	A70QS600-4K
	405	405	330.9	FWP-800A		A70QS800-4

Frame A and B Recommended Field Circuit Fuses

Field circuit fuses are internally mounted and provided with the drive. See Fuse Code FS3 in Frame A and B Fuse Designations on page 139. Also, see Frame A Field AC Input Line Fuses Location on page 145 and Frame B Field AC Input Line Fuses Location on page 146 for fuse locations.

Table 42 - 230V AC Input Drives

Frame	Drive Current Rating Code	Field Amps	Type	Quantity	Bussmann	Ferraz Shawmut (Gould Shawmut)	SIBA
A	7P0	10	6 x 32 mm	2	FWH-016A6F	E085449	70 125 40.16
	9P0						
	012						
	020						
	029						
	038						
	055						
	073	14					
	093						
	110						
B	146	20	10 x 38 mm	2	FWC-25A10F	A60Q25-2	60 033 05.25
	180						
	218						
	265						
	360						
	434						

Table 43 - 460V AC Input Drives

Frame	Drive Current Rating Code	Field Amps	Type	Quantity	Bussmann	Ferraz Shawmut (Gould Shawmut)	SIBA
A	4P1	10	6 x 32 mm	2	FWH-016A6F	E085449	70 125 40.16
	6P0						
	010						
	014						
	019						
	027						
	035						
	045						
	052						
	073						
	086						
	100						
	129						

Frame	Drive Current Rating Code	Field Amps	Type	Quantity	Bussmann	Ferraz Shawmut (Gould Shawmut)	SIBA
B	167	20	10 x 38 mm	2	FWC-25A10F	A60Q25-2	60 033 05.25
	207						
	250						
	330						
	412						

Table 44 - 575V AC Input Drives

Frame	Drive Current Rating Code	Field Amps	Quantity	Type	Bussmann	Ferraz Shawmut (Gould Shawmut)	SIBA
B	067	20	2	10 x 38 mm	FWC-25A10F	A60Q25-2	60 033 05.25
	101						
	135						
	270						
	405						

Figure 101 - Frame A Field AC Input Line Fuses Location

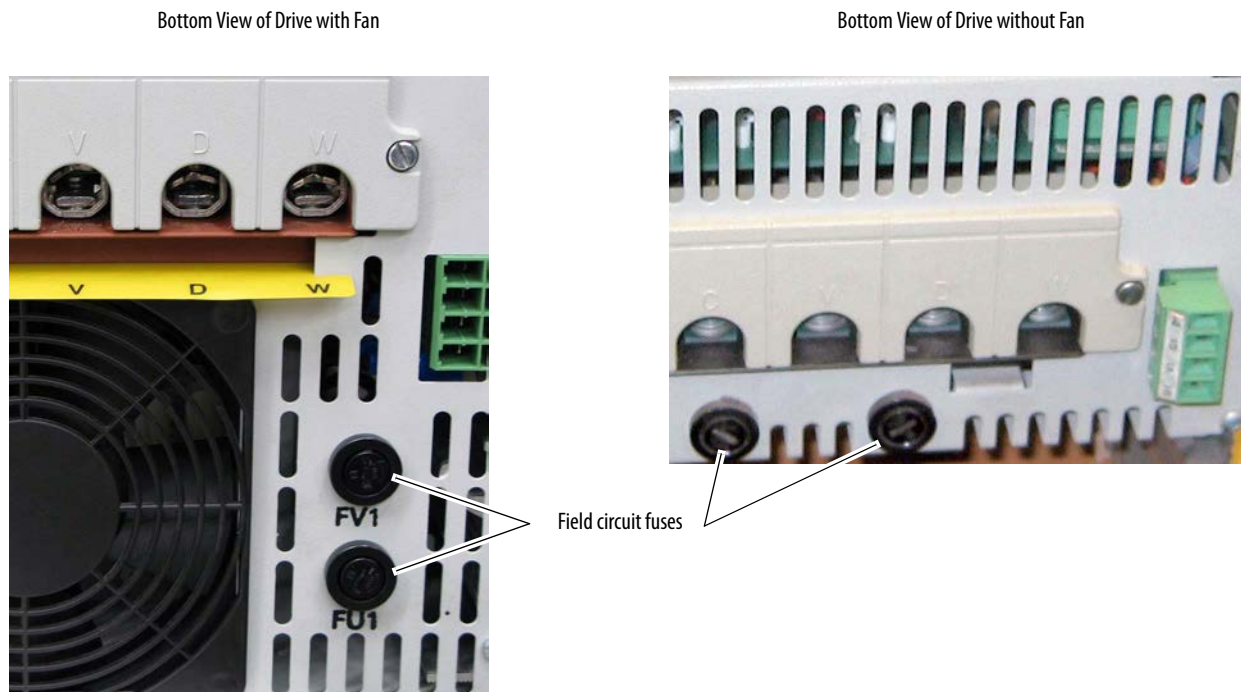
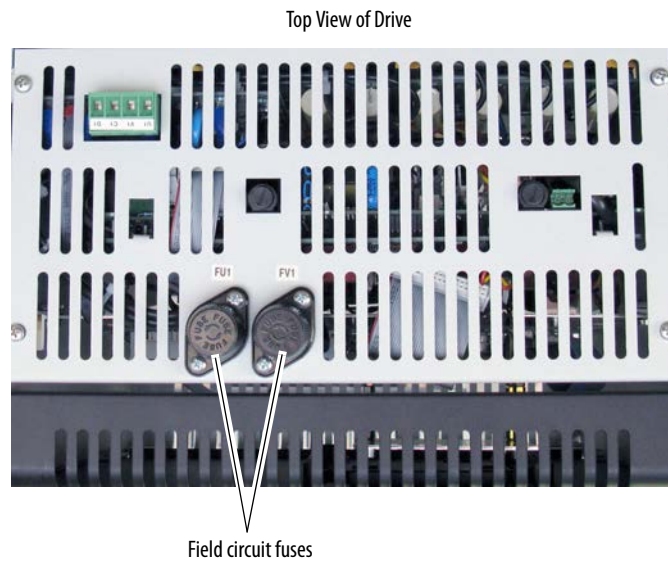
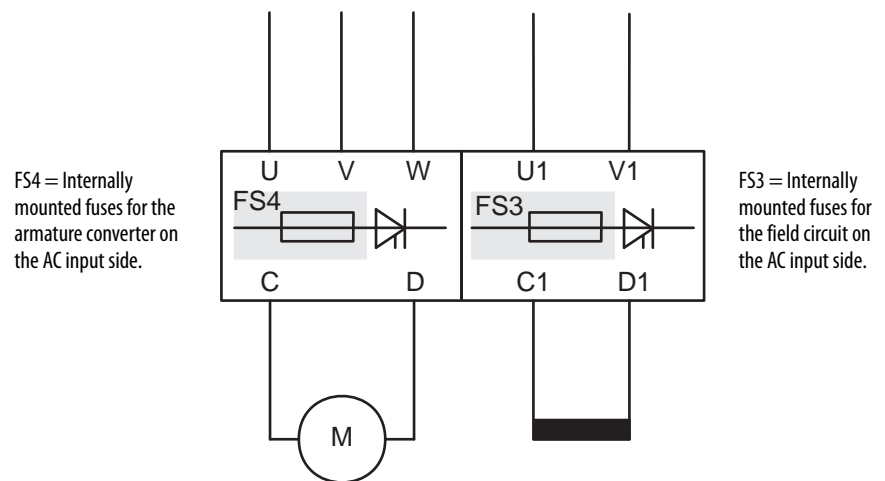


Figure 102 - Frame B Field AC Input Line Fuses Location



Frame C and D Fuse Designations

All fuses for armature and field circuit protection are internally mounted and provided with frame C and D drives.



Frame C and D Recommended Field Circuit Fuses

Field circuit fuses for frames C and D drives are internally mounted (labeled FU1 and FV1) and provided with the drive. See Fuse Code FS3 in Frame C and D Fuse Designations on page 146. Also, see Frame C Field Circuit Fuse Location on page 148 and Frame D Field Circuit Fuse Location on page 149 for locations.

Table 45 - 230V AC Input Drives

Frame	Drive Current Rating Code	Field Amps	Type	Qty	Bussmann	Ferraz Shawmut (Gould Shawmut)	SIBA
C	521	20	10 x 38 mm	2	FWC-25A10F	A60Q25-2	6003305.25
D	875	40	22 x 58 mm		FWP-50A22F	A70QS50-22F	5014006.50
	1K0						

Table 46 - 460V AC Input Drives

Frame	Drive Current Rating Code	Field Amps	Type	Qty	Bussmann	Ferraz Shawmut (Gould Shawmut)	SIBA
C	495	20	10 x 38 mm	2	FWC-25A10F	A60Q25-2	6003305.25
	667					A60Q25-8	
D	830	40	22 x 58 mm		FWP-50A22F	A70QS50-22F	5014006.50
	996						
	1K1	70			FWP-100A22F	A70QS100-22F	5014006.100
	1K3						
	1K4						

Table 47 - 575V AC Input Drives

Frame	Drive Current Rating Code	Field Amps	Type	Qty	Bussmann	Ferraz Shawmut (Gould Shawmut)	SIBA
C	540	20	10 x 38 mm	2	FWC-25A10F	A60Q25-2	6003305.25
	675					A60Q25-8	
D	810	40	22 x 58 mm		FWP-50A22F	A70QS50-22F	5014006.50
	1K0						
	1K2						
	1K3						
	1K6						

Table 48 - 690V AC Input Drives

Frame	Drive Current Rating Code	Field Amps	Type	Qty	Bussmann	Ferraz Shawmut (Gould Shawmut)	SIBA
C	452	20	10 x 38 mm	2	FWC-25A10F	A60Q25-2	6003305.25
	565					A60Q25-8	
D	678	40	22 x 58 mm		FWP-50A22F	A70QS50-22F	5014006.50
	791					A70QS100-22F	
	904						
	1K0						
	1K1	70			FWP-100A22F	A70QS100-22F	5014006.100
	1K2						
	1K4						
	1K5						

Figure 103 - Frame C Field Circuit Fuse Location

Field AC input fuses are located on the Control EMI shield, which holds the Control board.

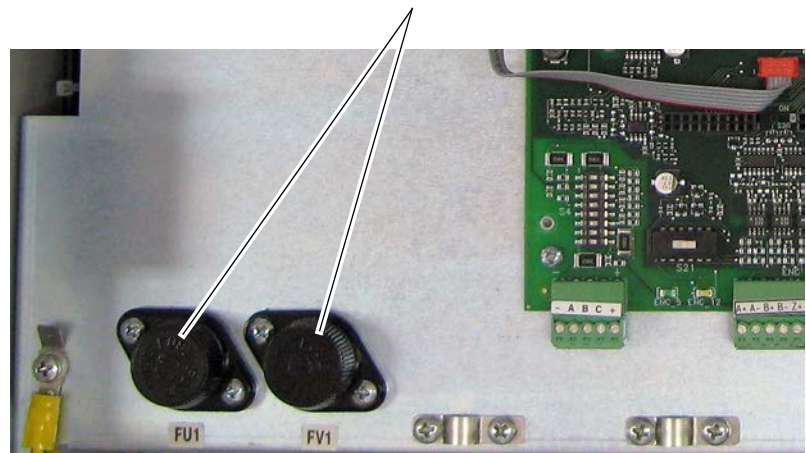
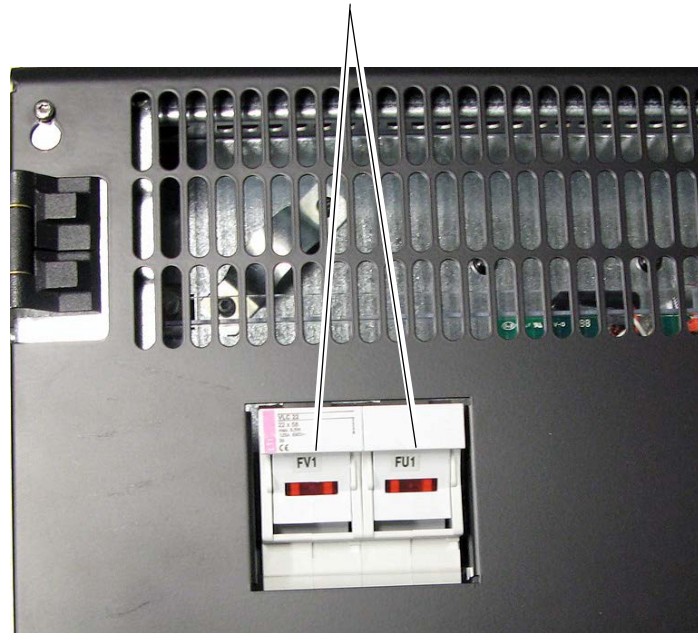


Figure 104 - Frame D Field Circuit Fuse Location

Top, left side of drive control panel.



Fuses for Regenerative Frame C and D Drives

Leg fuses are internally mounted and provided with frames C and D drives. See Fuse Code FS4 in Frame C and D Fuse Designations on page 146. Also, see Frame C Regenerative Drive - Leg Fuse Location on page 151 and Frame D Regenerative Drive - Leg Fuse Location on page 151.

Table 49 - Recommended Leg Fuses - 230V AC Input Frame C Drives

Frame	Drive Current Rating Code	DC Amps	AC Line Amps	Qty	Bussmann	Ferraz Shawmut (Gould Shawmut)	SIBA
					Square Body - Flush End Contact		
C	521	521	426	6	170M5464 + switch 170H0069	6,9 URD 32 TTF 800 + switch MS 3-V1-5 BS	20 671 32.800 + switch 28 001 04
	700	700	571	6	170M5464 + switch 170H0069	6,9 URD 32 TTF 800 + switch MS 3V 1-5 BS	20 671 32.800 + switch 28 001 04

Table 50 - Recommended Leg Fuses - 230V AC Input Frame D Drives

Frame	Drive Current Rating Code	DC Amps	AC Line Amps	Qty	Bussmann	Ferraz Shawmut (Gould Shawmut)	SIBA
					Square Body - DIN 43653 Stud-Mount		
D	875	875	715	6	170M6263 + switch 170H0069	Y300263 + switch MS 3V 1-5 UR	20 635 32.900 + switch 28 001 04
	1K0	1050	858	6	170M6264 + switch 170H0069	Z300264 + switch MS 3V 1-5 UR	20 635 32.1000 + switch 28 001 04

Table 51 - Recommended Leg Fuses - 460V AC Input Frame C Drives

Frame	Drive Current Rating Code	DC Amps	AC Line Amps	Qty	Bussmann	Ferraz Shawmut (Gould Shawmut)	SIBA
					Square Body - Flush End Contact		
C	495	495	404.4	6	170M5462 + switch 170H0069	6,9 URD 32 TTF 630 + switch MS 3-V1-5 BS	20 671 32.630 + switch 28 001 04
	667	667	544.9	6	170M5464 + switch 170H0069	6,9 URD 32 TTF 800 + switch MS 3-V1-5 BS	20 671 32.800 + switch 28 001 04

Table 52 - Recommended Leg Fuses - 460V AC Input Frame D Drives

Frame	Drive Current Rating Code	DC Amps	AC Line Amps	Qty	Bussmann	Ferraz Shawmut (Gould Shawmut)	SIBA
					Square Body - DIN 43653 Stud-Mount		
D	830	830	678.1	6	170M6262 + switch 170H0069	X300262 + switch MS 3V 1-5 UR	20 635 32.800 + switch 28 001 04
	996	996	813.7	6	170M6264 + switch 170H0069	Z300264 + switch MS 3V 1-5 UR	20 635 32.1000 + switch 28 001 04
	1K1	1162	949.4	6	170M6265 + switch 170H0069	A300262 + switch MS 3V 1-5 UR	20 635 32.1100 + switch 28 001 04
	1K3	1328	1085.0	6	170M6266 + switch 170H0069	B300266 + switch MS 3V 1-5 UR	20 635 32.1250 + switch 28 001 04
	1K4	1494	1220.6	6	170M6267 + switch 170H0069	C300267 + switch MS 3V 1-5 UR	20 635 32.1400 + switch 28 001 04

Table 53 - Recommended Leg Fuses - 575V AC Input Frame C Drives

Frame	Drive Current Rating Code	DC Amps	AC Line Amps	Qty	Bussmann	Ferraz Shawmut (Gould Shawmut)	SIBA
					Square Body - Flush End Contact		
C	540	540	441	6	–	11 URD 72 TTF 0800 + switch MS 3V 1-5 BS	20 771 32.800 + switch 28 001 04
	675	675	551	6	–	11 URD 72 TTF 0800 + switch MS 3V 1-5 BS	20 771 32.800 + switch 28 001 04

Table 54 - Recommended Leg Fuses - 575V AC Input Frame D Drives

Frame	Drive Current Rating Code	DC Amps	AC Line Amps	Qty	Bussmann	Ferraz Shawmut (Gould Shawmut)	SIBA
					Square Body - DIN 43653 Stud-Mount		
D	810	810	661	6	170M6246 + switch 170H0069	J300572 + switch MS 3V 1-5 UR	20 735 32.800 + switch 28 001 04
	1K0	1080	881	6	170M6248 + switch 170H0069	L300574 + switch MS 3V 1-5 UR	20 735 32.1000 + switch 28 001 04
	1K2	1215	991	12	170M6244 + switch 170H0069	G300570 + switch MS 3V 1-5 UR	20 735 32.630 + switch 28 001 04
	1K3	1350	1102	12	170M6245 + switch 170H0069	H300571 + switch MS 3V 1-5 UR	20 735 32.700 + switch 28 001 04
	1K6	1688	1377	12	170M6246 + switch 170H0069	J300572 + switch MS 3V 1-5 UR	20 735 32.800 + switch 28 001 04

Table 55 - Recommended Leg Fuses - 690V AC Input Frame C Drives

Frame	Drive Current Rating Code	DC Amps	AC Line Amps	Qty	Bussmann	Ferraz Shawmut (Gould Shawmut)	SIBA
					Square Body - Flush End Contact		
C	452	452	369	6	170M5394 + switch 170H0069	12,5 URD 72 TTF 0500 + switch MS 3V 1-5 BS	20 771 32.500 + switch 28 001 04
	565	565	461	6	–	12,5 URD 72 TTF 0630 + switch MS 3V 1-5 BS	20 771 32.630 + switch 28 001 04

Table 56 - Recommended Leg Fuses - 690V AC Input Frame D Drives

Frame	Drive Current Rating Code	DC Amps	AC Line Amps	Qty	Bussmann	Ferraz Shawmut (Gould Shawmut)	SIBA
					Square Body - DIN 43653 Stud-Mount		
D	678	678	553	6	170M6244 + switch 170H0069	G300570 + switch MS 3V 1-5 UR	20 735 32.630 + switch 28 001 04
	791	791	645	6	170M6246 + switch 170H0069	J300572 + switch MS 3V 1-5 UR	20 735 32.800 + switch 28 001 04
	904	904	738	6	170M6247 + switch 170H0069	K300573 + switch MS 3V 1-5 UR	20 735 32.900 + switch 28 001 04
	1K0	1017	830	6	170M6248 + switch 170H0069	L300574 + switch MS 3V 1-5 UR	20 735 32.1000 + switch 28 001 04
	1K1	1130	922	12	170M6244 + switch 170H0069	G300570 + switch MS 3V 1-5 UR	20 735 32.630 + switch 28 001 04
	1K2	1243	1014	12	170M6244 + switch 170H0069	G300570 + switch MS 3V 1-5 UR	20 735 32.630 + switch 28 001 04
	1K4	1413	1153	12	170M6245 + switch 170H0069	H300571 + switch MS 3V 1-5 UR	20 735 32.700 + switch 28 001 04
	1K5	1582	1291	12	170M6246 + switch 170H0069	J300572 + switch MS 3V 1-5 UR	20 735 32.800 + switch 28 001 04

Figure 105 - Frame C Regenerative Drive - Leg Fuse Location

Note: Drive shown with front covers removed and Control EMI shield lowered.

Leg fuses and switches are located on the bus bars behind the Control EMI shield, which holds the Control board.

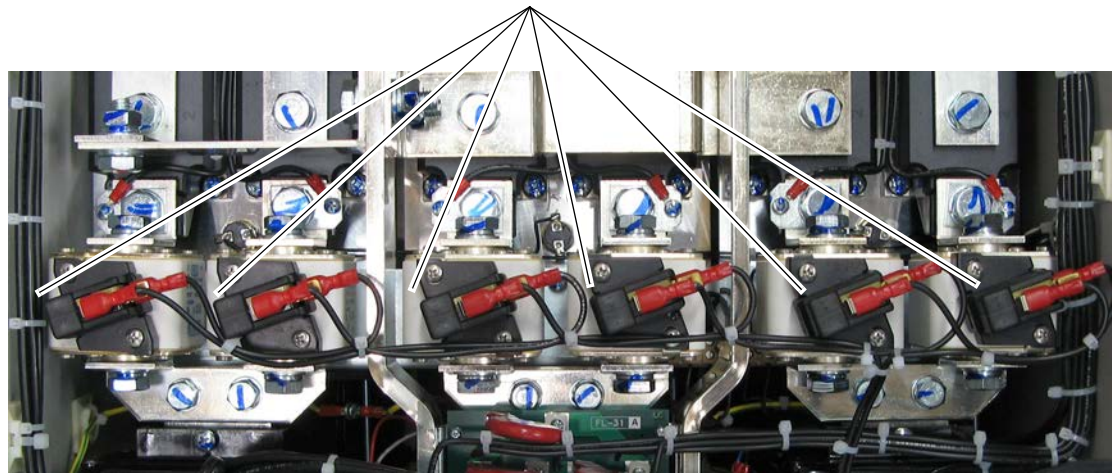
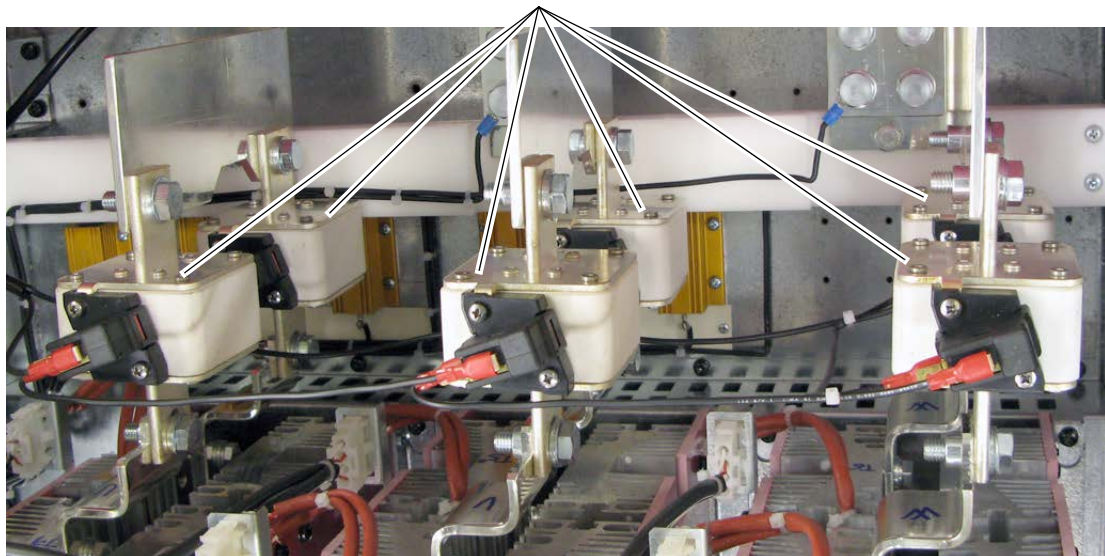


Figure 106 - Frame D Regenerative Drive - Leg Fuse Location

Note: Drive shown with Control EMI shield in open position.

Leg fuses and switches are located on the bus bars behind the Control EMI shield, which holds the Control board.



Fuses for Non-Regenerative Frame C and D Drives

AC input line and/or leg fuses are internally mounted and provided with frames C and D drives. See Fuse Code FS4 in Frame C and D Fuse Designations on page 146. Also, see Frame C Non-Regenerative Drive - AC Input Line Fuse Location on page 153.

Table 57 - Recommended AC Input Line Fuses - 230V AC Input Frame C

Frame	Drive Current Rating Code	DC Amps	AC Line Amps	Qty	Bussmann	Ferraz Shawmut (Gould Shawmut)	SIBA
					Square Body - Flush End Contact		
C	521	521	426	3	170M5466 + switch 170H0069	6,9 URD 32 TTF 1000 + switch MS 3-V1-5 BS	20 671 32.1000 + switch 28 001 04
	700	700	571	3	170M5466 + switch 170H0069	6,9 URD 32 TTF 1000 + switch MS 3V 1-5 BS	20 671 32.1000 + switch 28 001 04

Table 58 - Recommended Leg Fuses - 230V AC Input Frame D Drives

Frame	Drive Current Rating Code	DC Amps	AC Line Amps	Qty	Bussmann	Ferraz Shawmut (Gould Shawmut)	SIBA
					Square Body - DIN 43653 Stud-Mount		
D	875	875	715	6	170M6263 + switch 170H0069	Y300263 + switch MS 3V 1-5 UR	20 635 32.900 + switch 28 001 04
	1K0	1050	858	6	170M6264 + switch 170H0069	Z300264 + switch MS 3V 1-5 UR	20 635 32.1000 + switch 28 001 04

Table 59 - Recommended AC Input Line Fuses - 460V AC Input Frame C

Frame	Drive Current Rating Code	DC Amps	AC Line Amps	Qty	Bussmann	Ferraz Shawmut (Gould Shawmut)	SIBA
					Square Body - Flush End Contact		
C	495	495	404.4	3	170M5464 + switch 170H0069	6,9 URD 32 TTF 800 + switch MS 3-V1-5 BS	20 671 32.800 + switch 28 001 04
	667	667	544.9	3	170M5466 + switch 170H0069	6,9 URD 32 TTF 1000 + switch MS 3-V1-5 BS	20 671 32.1000 + switch 28 001 04

Table 60 - Recommended Leg Fuses - 460V AC Input Frame D Drives

Frame	Drive Current Rating Code	DC Amps	AC Line Amps	Qty	Bussmann	Ferraz Shawmut (Gould Shawmut)	SIBA
					Square Body - DIN 43653 Stud-Mount		
D	830	830	678.1	6	170M6262 + switch 170H0069	X300262 + switch MS 3V 1-5 UR	20 635 32.800 + switch 28 001 04
	996	996	813.7	6	170M6264 + switch 170H0069	Z300264 + switch MS 3V 1-5 UR	20 635 32.1000 + switch 28 001 04
	1K1	1162	949.4	6	170M6265 + switch 170H0069	A300262 + switch MS 3V 1-5 UR	20 635 32.1100 + switch 28 001 04
	1K3	1328	1085.0	6	170M6266 + switch 170H0069	B300266 + switch MS 3V 1-5 UR	20 635 32.1250 + switch 28 001 04
	1K4	1494	1220.6	6	170M6267 + switch 170H0069	C300267 + switch MS 3V 1-5 UR	20 635 32.1400 + switch 28 001 04

Table 61 - Recommended AC Input Line Fuses - 575V AC Input Frame C Drives

Frame	Drive Current Rating Code	DC Amps	AC Line Amps	Qty	Bussmann	Ferraz Shawmut (Gould Shawmut)	SIBA
					Square Body - Flush End Contact		
C	540	540	441	3	170M5466 + switch 170H0069	6,9 URD 32 TTF 1000 + switch MS 3V 1-5 BS	20 671 32.1000 + switch 28 001 04
	675	675	551	3	170M5466 + switch 170H0069	6,9 URD 32 TTF 1000 + switch MS 3V 1-5 BS	20 671 32.1000 + switch 28 001 04

Table 62 - Recommended Leg Fuses - 575V AC Input Frame D Drives

Frame	Drive Current Rating Code	DC Amps	AC Line Amps	Qty	Bussmann	Ferraz Shawmut (Gould Shawmut)	SIBA
					Square Body - DIN 43653 Stud-Mount		
D	810	810	661	6	170M6262 + switch 170H0069	X300262 + switch MS 3V 1-5 UR	20 635 32.800 + switch 28 001 04
	1K0	1080	881	6	170M6264 + switch 170H0069	Z300264 + switch MS 3V 1-5 UR	20 635 32.1000 + switch 28 001 04
	1K2	1215	991	6	170M6265 + switch 170H0069	A300262 + switch MS 3V 1-5 UR	20 635 32.1100 + switch 28 001 04
	1K3	1350	1102	6	170M6266 + switch 170H0069	B300266 + switch MS 3V 1-5 UR	20 635 32.1250 + switch 28 001 04
	1K6	1688	1377	12	170M6262 + switch 170H0069	X300262 + switch MS 3V 1-5 UR	20 635 32.800 + switch 28 001 04

Table 63 - Recommended AC Input Line Fuses - 690V AC Input Frame C Drives

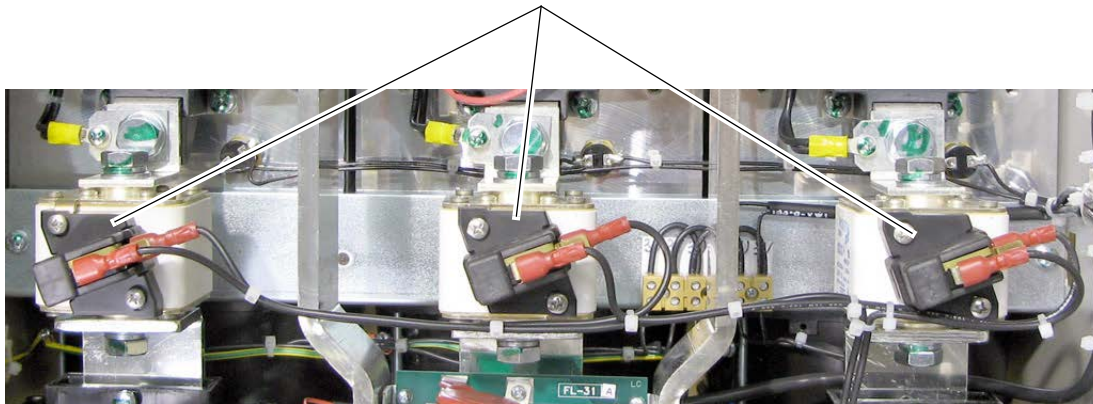
Frame	Drive Current Rating Code	DC Amps	AC Line Amps	Qty	Bussmann	Ferraz Shawmut (Gould Shawmut)	SIBA
					Square Body - Flush End Contact		
C	452	452	369	6	170M5463 + switch 170H0069	6,9 URD 32 TTF 0700 + switch MS 3V 1-5 BS	20 671 32.700 + switch 28 001 04
	565	565	461	6	170M5465 + switch 170H0069	6,9 URD 32 TTF 0900 + switch MS 3V 1-5 BS	20 671 32.900 + switch 28 001 04

Table 64 - Recommended Leg Fuses - 690V AC Input Frame D Drives

Frame	Drive Current Rating Code	DC Amps	AC Line Amps	Qty	Bussmann	Ferraz Shawmut (Gould Shawmut)	SIBA
					Square Body - DIN 43653 Stud-Mount		
D	678	678	553	6	170M6260 + switch 170H0069	V300260 + switch MS 3V 1-5 UR	20 635 32.630 + switch 28 001 04
	791	791	645	6	170M6262 + switch 170H0069	X300262 + switch MS 3V 1-5 UR	20 635 32.800 + switch 28 001 04
	904	904	738	6	170M6263 + switch 170H0069	Y300263 + switch MS 3V 1-5 UR	20 635 32.900 + switch 28 001 04
	1K0	1017	830	6	170M6264 + switch 170H0069	Z300264 + switch MS 3V 1-5 UR	20 635 32.1000 + switch 28 001 04
	1K1	1130	922	6	170M6265 + switch 170H0069	A300262 + switch MS 3V 1-5 UR	20 635 32.1100 + switch 28 001 04
	1K2	1243	1014	6	170M6266 + switch 170H0069	B300266 + switch MS 3V 1-5 UR	20 635 32.1250 + switch 28 001 04
	1K4	1413	1153	6	170M6267 + switch 170H0069	C300267 + switch MS 3V 1-5 UR	20 635 32.1400 + switch 28 001 04
	1K5	1582	1291	12	170M6262 + switch 170H0069	X300262 + switch MS 3V 1-5 UR	20 635 32.800 + switch 28 001 04

Figure 107 - Frame C Non-Regenerative Drive - AC Input Line Fuse Location

AC Input fuses and switches are located on the bus bars behind the Control EMI shield, which holds the Control board.



Note: Drive shown with front covers removed and Control EMI shield lowered.

Control Power

The following fuses are used to protect the Switching Power Supply circuit.

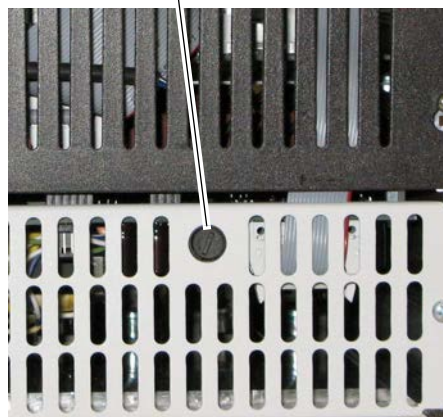
IMPORTANT Verify the circuit board revision prior to ordering and installing fuses.

Table 65 - Control Power Fuses

Frame	Circuit Board ID / Revision	Designation	Fuse (5 x 20 mm)
A	SW1-31 / H & below	F1	1 A, 250V, slow
	SW1-31 / I & above	F1	2.5 A, 250V, slow
B	SW2-32 / H & below	F1	3.15 A, 250V fast
		F2	2.5 A, 250V slow
	SW2-32 / I & above	F1	2.5 A, 250V slow
		F2	
C	SW3-32 / H & below	F1	3.15 A, 250V fast
		F2	2.5 A, 250V slow
	SW3-32 / I & above	F1	2.5 A, 250V slow
		F2	
D	SW1-31 / I & above	F1	2.5 A, 250V, slow

Figure 108 - Frame A Switching Power Supply Fuse Location

Switching Power Supply fuse



Top View of Drive

Figure 109 - Frame B Switching Power Supply Fuse Location

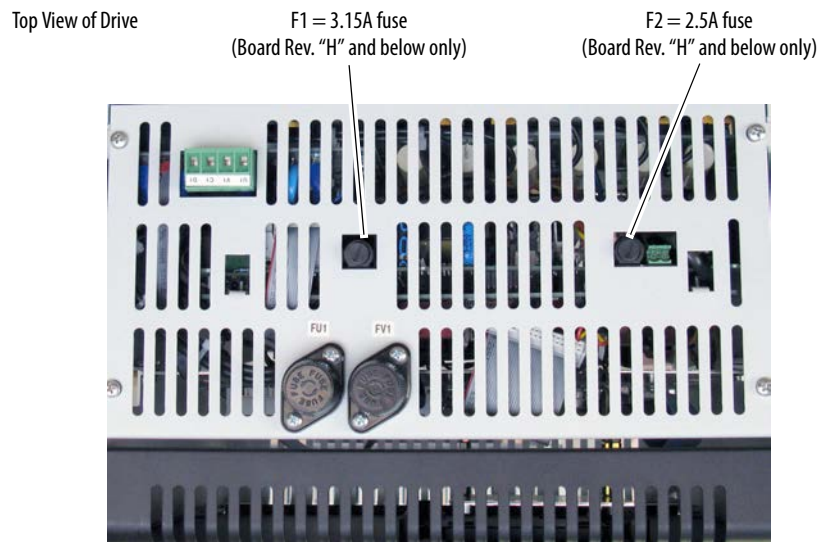
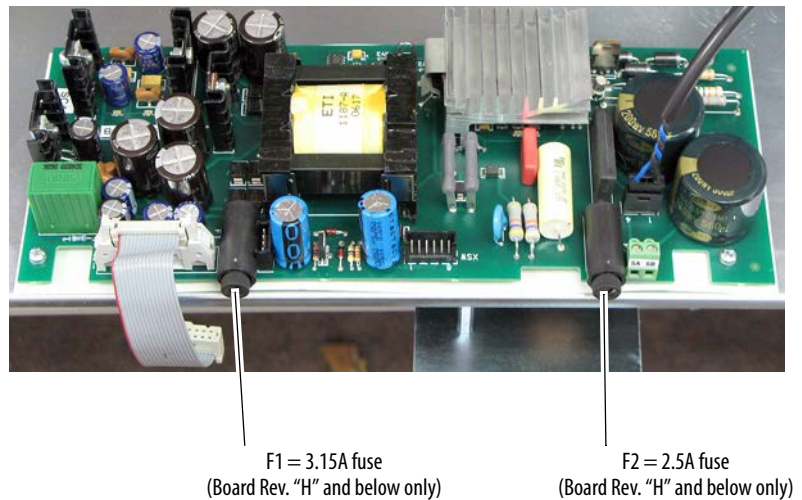
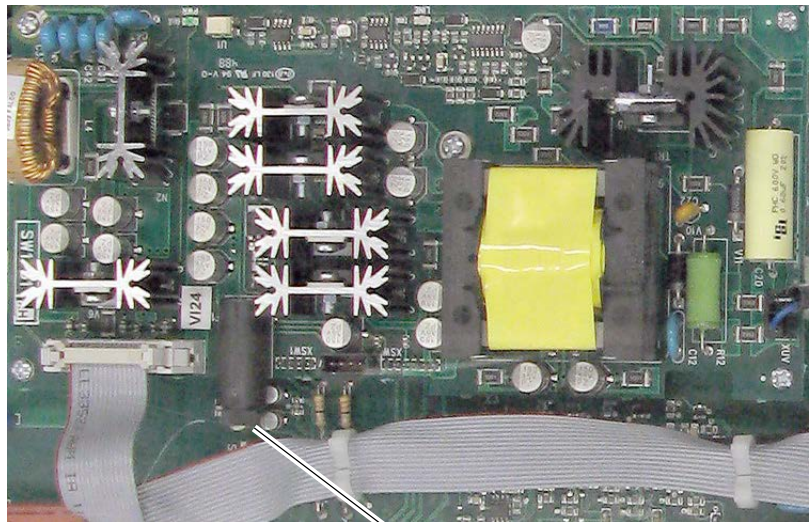


Figure 110 - Frame C Switching Power Supply Fuse Location



Fuses are located on the Switching Power Supply circuit board (SW-2) on the back of the Control EMI shield, which holds the Control board.

Figure 111 - Frame D Switching Power Supply Circuit Board Fuse Location



Switching Power Supply fuse holder

The Switching Power Supply circuit board is located on the Control EMI shield.

PowerFlex DC Drive Accessories

Dynamic Brake Resistor Kits and DC Output Contactors

See Alternate Dynamic Brake Resistor Kits and DC Output Contactors on page [159](#) for recommended alternate DC Output Contactors for 575V and 690V AC input drives, respectively.

Table 66 - 230V AC Input Drives

Frame	Drive Current Rating Code	DC Amps	AC Line Amps	Hp	Dynamic Brake Resistor Kit Cat. No.	Armature Voltage (Volts)	DB Resistor Size (ohms)	DB Resistor Size (Watts)	Brake Amps Required	DC Loop Contactor Cat. No. ⁽³⁾	DC Contactor Crimp Lugs Cat. No. ⁽⁴⁾
A	7P0	7	5.7	1.5	1370-DBL62	240	20	420	12.00	1370-DC56	1370-LG40
	9P0	9	7.4	2	1370-DBL63	240	20	420	12.00	1370-DC56	1370-LG40
	012	12	9.8	3	1370-DBL64	240	15	420	16.00	1370-DC56	1370-LG40
	020	20	16	5	1370-DBL65	240	8.6	420	27.91	1370-DC56	1370-LG40
	029	29	24	7.5	1370-DBL66	240	6	345	40.00	1370-DC56	1370-LG40
	038	38	31	10	1370-DBL67	240	5	330	48.00	1370-DC56	1370-LG40
	055	55	45	15	1370-DBL68	240	3.5	385	68.57	1370-DC56	1370-LG56
	073	73	60	20	1370-DBL69	240	2.6	385	92.31	1370-DC110	1370-LG92
	093	93	76	25	1370-DBL70	240	2	330	120.00	1370-DC110	1370-LG92
	110	110	90	30	1370-DBL71	240	2	330	120.00	1370-DC110	1370-LG110
B	146	146	119	40	1370-DBL72	240	0.7	280	342.86	1370-DC180	1370-LG160
	180	180	147	50	1370-DBL73	240	0.5	365	480.00	1370-DC180	1370-LG180
	218	218	178	60	1370-DBL74	240	0.5	365	480.00	1370-DC280	1370-LG228
	265	265	217	75	1370-DBL75	240	2	330	120.00	1370-DC280	1370-LG268
	360	360	294	100	1370-DBL76	240	1.4	290	171.43	(1)	(5)
	434	434	355	125	(1)	240	0.5	1458	651	(1)	(5)
C	521	521	426	150	(1)	240	0.322	6221	781	(1)	(5)
	700	700	572	200	(2)	240	–	–	–	(1)	(5)
D	875	875	715	250	(2)	240	–	–	–	(1)	(5)
	1K0	1050	858	300	(2)	240	–	–	–	(1)	(5)

(1) See Alternate Dynamic Brake Resistor Kits and DC Output Contactors on page [159](#).

(2) No Dynamic Brake Resistor kit available for this drive rating - must be sourced locally.

(3) Coil voltage = 115V AC, 50/60 Hz.

(4) See DC Contactor Crimp Lug Kit Specifications on page [159](#) for more information.

(5) Wire and Lug size dependant on enclosure dimensions and local codes.

Table 67 - 460V AC Input Drives

Frame	Drive Current Rating Code	DC Amps	AC Line Amps	Hp	Dynamic Brake Resistor Kit Cat. No.	Armature Voltage (Volts)	DB Resistor Size (ohms)	DB Resistor Size (Watts)	Brake Amps Required	DC Loop Contactor Cat. No. ⁽³⁾	DC Contactor Crimp Lugs Cat. No. ⁽⁴⁾
A	4P1	4.1	3.3	2	1370-DBH63	500	81	255	6.17	1370-DC56	1370-LG40
	6P0	6	4.9	3	1370-DBH64	500	62	245	8.06	1370-DC56	1370-LG40
	010	10	8.2	5	1370-DBH65	500	45	245	11.11	1370-DC56	1370-LG40
	014	14	11.4	7.5	1370-DBH66	500	27	350	18.52	1370-DC56	1370-LG40
	019	19	15.5	10	1370-DBH67	500	20	420	25.00	1370-DC56	1370-LG40
	027	27	22.1	15	1370-DBH68	500	12	405	41.67	1370-DC56	1370-LG40
	035	35	28.6	20	1370-DBH69	500	5	330	100.00	1370-DC56	1370-LG40
	045	45	36.8	25	1370-DBH70	500	4.5	330	111.11	1370-DC56	1370-LG52
	052	52	42.5	30	1370-DBH71	500	3.5	385	142.86	1370-DC56	1370-LG52
	073	73	59.6	40	1370-DBH72	500	2.6	345	192.31	1370-DC110	1370-LG92
	086	86	70.3	50	1370-DBH73	500	2	345	250.00	1370-DC110	1370-LG92
	100	100	81.7	60	1370-DBH74	500	2	345	250.00	1370-DC110	1370-LG110
	129	129	105.4	75	1370-DBH75	500	1	270	500.00	1370-DC180	1370-LG140
B	167	167	136.4	100	1370-DBH76	500	0.7	280	714.29	1370-DC180	1370-LG180
	207	207	169.1	125	1370-DBH77	500	0.7	280	714.29	1370-DC280	1370-LG228
	250	250	204.3	150	1370-DBH78	500	0.5	365	1000.00	1370-DC280	1370-LG268
	330	330	269.6	200	1370-DBH79	500	0.7	280	714.29	(1)	(5)
	412	412	336.6	250	(1)	500	0.808	7292	–	(1)	(5)
C	495	495	404.4	300	(1)	500	0.595	6069	–	(1)	(5)
	667	667	544.9	400	(1)	500	0.542	6439	–	(1)	(5)
D	800	830	678.1	500	(2)	500	0.463	6338	–	(1)	(5)
	960	996	813.7	600	(2)	500	0.322	6221	–	(1)	(5)
	1K1	1162	949.4	700	(2)	500	0.322	6221	–	(1)	(5)
	1K3	1328	1085.0	800	(2)	500	0.255	5718	–	(1)	(5)
	1K4	1494	1220.6	900	(2)	500	0.255	5718	–	(1)	(5)

(1) See Alternate Dynamic Brake Resistor Kits and DC Output Contactors on page 159.

(2) No Dynamic Brake Resistor kit available for this drive rating - must be sourced locally.

(3) Coil voltage = 115V AC, 50/60 Hz.

(4) See DC Contactor Crimp Lug Kit Specifications on page 159 for more information.

(5) Wire and Lug size dependant on enclosure dimensions and local codes.

DC Contactor Crimp Lug Kit Specifications

Use the information provided in the table below to assist you in ordering the correct Lug kit for your application.

Rated Motor Armature Current ⁽¹⁾ A DC	DC Contactor Rating A DC	Armature Conductor Size ⁽²⁾ AWG	DB Conductor Size ⁽³⁾ AWG	Armature Conductor Crimp Lug Hole Size	DB Conductor Crimp Lug Hole Size	Lug Kit Catalog Number
4.1...35	56	8	8	#10	#10	1370-LG40
45...52	56	6	8	#10	#10	1370-LG52
55	56	4	8	#10	#10	1370-LG56
60...86	110	2	6	0.25 in.	0.25 in.	1370-LG92
100...110	110	1/0	4	0.25 in.	0.25 in.	1370-LG110
129	180	2/0	2	0.3125 in.	0.3125 in.	1370-LG140
146	180	3/0	2	0.3125 in.	0.3125 in.	1370-LG160
147...167	180	4/0	2	0.3125 in.	0.3125 in.	1370-LG180
207...218	280	300MCM	1/0	0.5 in.	0.375 in.	1370-LG228
250...265	280	400MCM	2/0	0.5 in.	0.375 in.	1370-LG268
266...280	280	500MCM	3/0	0.5 in.	0.375 in.	1370-LG280

- (1) The Rated Motor Armature Current is taken directly from the motor nameplate or motor data. The current listed in this column is the maximum current allowed for the Armature Conductor Size (column 3) and the DC Contactor Rating (column 2).
- (2) The armature conductors are sized by multiplying the Rated Motor Armature Current by 1.25 as provided for in NEC 420-22 (1987). The DC lug ratings are determined from NEC Table 310-16 (1987) for copper conductors, insulation temperature rated at 75 °C (167 °F) at an ambient temperature of 30 °C (86 °F). If conditions are other than shown in NEC Table 310-16, then refer to application codes.
- (3) The dynamic braking (DB) conductors are sized as in footnote 2 above, but at half ampacity due to the short time duration of current flow in these conductors, and has been sized to satisfy NEMA Standard ICS 3-302.62 - Dynamic Braking. If the load inertia is larger than that of the motor, calculations must be made to determine correct conductor sizing and DB resistor wattage per NEMA Standard ICS 3-302.62.

Alternate Dynamic Brake Resistor Kits and DC Output Contactors

The following alternate dynamic brake resistor kits and/or DC output contactors may be used with the corresponding PowerFlex DC drives but must be sourced separately from the drive.

Table 68 - 230V AC Input Drives

Frame	Drive Current Rating Code	DC Amps	AC Line Amps	Hp	Dynamic Brake Resistor Kit Cat. No.	Armature Voltage (Volts)	DB Resistor Size (ohms)	DB Resistor Size (Watts)	Brake Amps Required	DC Loop Contactor Cat. No. ⁽²⁾		DC Contactor Crimp Lugs Cat. No. ⁽³⁾
										Drive w/No Dynamic Brake	Drive w Dynamic Brake	
B	360	360	294	100	1370-DBL76	240	1.4	290	171.43	ABB_EHDB360C2P-1L2S	ABB_EHDB360C-1L22SS	⁽⁴⁾
	434	434	355	125	CUTLER-HAMMER_G3AP50 (Qty 4 - two in series, two in parallel)	240	0.5	1458	651	ABB_EHDB520C2P-1L2S	ABB_EHDB520C-1L22SS	
C	521	521	426	150	HUBBELL_Y139W322GB	240	0.322	6221	781			
	700	700	572	200	⁽¹⁾	240	-	-	-	ABB_EHDB800C2P-1L2S	ABB_EHDB800C-1L22SS	
D	875	875	715	250		240	-	-	-	ABB_EHDB960C2P-1L2S	ABB_EHDB960C-1L22SS	
	1K0	1050	858	300		240	-	-	-	SIEMENS-MFG_14-193-101-58-2 (Qty 2)	SIEMENS-MFG_14-193-101-58-2 (Qty 1)	

- (1) No Dynamic Brake Resistor kit available for this drive rating - must be sourced locally.
- (2) Coil voltage = 115V AC, 50/60 Hz.
- (3) See DC Contactor Crimp Lug Kit Specifications on page 159 for more information.
- (4) Wire and Lug size dependant on enclosure dimensions and local codes.

Table 69 - 460V AC Input Drives

Frame	Drive Current Rating Code	DC Amps	AC Line Amps	Hp	Dynamic Brake Resistor Kit Cat. No.	Armature Voltage (Volts)	DB Resistor Size (ohms)	DB Resistor Size (Watts)	Brake Amps Required	DC Loop Contactor Cat. No. ⁽²⁾		DC Contactor Crimp Lugs Cat. No. ⁽³⁾
										Drive w/No Dynamic Brake	Drive w Dynamic Brake	
B	330	330	269.6	200	1370-DBH79	500	0.7	280	714.29	ABB_EHDB360C2P-1L2S	ABB_EHDB360C-1L22SS	(4)
	412	412	336.6	250	HUBBELL_Y95W808GB	500	0.808	7292	–	ABB_EHDB520C2P-1L2S	ABB_EHDB520C-1L22SS	
C	495	495	404.4	300	HUBBELL_Y101W595GB	500	0.595	6069	–	ABB_EHDB520C2P-1L2S	ABB_EHDB520C-1L22SS	
	667	667	544.9	400	HUBBELL_Y109W542GB	500	0.542	6439	–	ABB_EHDB800C2P-1L2S	ABB_EHDB800C-1L22SS	
D	800	830	678.1	500	(1)	500	0.463	6338	–	ABB_EHDB960C2P-1L2S	ABB_EHDB960C-1L22SS	
	960	996	813.7	600		500	0.322	6221	–	SIEMENS-MFG_14-193-101-58-2 (Qty 2)	SIEMENS-MFG_14-193-101-58-2 (Qty 1)	
	1K1	1162	949.4	700		500	0.322	6221	–	SIEMENS-MFG_14-193-101-58-2 (Qty 2)	SIEMENS-MFG_14-193-101-58-2 (Qty 1)	
	1K3	1328	1085.0	800		500	0.255	5718	–	CUTLER-HAMMER_6702ED636-2 (Qty 2)	CUTLER-HAMMER_6702ED636-2 (Qty 1)	
	1K4	1494	1220.6	900		500	0.255	5718	–	CUTLER-HAMMER_6702ED636-2 (Qty 2)	CUTLER-HAMMER_6702ED636-2 (Qty 1)	

- (1) No Dynamic Brake Resistor kit available for this drive rating - must be sourced locally.
- (2) Coil voltage = 115V AC, 50/60 Hz.
- (3) See DC Contactor Crimp Lug Kit Specifications on page 159 for more information.
- (4) Wire and Lug size dependant on enclosure dimensions and local codes.

Table 70 - 575V AC Input Drives

Frame	Drive Current Rating Code	DC Amps	AC Line Amps	Hp	Dynamic Brake Resistor Kit Cat. No.	Armature Voltage (Volts)	DB Resistor Size (ohms)	DB Resistor Size (Watts)	Brake Amps Required	DC Loop Contactor Cat. No. ⁽²⁾		DC Contactor Crimp Lugs Cat. No. ⁽³⁾
										Drive w/No Dynamic Brake	Drive w Dynamic Brake	
B	067	67.5	55.1	50	(1)	600	5.93	–	–	ABB_EHDB220C2P-1L2S	ABB_EHDB220C-1L22SS	(4)
	101	101	83	75		600	3.95	–	–	ABB_EHDB220C2P-1L2S	ABB_EHDB220C-1L22SS	
	135	135	110	100		600	2.96	–	–	ABB_EHDB220C2P-1L2S	ABB_EHDB220C-1L22SS	
	270	270	221	200		600	1.48	–	–	ABB_EHDB360C2P-1L2S	ABB_EHDB360C-1L22SS	
	405	405	331	300		600	0.988	–	–	ABB_EHDB520C2P-1L2S	ABB_EHDB520C-1L22SS	
C	540	540	441	400		600	0.741	–	–	ABB_EHDB650C2P-1L2S	ABB_EHDB650C-1L22SS	
	675	675	551	500		600	0.593	–	–	ABB_EHDB800C2P-1L2S	ABB_EHDB800C-1L22SS	
D	810	810	662	600		600	0.494	–	–	ABB_EHDB960C2P-1L2S	ABB_EHDB960C-1L22SS	
	1K0	1080	882	800		600	0.370	–	–	SIEMENS-MFG_14-193-101-58-2 (Qty 2)	SIEMENS-MFG_14-193-101-58-2 (Qty 1)	
	1K2	1215	993	900		600	0.329	–	–	SIEMENS-MFG_14-193-101-58-2 (Qty 2)	SIEMENS-MFG_14-193-101-58-2 (Qty 1)	
	1K3	1350	1103	1000		600	0.296	–	–	CUTLER-HAMMER_6702ED636-2 (Qty 2)	CUTLER-HAMMER_6702ED636-2 (Qty 1)	
	1K6	1688	1379	1250		600	0.237	–	–	CUTLER-HAMMER_6702ED636-2 (Qty 2)	CUTLER-HAMMER_6702ED636-2 (Qty 1)	

- (1) No Dynamic Brake Resistor kit available for this drive rating - must be sourced locally.
- (2) Coil voltage = 115V AC, 50/60 Hz.
- (3) See DC Contactor Crimp Lug Kit Specifications on page 159 for more information.
- (4) Wire and Lug size dependant on enclosure dimensions and local codes.

Table 71 - 690V AC Input Drives

Frame	Drive Current Rating Code	DC Amps	AC Line Amps	Hp	Dynamic Brake Resistor Kit Cat. No.	Armature Voltage (Volts)	DB Resistor Size (ohms)	DB Resistor Size (Watts)	Brake Amps Required	DC Loop Contactor Cat. No. ⁽²⁾		DC Contactor Crimp Lugs Cat. No. ⁽³⁾
										Drive w/No Dynamic Brake	Drive w Dynamic Brake	
C	452	452	369	400	(1)	700	1.03	–	–	SIEMENS-MFG_14-193-101-58-2 (Qty 2)	SIEMENS-MFG_14-193-101-58-2 (Qty 1)	(4)
	565	565	462	500		700	0.826	–	–	SIEMENS-MFG_14-193-101-58-2 (Qty 2)	SIEMENS-MFG_14-193-101-58-2 (Qty 1)	
D	678	678	554	600		700	0.688	–	–	SIEMENS-MFG_14-193-101-58-2 (Qty 2)	SIEMENS-MFG_14-193-101-58-2 (Qty 1)	
	791	791	646	700		700	0.590	–	–	SIEMENS-MFG_14-193-101-58-2 (Qty 2)	SIEMENS-MFG_14-193-101-58-2 (Qty 1)	
	904	904	739	800		700	0.516	–	–	SIEMENS-MFG_14-193-101-58-2 (Qty 2)	SIEMENS-MFG_14-193-101-58-2 (Qty 1)	
	1K0	1017	831	900		700	0.459	–	–	SIEMENS-MFG_14-193-101-58-2 (Qty 2)	SIEMENS-MFG_14-193-101-58-2 (Qty 1)	
	1K1	1130	923	1000		700	0.413	–	–	SIEMENS-MFG_14-193-101-58-2 (Qty 2)	SIEMENS-MFG_14-193-101-58-2 (Qty 1)	
	1K2	1243	1016	1100		700	0.375	–	–	SIEMENS-MFG_14-193-101-58-2 (Qty 2)	SIEMENS-MFG_14-193-101-58-2 (Qty 1)	
	1K4	1413	1154	1250		700	0.330	–	–	CUTLER-HAMMER_6702ED636-2 (Qty 2)	CUTLER-HAMMER_6702ED636-2 (Qty 1)	
	1K5	1582	1292	1400		700	0.295	–	–	CUTLER-HAMMER_6702ED636-2 (Qty 2)	CUTLER-HAMMER_6702ED636-2 (Qty 1)	

- (1) No Dynamic Brake Resistor kit available for this drive rating - must be sourced locally.
- (2) Coil voltage = 115V AC, 50/60 Hz.
- (3) See DC Contactor Crimp Lug Kit Specifications on page 159 for more information.
- (4) Wire and Lug size dependant on enclosure dimensions and local codes.

Frame D Terminal Adapter Kits

The following frame D drives require the listed terminal adapter kits in order to meet UL installation requirements.

Voltage Class	Drive Current Rating Code	U, V, W Terminal Adapter Kit Number	C, D Terminal Adapter Kit Number	
230	1K0	SK-20P-S726171	–	
	460		1K1	–
			1K3	–
			1K4	–
575	1K0		–	
	1K2		–	
	1K3		–	
	1K6		SK-20P-S726173	
690	1K0		–	
	1K1		–	
	1K2	–		
	1K4	–		
	1K5	–		

PowerFlex DC Motor Overload Protection

Thermistors and Thermal Switches

To detect motor overheating and protect the motor from overloading, an external, user-supplied thermistor (PTC) or thermal switch must be connected to terminals 78 and 79. The drive's response to a motor over temperature fault is configured in parameter 365 [OverTemp Flt Cfg]. If a temperature sensor is not used, a 1k ohm resistor must be connected between terminals 78 and 79 (installed at the factory). The instructions for installing a thermal sensor are detailed below.

Thermistors (PTC)

PTC thermistors fitted in the motor can be connected directly to the drive via terminals 78 and 79. In this case the 1k ohm resistor is not required between terminals 78 and 79.

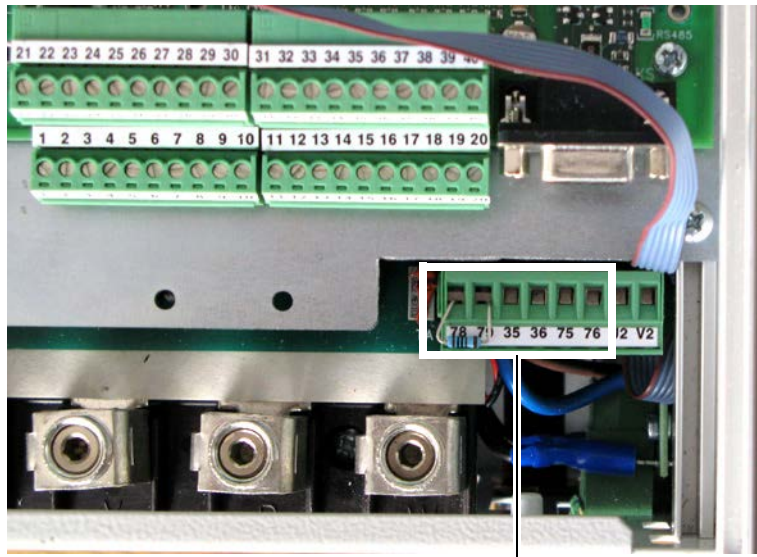
Thermal Switches (Klixon®) in the Motor Windings

“Klixon” type temperature-dependent contacts can disconnect the drive from the motor via an external control or can be configured as an external fault using a digital input on drive. They can also be connected to terminals 78 and 79 in order to indicate a drive “Motor Over Temp” fault (F16), though this is not recommended due to the noise sensitivity of the current threshold circuitry. If a thermal switch is used a 1k ohm resistor must be placed in series between the switch and one of the terminals.

Table 72 - Contact Relay and Thermistor Terminal Designations

Terminal	Description
35	Normally open contact. Configured with parameter 1392 [Relay Out 1 Sel] - set to 25 “Contactor” by default.
36	
75	Normally open contact. Configured with parameter 629 [Relay Out 2 Sel] - set to 5 “Ready” by default.
76	
78	Motor thermistor connections (PTC)
79	

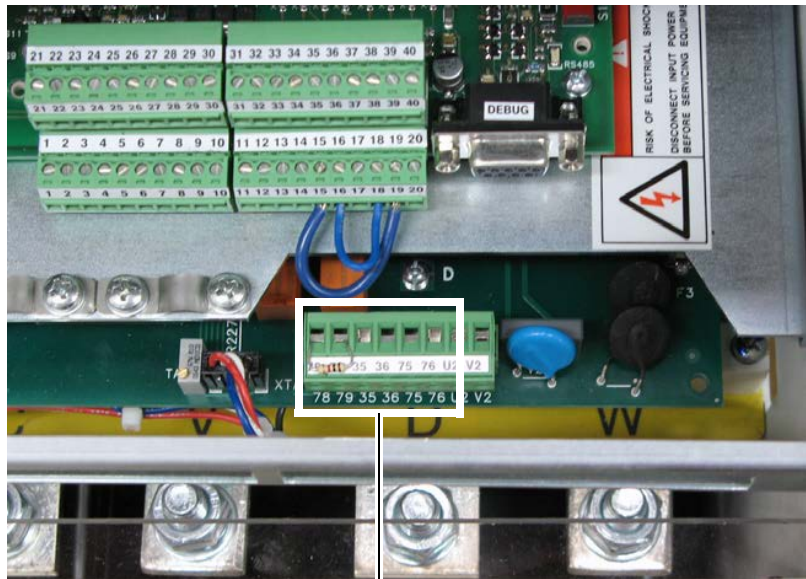
Figure 112 - Frame A Contact Relay and Thermistor Terminal Block Locations



Note: Terminals 78 and 79 shown with 1k ohm resistor in place of temperature sensor.

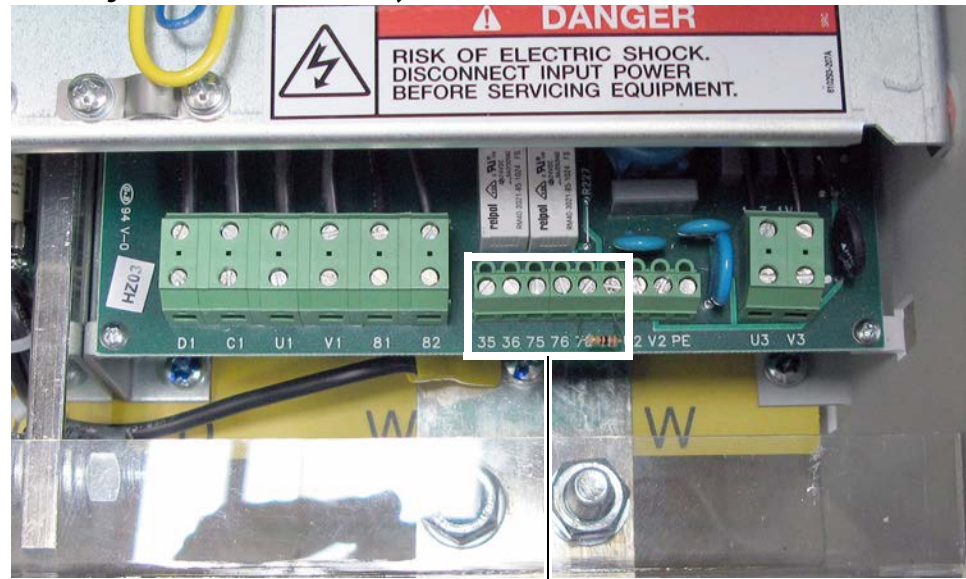
78 79 35 36 75 76

Table 73 - Frame B Contact Relay and Thermistor Terminal Block Locations



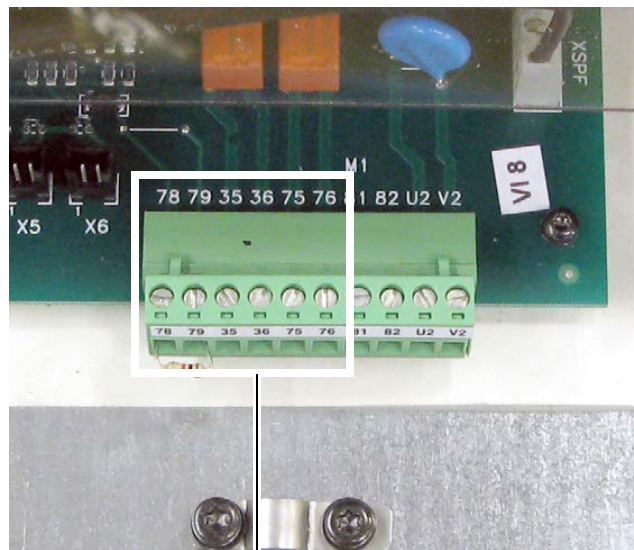
78 79 35 36 75 76

Figure 113 - Frame C Contact Relay and Thermistor Terminal Block Locations



35 36 75 76 78 79

Figure 114 - Frame D Contact Relay and Thermistor Terminal Block Locations



78 79 35 36 75 76

Located on control pan to the left of the HIM cradle.

Table 74 - Recommended Signal Wire Size for Relay Outputs and Thermistor/Thermal Switch Terminals

Signal Type	Terminals	Wire Size and Type ⁽¹⁾			Tightening Torque N•m (lb•in)
		Flexible (mm ²)	Multi-core (mm ²)	AWG	
Relay Outputs	35 & 36, 75 & 76	0.140...1.500	0.140...1.500	26...14	0.5 (4.4)
Thermistor and Thermal Switches	78 & 79				

(1) See "Cable and Wiring Recommendations" in the PowerFlex Digital DC Drive User Manual, publication [20P-UM001](#), for cable spacing information.

Wiring Examples

Topic	Page
Bulletin 1395 to PowerFlex DC Drive Comparison	165
Bulletin 1397 to PowerFlex DC Drive Comparison	165
FlexPak 3000 to PowerFlex DC Drive Comparison	173

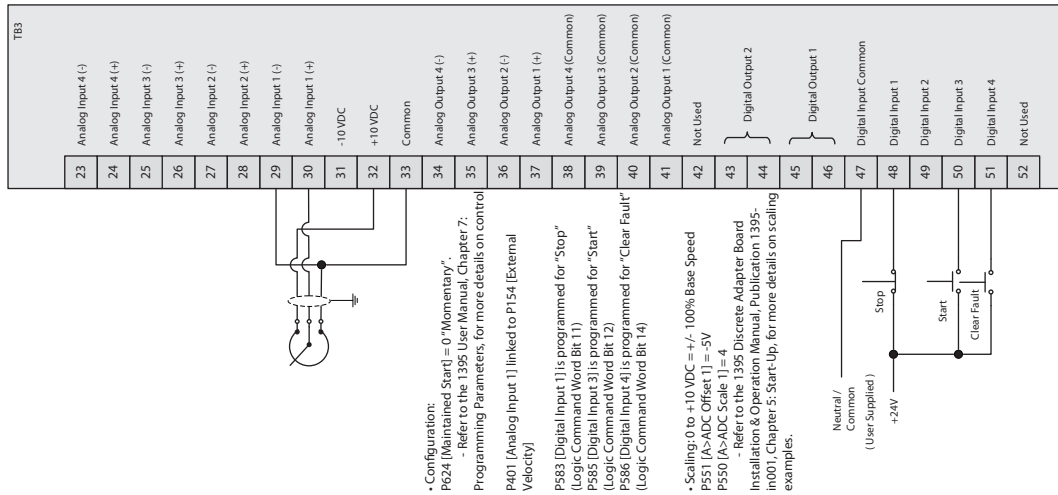
Bulletin 1395 to PowerFlex DC Drive Comparison

See the Bulletin 1395 Digital DC Drive User Manual, publication [1395-UM003](#), the Bulletin 1395 Discrete Adapter Board Installation & Operation Manual, publication [1395-IN001](#), or the Bulletin 1395 Digital Reference Adapter Board, publication [1395-RM001](#) for more details.

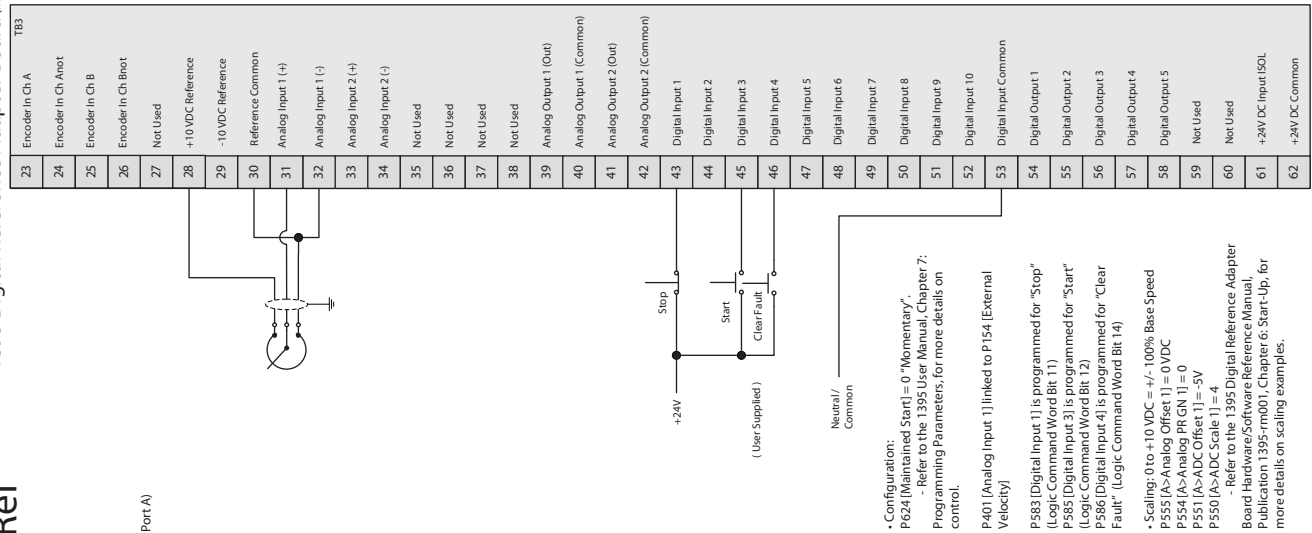
See the PowerFlex Digital DC Drive User Manual, publication [20P-UM001](#), for details on example wiring diagrams.

Three-wire Control, Pot Speed Ref

1395 Discrete Adapter Board (Mounted in Port A)



1395 Digital Reference Adapter Board (Mounted in Port A)



PowerFlex DC

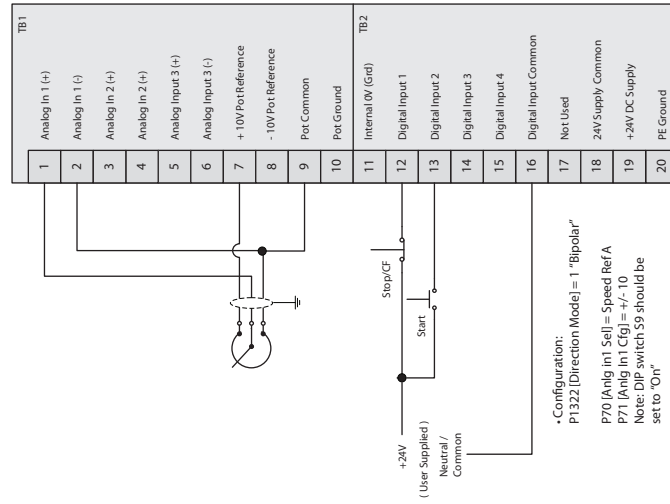
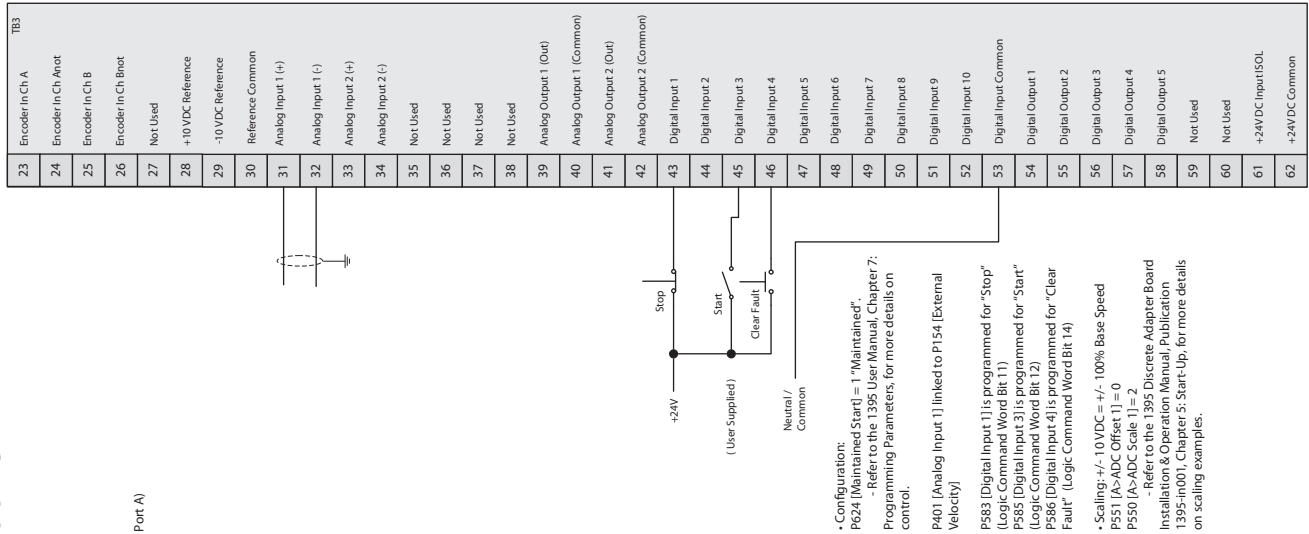


Figure 115 - Three-wire Control with Pot Speed Reference

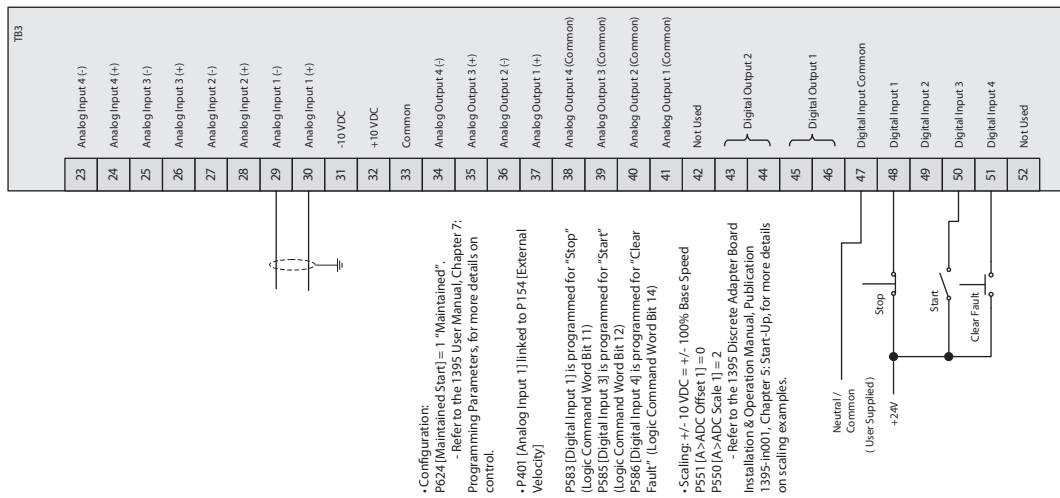
NOTE: If your 1395 drive utilizes 115 VAC inputs, refer to the PowerFlex DC user manual, Appendix G for details on the 115V AC to 24V DC I/O Converter Circuit Board.

Two-wire Control, Analog Input Ref

1395 Digital Reference Adapter Board (Mounted in Port A)

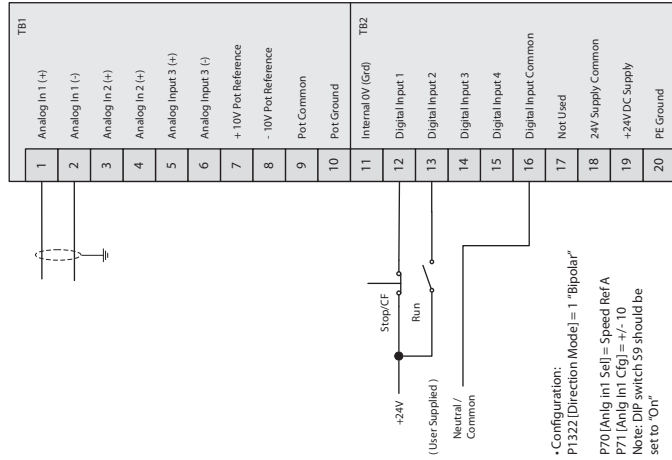


1395 Discrete Adapter Board (Mounted in Port A)



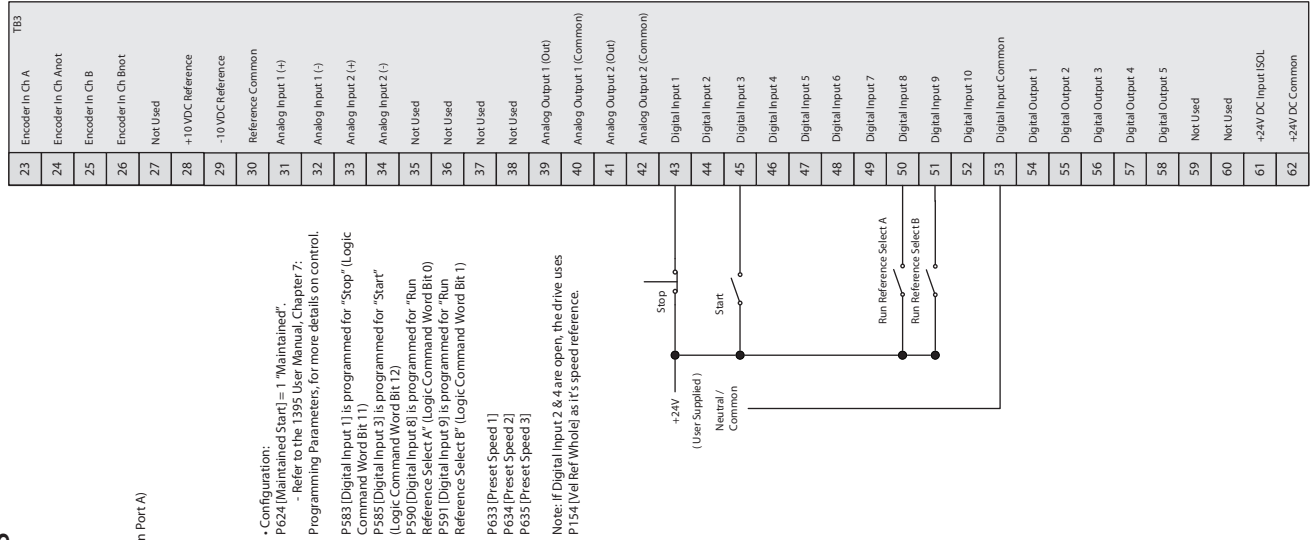
NOTE: If your 1395 drive utilizes 115 VAC inputs, refer to the PowerFlex DC user manual, Appendix G for details on the 115V AC to 24V DC I/O Converter Circuit Board.

PowerFlex DC

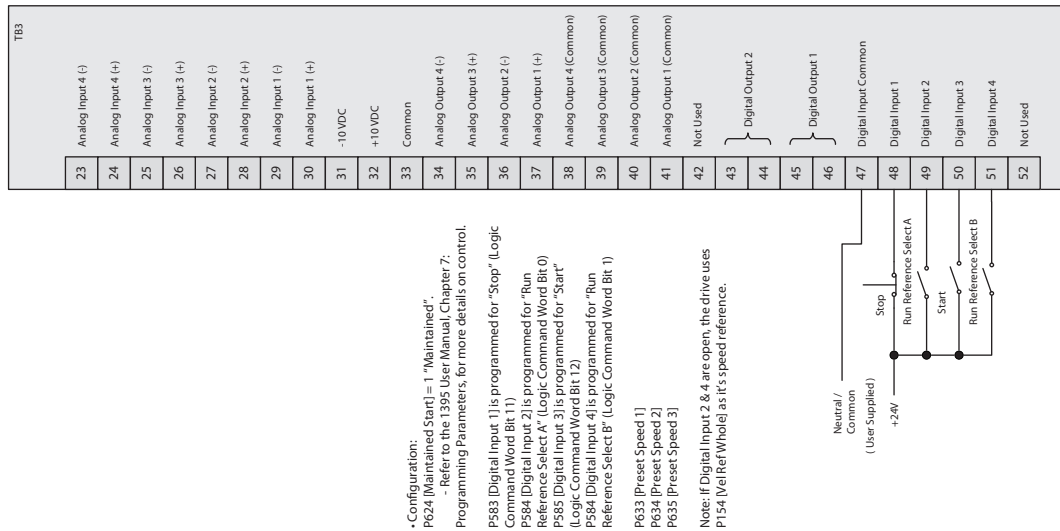


Two-wire Control, Preset Speeds

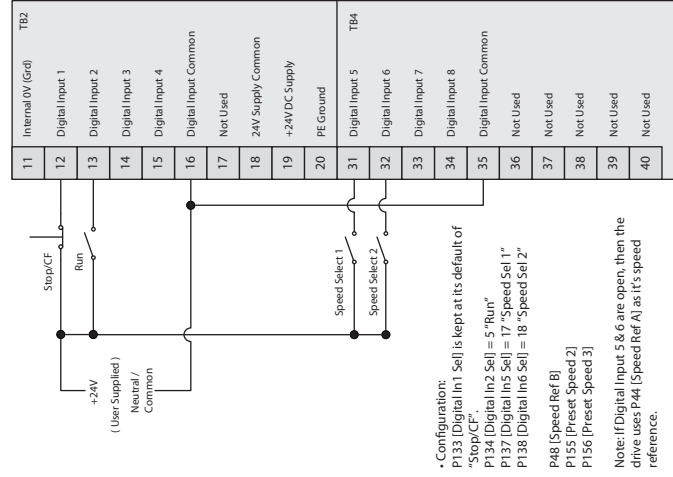
1395 Digital Reference Adapter Board (Mounted in Port A)



1395 Discrete Adapter Board (Mounted in Port A)



PowerFlex DC



NOTE: If your 1395 drive utilizes 115 VAC inputs, refer to the PowerFlex DC user manual, Appendix G for details on the 115V AC to 24V DC I/O Converter Circuit Board.

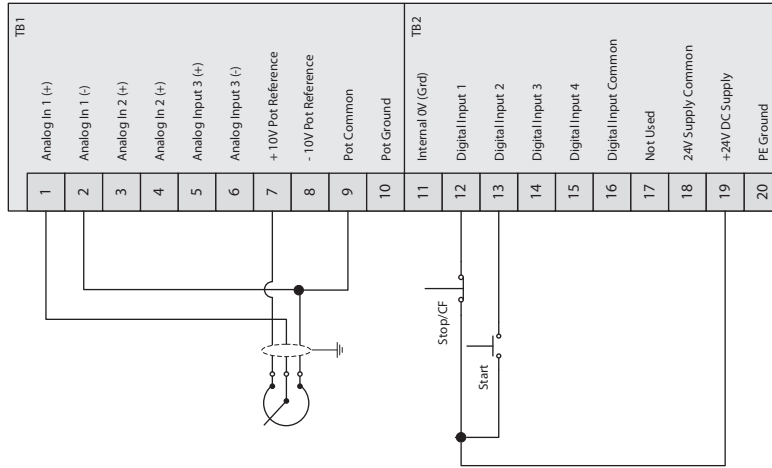
**Bulletin 1397 to PowerFlex
DC Drive Comparison**

See the 1397 D Drive User Manual, publication [1397-UM000](#), for more details.

See the PowerFlex Digital DC Drive User Manual, publication [20P-UM001](#), for details on example wiring diagrams.

Three-wire Control, Pot Speed Ref

PowerFlex DC



• Configuration:
P1322 [Direction Mode] = 1 "Bipolar"

P70 [Anlg In1 Sel] = Speed Ref A
P71 [Anlg In1 Cfg] = +/- 10
Note: DIP switch S9 should be set to "On"

P133 [Digital In1 Sel] and P134 [Digital In2 Sel] are kept at their default setting, "Stop/CF" and "Start" respectively.
- Refer to the PowerFlex DC User Manual, Publication 20-p-um001, Chapter 1: Installation and Wiring, for more details on wiring examples.

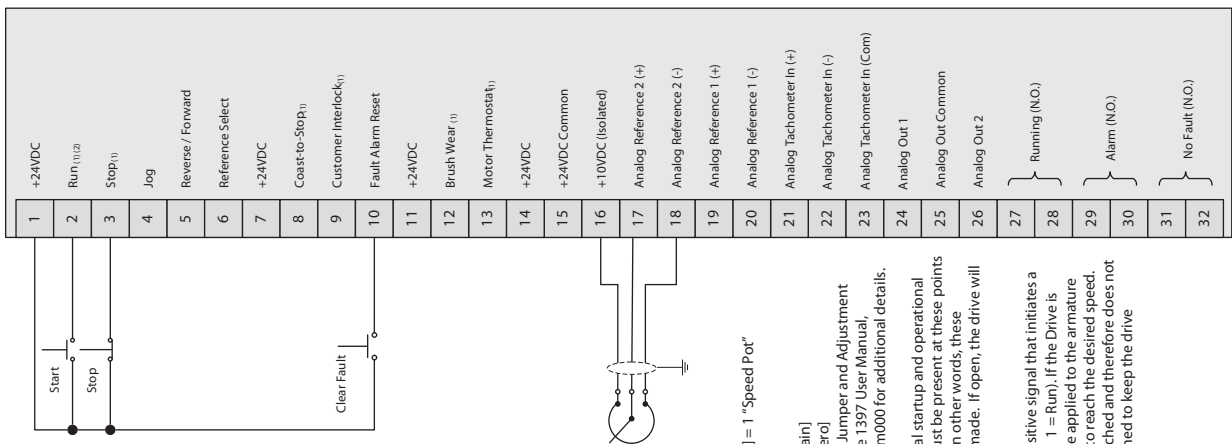
• Adjust Scaling:
P72 [Anlg In1 Scale]
P73 [Anlg1 Tune Scale]

• View Signal Value:
P1404 [Analog In1 Value]

• View Signal Output:
P385 [Speed Ref Out]

NOTE: If your 1397 drive utilizes 115 VAC inputs, refer to the PowerFlex DC user manual, Appendix G for details on the 115V AC to 24V DC I/O Converter Circuit Board.

1397 Regulator Board



• Configuration:
P91 – [Ref 2 Source] = 1 "Speed Pot"

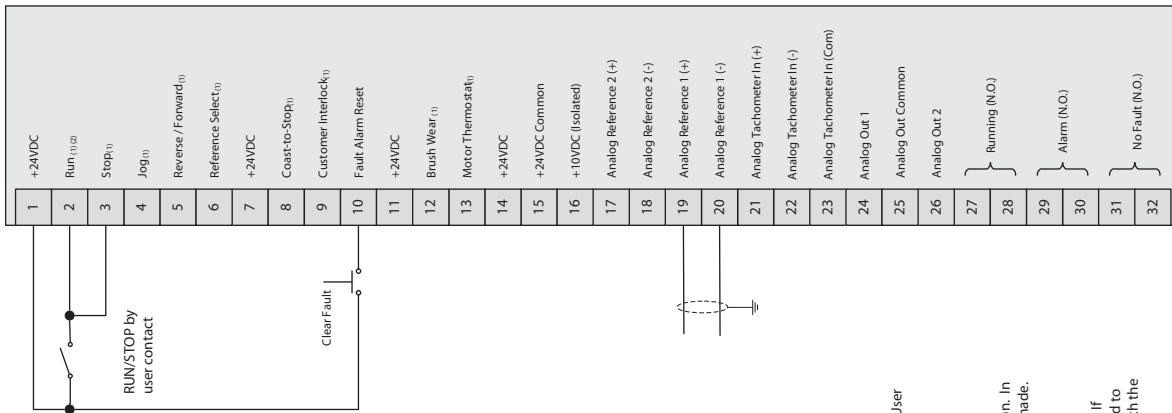
• Scaling:
P130 – [Anlg In 2 Gain]
P131 – [Anlg In 2 Zero]
- Refer to the Jumper and Adjustment Settings table in the 1397 User Manual, Publication 1397-um000 for additional details.

(1) Require for initial startup and operational checks. Voltage must be present at these points during operation. In other words, these terminals must be made. If open, the drive will be "Not Ready".

(2) RUN – Edge sensitive signal that initiates a Run command (008 1 = Run). If the Drive is Run, voltage may be applied to the armature causing the motor to reach the desired speed. The Run input is latched and therefore does not have to be maintained to keep the drive Running.

Two-wire Control, Analog Input Ref

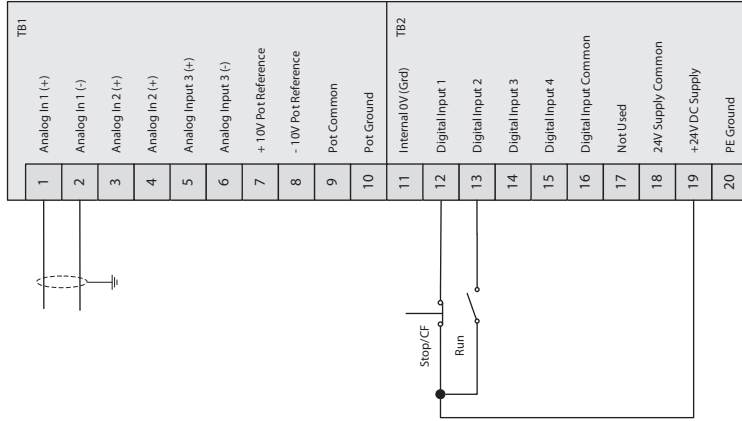
1397 Regulator Board



- Configuration:
P90 – [Ref 1 Source] = 0 "Anlg In 1"
- Scaling:
P127 – [Anlg In 1 Gain]
P128 – [Anlg In 1 Type]
P129 – [Anlg In 1 Zero]
Adjustment Settings table in the 1397 User Manual, Publication 1397-um000 for additional details.
- (1) Require for initial startup and operational checks. Voltage must be present at these points during operation. In other words, these terminals must be made. If open, the drive will be "Not Ready".
- (2) RUN – Edge sensitive signal that initiates a Run command (08 1 = Run). If the Drive is Run, voltage may be applied to the armature causing the motor to reach the desired speed.

NOTE: If your 1397 drive utilizes 115 VAC Inputs, refer to the PowerFlex DC user manual, Appendix G for details on the 115V AC to 24V DC I/O Converter Circuit Board.

PowerFlex DC

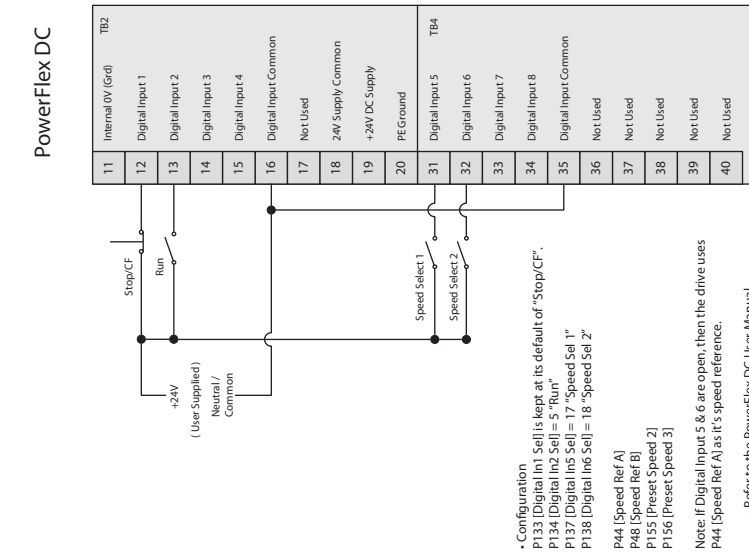
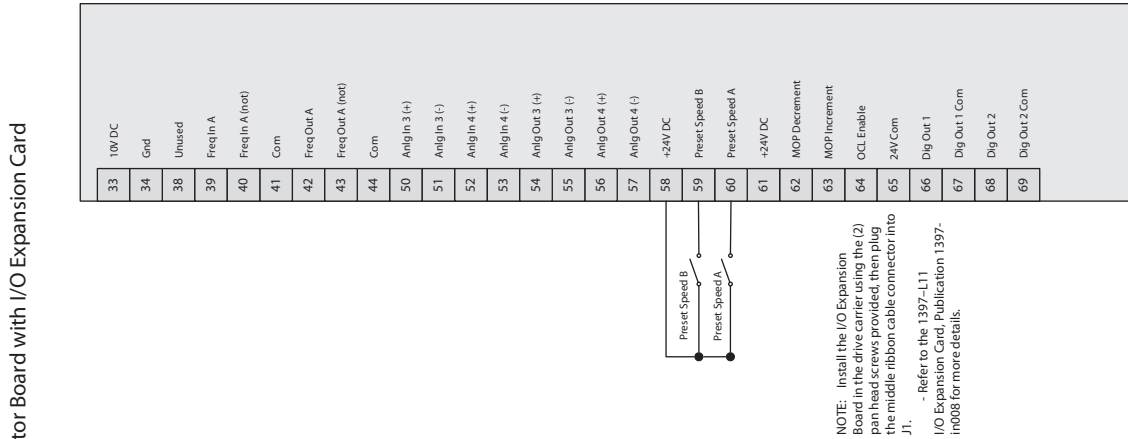
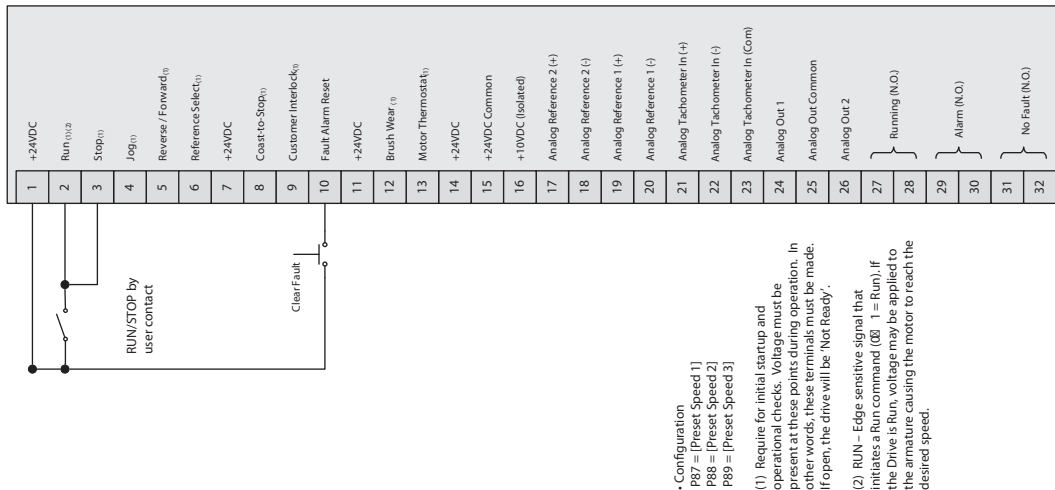


- Configuration:
P1322 [Direction Mode] = 1 "Bipolar"
- P70 [Anlg In1 Sel] = Speed Ref A
P71 [Anlg In1 Cfg] = +/- 10
Note: DIP switch S9 should be set to "On"
- P133 [Digital In 1 Sel] is kept at its default of "Stop/CF".
P134 [Digital In 2 Sel] = 5 "Run"
- Refer to the PowerFlex DC User Manual, Publication 20-p-um001, Chapter 1: Installation and Wiring, for more details on wiring examples.
- Scaling:
P72 [Anlg In1 Scale]
P73 [Anlg1 Tune Scale]
- View Signal Value:
P1404 [Analog In1 Value]
- View Signal Output:
P385 [Speed Ref Out]

Figure 119 - Two-wire Control with an Analog Input Speed Reference

Two-wire Control, Preset Speeds

1397 Regulator Board with I/O Expansion Card



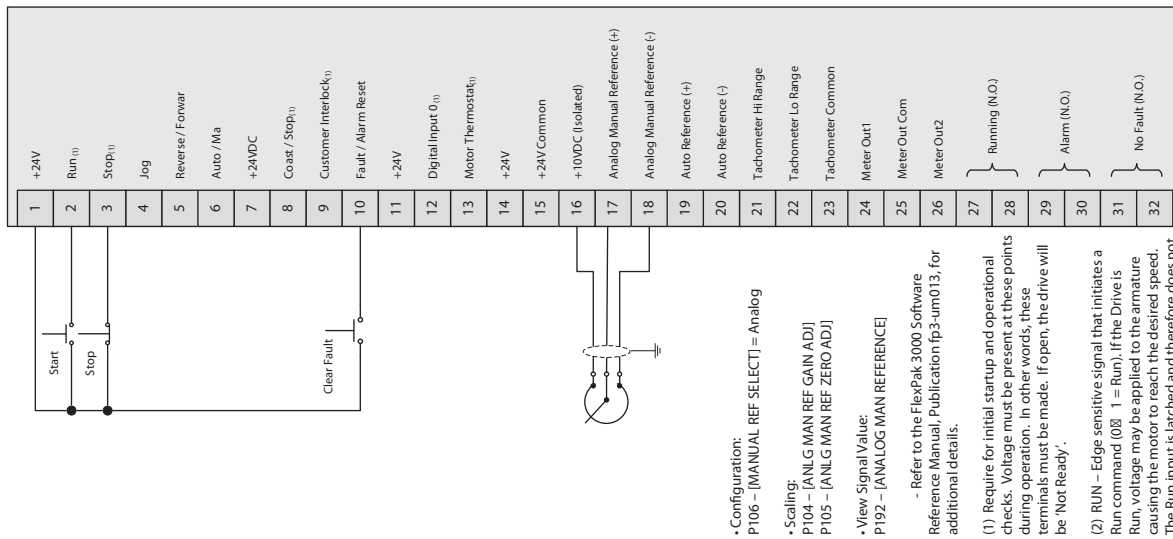
NOTE: If your drive utilizes 115 VAC inputs, refer to the PowerFlex DC user manual, Appendix G for details on the 115V AC to 24V DC I/O Converter Circuit Board.

FlexPak 3000 to PowerFlex DC Drive Comparison

See the FlexPak 3000 Hardware Reference, Installation and Troubleshooting Manual, publication [FP3-UM012](#), for more details.

See the PowerFlex Digital DC Drive User Manual, publication [20P-UM001](#), for details on example wiring diagrams.

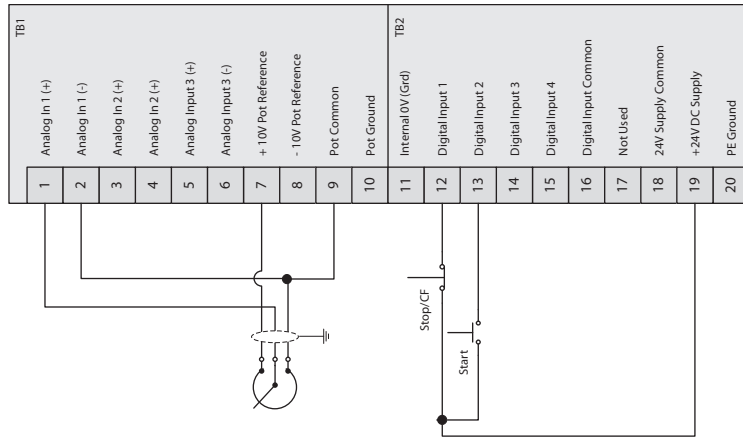
FlexPak 3000 Regulator Board



- Configuration: P106 – [MANUAL REF SELECT] = Analog
- Scaling: P104 – [ANLG MAN REF GAIN ADJ] P105 – [ANLG MAN REF ZERO ADJ]
- View Signal Value: P192 – [ANALOG MAN REFERENCE]
 - Refer to the FlexPak 3000 Software Reference Manual, Publication 1p3-um013, for additional details.
- (1) Require for initial startup and operational checks. Voltage must be present at these points during operation. In other words, these terminals must be made. If Open, the drive will be 'Not Ready'.
- (2) RUN – Edge sensitive signal that initiates a Run command (08 1 = Run). If the Drive is Run, voltage may be applied to the armature causing the motor to reach the desired speed. The Run input is latched and therefore does not have to be maintained to keep the drive Running

Three-wire Control, Pot Speed Ref

PowerFlex DC



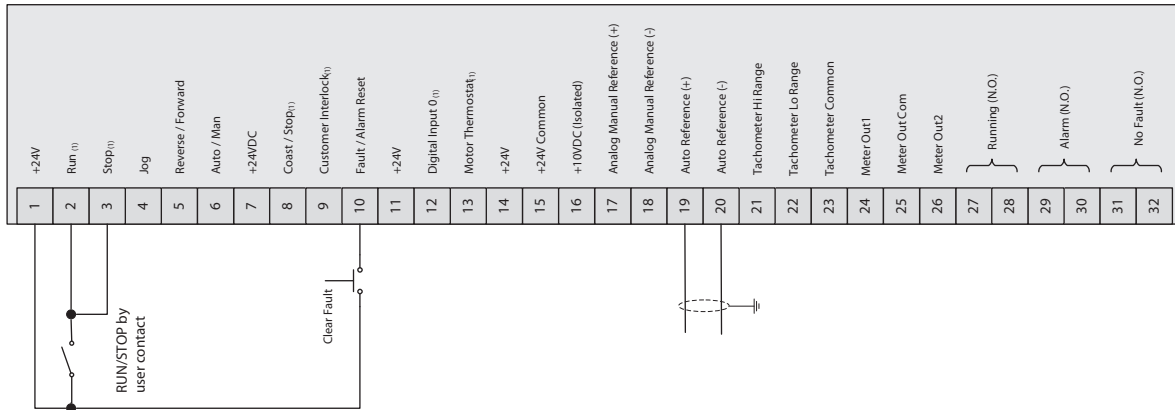
- Configuration: P1322 [Direction Mode] = 1 "Bipolar"
- P70 [Anlg In 1 Sel] = Speed Ref A
- P71 [Anlg In 1 Cfg] = +/- 10
- Note: DIP switch S9 should be set to "On"
- P133 [Digital In 1 Sel] and P134 [Digital In 2 Sel] are kept at their default setting, "Stop/CF" and "Start" respectively.
 - Refer to the PowerFlex DC User Manual, Publication 20-p-um001, Chapter 1: Installation and Wiring, for more details on wiring examples.
- Adjust Scaling: P72 [Anlg In 1 Scale] P73 [Anlg 1 Tune Scale]
- View Signal Value: P1404 [Analog In 1 Value]
- View Signal Output: P385 [Speed Ref Out]

Figure 121 - Three-wire Control with Pot Speed Reference

NOTE: If your 1397 drive utilizes 115 VAC inputs, refer to the PowerFlex DC user manual, Appendix G for details on the 115V AC to 24V DC I/O Converter Circuit Board.

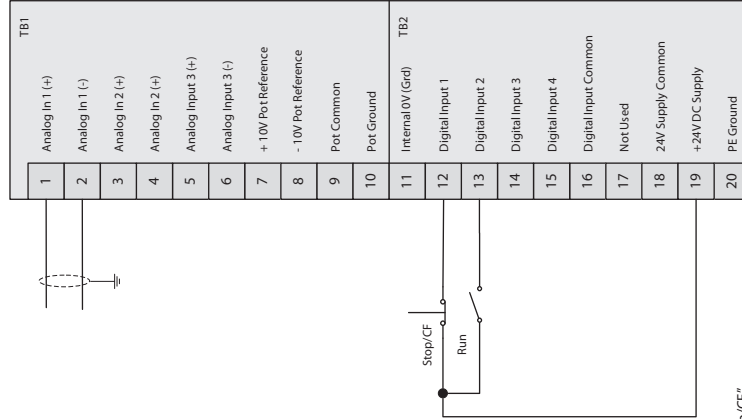
Two-wire Control, Analog Input Ref

FlexPak 3000 Regulator Board



NOTE: If your 1397 drive utilizes 115 VAC Inputs, refer to the PowerFlex DC user manual, Appendix G for details on the 115V AC to 24V DC I/O Converter Circuit Board.

PowerFlex DC



- Configuration:
P1322 [Direction Mode] = 1 "Bipolar"
- P70 [Anlg In1 Sel] = Speed Ref A
- P71 [Anlg In1 CF6] = +/- 10
- Note: DIP switch S9 should be set to "On"
- P133 [Digital In1 Sel] is kept at its default of "Stop/CF".
- P134 [Digital In2 Sel] = 5 "Run"
- Refer to the PowerFlex DC User Manual, Publication 20-p-um001, Chapter 1: Installation and Wiring, for more details on wiring examples.
- Scaling:
P72 [Anlg In1 Scale]
P73 [Anlg1 Tune Scale]
- View Signal Value:
P1404 [Analog In1 Value]
- View Signal Output:
P385 [Speed Ref Out]

Figure 122 - Two-wire Control with an Analog Input Speed Reference

- Configuration:
P103 - [AUTO REF SELECT] = Analog
 - Scaling:
P101 - [ANLG AUTO GAIN ADJ]
P100 - [ANLG AUTO SIGNAL TYPE]
P102 - [ANLG AUTO ZERO ADJ]
 - View Signal Value:
P188 - [ANALOG AUTO REFERENCE]
- Refer to the FlexPak 3000 Software Reference Manual, Publication fp3-um013, for additional details.
- (1) Require for initial startup and operational checks. Voltage must be present at these points during operation. In other words, these terminals must be made. If open, the drive will be "Not Ready".
 - (2) RUN - Edge sensitive signal that initiates a Run command (0 = Run). If the Drive is Run, voltage may be applied to the armature causing the motor to reach the desired speed.

Two-wire Control, Preset Speeds

FlexPak 3000 Regulator Board with I/O Expansion Card

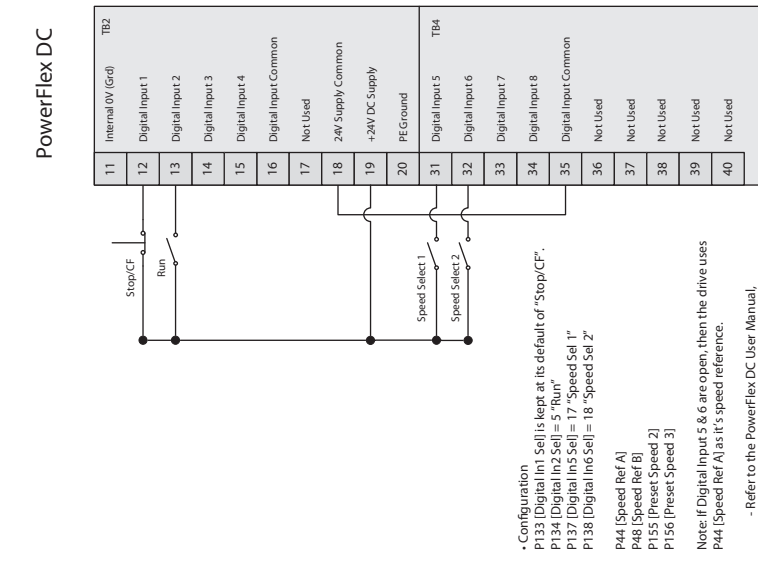
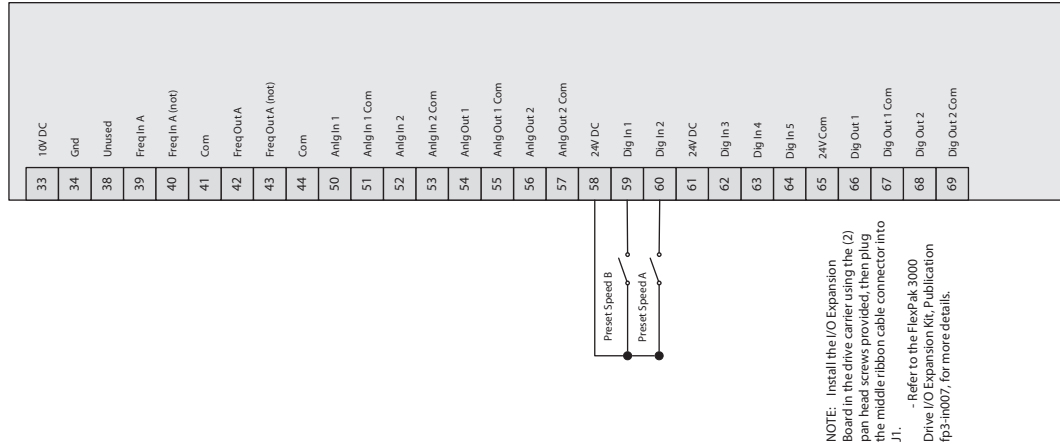
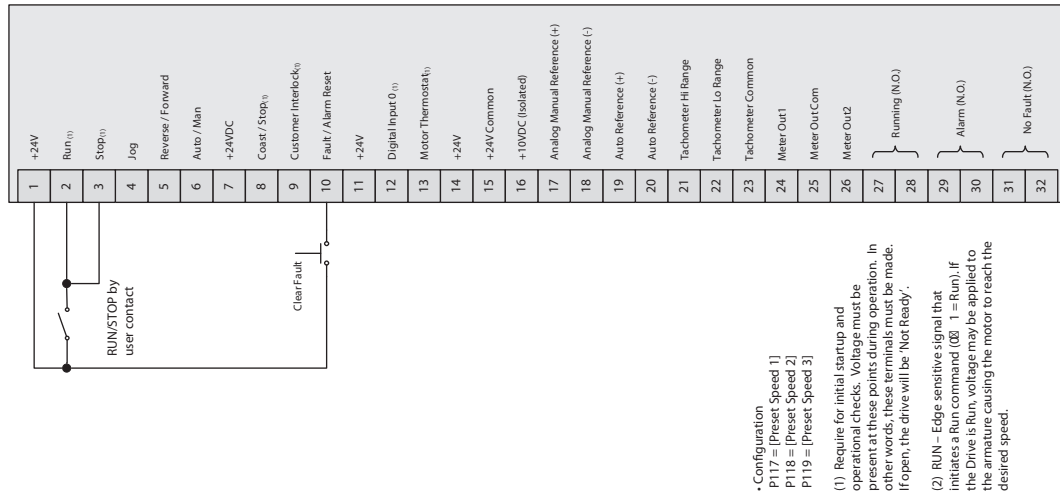


Figure 123 - Two-wire Control with Preset Speeds

NOTE: If your drive utilizes 115 VAC inputs, refer to the PowerFlex DC user manual, Appendix G for details on the 115V AC to 24V DC I/O Converter Circuit Board.

Network Communication

Topic	Page
Overview	177
Bulletin 1395 DC Drive Network Communication Options	177
Bulletin 1397 DC Drive Network Communication Options	179
FlexPak 3000 DC Drive Network Communication Options	180
PowerFlex DC Drive Network Communication Options	181
Logic Command and Status	182
Rockwell Automation Encompass Partner Migration Offerings	190

Overview

The process of migrating from a 1395, 1397, and FlexPak 3000 to a PowerFlex DC drive can vary significantly depending on the controller type communicating with the drive and the particular communication module installed in the drive.

This chapter describes which architecture-class (20-COMM) network options can be used with the PowerFlex DC drives. Because of the wide variety of networks, processors, and drive options to consider, only migration information is presented, rather than step-by-step procedures.

Bulletin 1395 DC Drive Network Communication Options

The 1395 drive has the following network communication options:

- Remote I/O
- Serial
- DF1
- Data Highway Plus
- ControlNet™

1395 Node Adapter Board

The Node Adapter board provides a sophisticated interface between external devices and the main control board. This adapter board provides the following features:

- Capable of configuration as a Remote I/O (RIO) interface
- Compatible with Allen-Bradley PLC3 or PLC5 family of programmable logic controllers (PLC)

The 1395 Node Adapter Board Installation and Operation Manual, publication [1395-IN017](#), contains the information necessary to perform the following functions:

- Install and set-up the Node Adapter board
- Configure the drive for control by a PLC
- Maintain and troubleshoot the board

Multi-Communication Board

The Multi-communication Adapter (MCA) board provides a sophisticated interface to an Allen-Bradley PLC and other equipment capable of communicating over serial communication links. This adapter board provides the following features:

- Two separate communications channels, each capable of being configured as Remote I/O (RIO) or Data Highway Plus (DH+) interfaces.
- Four programmable function blocks, which can be used to manipulate data.
- One programmable discrete input (24V DC or 115V AC).
- Compatible with Allen-Bradley PLC5/60, PLC5/40, PLC5/25, PLC5/15, PLC250, PLC3, and Control View.

The 1395 Multi-Communication Board Hardware/Software Reference Manual, publication [1395-RM000](#), contains the information necessary to perform the following functions:

- Install and set-up the MCA board
- Configure the drive for control by a PLC
- Maintain and troubleshoot the board

ControlNet Adapter Board

The ControlNet Adapter (CNA) board provides a sophisticated interface to an Allen-Bradley PLC and other equipment capable of communicating over ControlNet. This adapter board provides the following features:

- One ControlNet channel, with a redundant connector to allow for backup connection in case one cable fails.
- Compatible with all Allen-Bradley PLCs and other products that support programmable controller communication commands (PCCC).
- Compatible with Allen-Bradley 1395 drives equipped with version 8.10 or later software.

The 1395 ControlNet Communication Board User Manual, publication [1395-UM007](#), contains the information necessary to perform the following functions:

- Install and set-up the CNA board
- Configure the drive for control by a PLC
- Maintain and troubleshoot the board

Bulletin 1397 DC Drive Network Communication Options

The 1397 drive uses the SCANPort communication protocol with the following network communication options:

- Remote I/O (RIO)
- RS-232/422/485, DF1 and DH485 Protocol
- DeviceNet - 24 VDC
- ControlNet
- Ethernet/IP
- Profibus DP (ProSoft)
- Modbus Plus (ProSoft)
- Modbus RTU (ProSoft)
- Metasys N2 (ProSoft)
- LonWorks (ProSoft)

See Appendix D, Using SCANPort Capabilities, in the 1397 DC Drive User Manual, publication [1397-UM000](#), for details on the following communication topics:

- Understanding the Logic Command and Status parameter
- Configuring the SCANPort controls
- Setting the loss of communication fault
- Using the SCANPort I/O image

For more details on the respective 1203 communication adapter user manuals, see the Rockwell Automation Literature Library at <http://www.rockwellautomation.com/literature/>.

Also, for any relevant technical documents, see the Rockwell Automation Knowledgebase at <https://rockwellautomation.custhelp.com/>.

FlexPak 3000 DC Drive Network Communication Options

A DeviceNet Interface board, AutoMax Network Communication board, or ControlNet Network Communication board may be installed in the drive. See Chapter 10, Configuring a Network, in the The FlexPak 3000 Digital DC Drive Software Reference Manual, publication [FP3-UM013](#), for a description of the parameters used to configure for these networks.

For information on the DeviceNet, AutoMax, or ControlNet networks, see the appropriate network manual.

Some parameters are only accessible over the network using the alternate register map (NETW REGISTER MAP SEL (P.914) set to ALTERNATE).

See the appropriate option board instruction manual for more information.

ControlNet Network Communication Option Board

This option allows a FlexPak 3000 DC drive to send and receive data via a control processor over the ControlNet network. FlexPak 3000 drives (version 4.2 or later) are compatible with all versions of the network option board. See the ControlNet Network Communication Option Board Instruction Manual, publication [PPF3-IN024](#), for more details.

AutoMax Network Communication Option Board

This board enables a FlexPak 3000 DC drive for operation and monitoring over the AutoMax network.

For normal operation, the drive can be completely controlled using the AutoMax Network option board. This option provides drive control using only a network interface connection with a hard-wired emergency stop and three-phase input and output power wiring. Drive control (such as start, stop, and reset), reference changes, parameter modification, and drive monitoring can all be performed over the AutoMax network.

Refer to the AutoMax Network Communication Option Board Instruction Manual, publication [FP3-IN010](#), for more details.

DeviceNet Network

See [DeviceNet Network for use with Reliance Electric FlexPak 3000 DC Drive](#) for details in using the DeviceNet network with FlexPak 3000 DC drives. This is also highlighted in Rockwell Automation Knowledgebase ID# 64604. See the Rockwell Automation Knowledgebase at <https://rockwellautomation.custhelp.com/>.

PowerFlex DC Drive Network Communication Options

The PowerFlex DC drive supports the following network communication protocols:

- BACnet MS/TP RS485 Communication Adapter: 20-COMM-B
- ControlNet Communication Adapter (Coax): 20-COMM-C
- DeviceNet Communication Adapter: 20-COMM-D
- EtherNet/IP Communication Adapter: 20-COMM-E
- HVAC Communication Adapter: 20-COMM-H
- Interbus Communication Adapter: 20-COMM-I
- PROFIBUS DP Communication Adapter: 20-COMM-P
- ControlNet Communication Adapter (Fiber) 20-COMM-Q
- Remote I/O Communication Adapter: 20-COMM-R
- RS485 DF1 Communication Adapter: 20-COMM-S
- External Communications Kit Power Supply: 20-XCOMM-PS1 *
- DPI External Communications Kit: 20-XCOMM-DC-BASE
- External DPI I/O Option Board: 20-XCOMMIO-OPT1
- Compact I/O to DPI/SCANport Module 1769-SM1
- Serial Null Modem Adapter: 1203-SNM

* For use only with External DPI Communications Kits
20-XCOMM-DCBASE.

Refer to the respective communication adapter user manuals for details. See the Rockwell Automation Literature Library at <http://www.rockwellautomation.com/literature/>.

Also, for any relevant technical documents, see the Rockwell Automation Knowledgebase at <https://rockwellautomation.custhelp.com/>.

Logic Command and Status

Summaries of the Logic Command and Status words for each drive are included below.

Bulletin 1395 DC Drive

Parameter 150: Logic Command 1 [Logic Cmd 1]

Internal units: None

Programming Terminal units: Bit Field

Description: This is a word of fast data used to control drive logic operation. The information is contained in binary (boolean) form. If a bit is set, the associated function is enabled, otherwise the function is disabled (inactive). The functions contained in Logic Command 1 are similar to those in Logic Command 2 and 3. The software checks the state of this signal in Logic Command 3. It then checks to see if the Command Enable Signal is present in Logic CMD 1 before making the selection of Logic Command 1 or 2. In Logic Command 2, the command enable bit is ignored. Regardless of the selected Logic Command word (1, 2, or 3), a Stop request from any Logic Command word will be honored.

The bits in the Logic Command words are defined as follows:

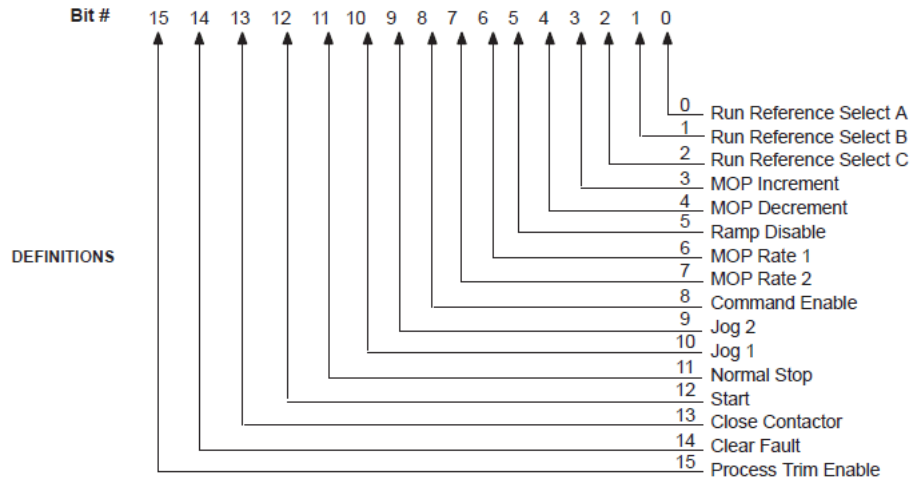


Table 75 - Logic Command Word Bits 0, 1, 2

Bit			Definition	Selected Parameters
2	1	1		
0	0	0	External Speed Reference	154
0	0	1	Preset Speed 1	633
0	1	0	Preset Speed 2	634
0	1	1	Preset Speed 3	635
1	0	0	Preset Speed 4	636
1	0	1	Preset Speed 5	637
1	1	0	MOP Forward Speed	MOP
1	1	1	MOP Reverse Speed	MOP

Table 76 - Logic Command Word Bits 6, 7

Bit		Definition	Selected Parameters
7	6		
0	0	MOP 1 Accel, Decel	641, 645
0	1	MOP 2 Accel, Decel	642, 646
1	0	MOP 3 Accel, Decel	643, 647
1	1	MOP 4 Accel, Decel	644, 648

Table 77 - Logic Command Word Bits 8

Bit 8	1	0
Logic Command 1	Drive Active From Logic Command 1 ⁽¹⁾	Drive Active From Logic Command 2
Logic Command 2	Bit 8 Ignored	Bit 8 Ignored
Logic Command 3	Drive Active From Logic Command 3	Logic Command 1 Checked

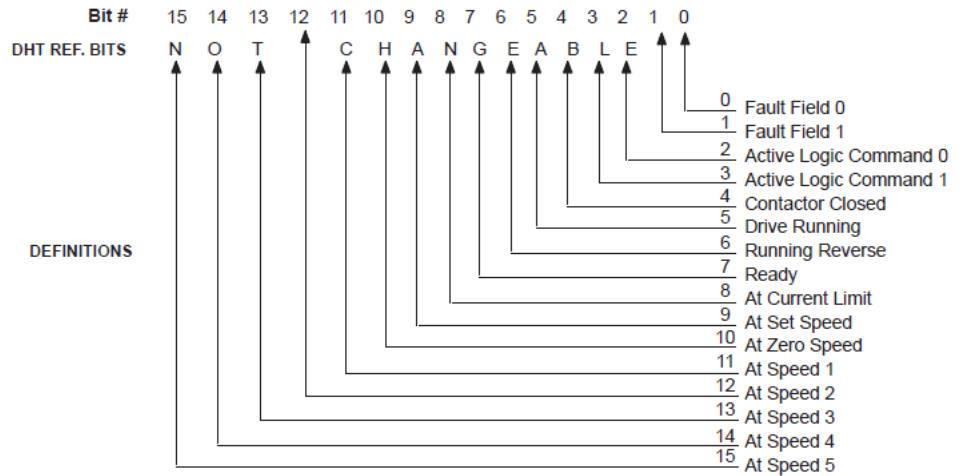
(1) If Logic Command 3 is 0

Parameter 100: Logic Status [Logic Status]

Internal Units: None

Programming Terminal units: Bit Field

Description: This is a word of status data that indicates conditions within the Drive in boolean logic. Where a bit is set to 1, the corresponding condition in the drive is true, otherwise the condition is false. The bits in the Logic Status word are defined as:



Fault Field 0, 1 (Bits 0, 1): This 2-bit field denotes the fault status of the drive as follows:

Flt.Fld. 1	Flt. Fld. 0	Definition
0	0	No Fault
0	1	Warning Fault
1	0	Soft Fault
1	1	Hard Fault

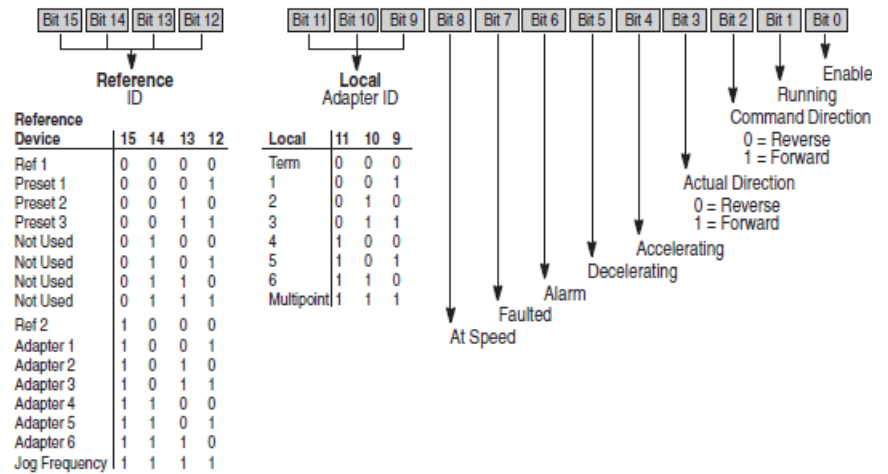
Active Logic Command 0,1 (Bits 2,3): This 2-bit field denotes the logic command the drive is acting upon as follows:

Logic CMD 1	Logic CMD 0	Definition
0	1	Parameter 150
0	0	Parameter 151
1	1	Parameter 152

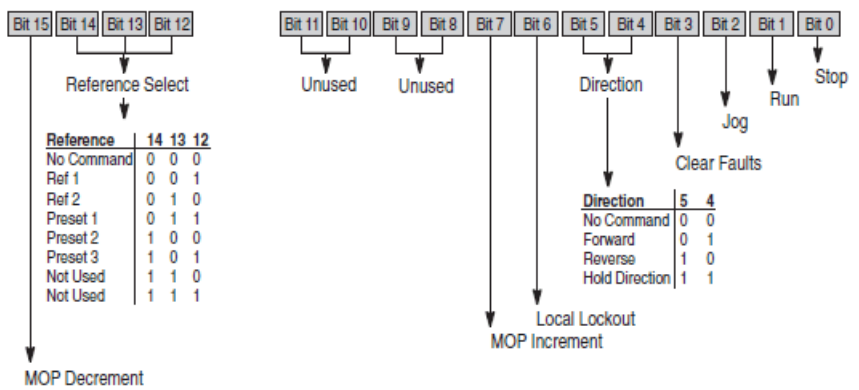
See Chapter 7, Programing and Parameters, of the Bulletin 1395 Digital DC Drive User Manual, publication [1395-UM003](#). for more details.

Bulletin 1397 DC Drive

Logic Status Format



Logic Command Format



See Appendix D, Using SCANport Capabilities, of the 1397 DC Drive Firmware 2.xx User Manual, publication [1397-UM000](#), for more details.

FlexPak 3000 DC Drive

Logic Status Format

Name	Description (Drive to PLC)
Word 0 Drive Status Word 1	Indicates drive status
Bit 00 Ready	0 = Not ready, 1 = Ready
Bit 01 Running	0 = Stopped, 1 = Running
Bit 02 Fault	0 = No Fault, 1 = Fault
Bit 03 Jogging	0 = Not jogging, 1 = Jogging
Bit 04 Actual direction	0 = Forward, 1 = Reverse
Bit 05 Stopping	0 = Not stopping, 1 = Stopping
Bit 06 Mode	0 = Manual, 1 = Auto
Bit 07 At speed reference	0 = Not at reference, 1 = At reference
Bit 08 Alarm	0 = No alarm, 1 = Alarm
Bit 09 Current Limit	0 = Not limited, 1 = Current limited
Bit 10 Parameter Process Error	0 = No Error, 1 = Error
Bit 11 Level Detect 1 Output	0 = Off, 1 = On
Bit 12 Level Detect 2 Output	0 = Off, 1 = On
Bit 13 Acceleration	0 = Not accelerating, 1 = Accelerating
Bit 14 Deceleration	0 = Not decelerating, 1 = Decelerating
Bit 15 Reserved	Reserved
Word 1 Speed Feedback	The speed of the motor as measured by the drive. Range is ± 4095 . The units depend on the value of FEEDBACK SELECT (P.200). 1 = 1/4095 of TOP SPEED (P.011).
Word 2 Current Feedback	The current being supplied by the drive. Range ± 4095 . Units are amps. 1 = 1/4095 of product of MAXIMUM CURRENT (P.007) and MOTOR RATED ARM AMPS (P.008).
Word 3 Network Output 1	Displays value selected by NETW OUT REG 1 SELECT (P.902).
Word 4 Network Output 2	Displays value selected by NETW OUT REG 2 SELECT (P.903).
Word 5 Network Output 3	Displays value selected by NETW OUT REG 3 SELECT (P.904).
Word 6 Speed Feedback Gain	Displays the value of SPEED FEEDBACK GAIN, range 1000 to 32000 (1000 = 1.000).
Word 7 Speed Loop PI Initial Value	Initial value of speed loop PI block when CONTROL SOURCE SELECT (P.000) is NETWORK and Spd Loop PI Reset (bit 06, Drive Control Word) is set to 1. Range -32768 to 32767.

Logic Command Format

Name	Description (PLC to Drive)
Word 0 Drive Control Word	This word consists of a set of bits written to by the PLC to control the state of the drive (only when CONTROL SOURCE SELECT = NETWORK).
Bit 00 Run	Starts the drive in run mode. A 0-to-1 transition causes the drive to start (if ready). Setting this bit to zero (0) does not stop the drive.
Bit 01 Stop	A value of 0 stops the drive. A value of 1 allows the drive to become ready.
Bit 02 Fault Reset	Resets (only) the latched fault on a 0-to-1 transition. This bit does not affect the contents of the fault log.
Bit 03 Jog/Stop	Starts the drive in jog mode. A 0-to-1 transition causes the drive to start (if ready). Setting this bit to zero (0) causes the drive to stop (only after jog time-out or if no run command is asserted).
Bit 04 Forward/Reverse	Operating direction command: Forward (0) or reverse (1).
Bit 05 Overwind/Underwind	Selects the direction in winder applications; overwind (0) or underwind (1).
Bit 06 Speed Loop PI Reset	Selects the operational state of the Speed Loop PI block; normal (0) or reset (1).
Bit 07 OCL Enable	Disables/holds in reset (0) or enables (1) the Outer Control Loop.
Bit 08 Fault Log Clear, Reset	Clears the fault log contents on a 0-to-1 transition and resets the latched fault.
Bit 09 Alarm Log Clear, Reset	Clears the alarm log contents on a 0-to-1 transition and resets the alarm indicator.
Bit 10 Alarm Reset	Resets (only) the alarm on a 0-to-1 transition. This bit does not affect the alarm log.
Bit 11 Memory Save	Performs a memory save operation in the drive on a 0-to-1 transition.
Bit 12 - 15 Reserved	Reserved
Word 1 Speed/Torque Reference	This word is written to by the ControlNet network to command a speed or torque reference. When the drive is configured as a speed regulator, a value of 4095 corresponds to TOP SPEED (P.011). When the drive is configured as a torque/current regulator, a value of 4095 corresponds to MAXIMUM CURRENT (P.007) percent of MOTOR RATED ARM AMPS (P.008).
Word 2 Field Reference	This word is written to by the ControlNet network to command a field reference value. $1 = 1/4095$ of MOTOR HOT FLD AMPS (P.510). This value is only used by the drive if a field current regulator kit is installed.
Word 3 Network Input 1	A value that is input in various places of the speed loop.
Word 4 Network Input 2	A value that is input in various places of the speed loop.
Word 5 Network Input 3	A value that is input in various places of the speed loop.
Word 6 Speed Feedback Gain	Value (1000 = 1.000) multiplied by speed feedback (range 1000 to 32000. Used in simple winder applications for roll diameter compensation.
Word 7 Speed Loop PI Initial Value	Initial value of speed loop PI block when CONTROL SOURCE SELECT (P.000) = NETWORK and Spd Loop PI Reset (bit 06, Drive Control Word) = 1. Range -32768 to 32767.

See Chapter 4, Programming the Drive, of the FlexPak 3000 ControlNet Network Communication Option Board Installation Instruction, publication [FP3-IN024](#), for more details.

PowerFlex DC Drive

Typical Programmable Controller Configurations

IMPORTANT If block transfers are programmed to continuously write information to the drive, care must be taken to properly format the block transfer. If attribute 10 is selected for the block transfer, values will be written only to RAM and will not be saved by the drive. This is the preferred attribute for continuous transfers. If attribute 9 is selected, each program scan will complete a write to the drives non-volatile memory (EEProm). Since the EEPROM has a fixed number of allowed writes, continuous block transfers will quickly damage the EEPROM. Do Not assign attribute 9 to continuous block transfers. Refer to the individual communications adapter User Manual for additional details.

Logic Command/Status Words

See parameter 1328 [Drive Logic Rslt] for more information.

Figure 124 - Logic Command Word

Logic Bits																Command	Description
15	14	13	12	11	10	9	8	7	6	5	4	3	2	1	0		
															x	Stop ⁽¹⁾	0 = Not Stop 1 = Stop
															x	Start ⁽¹⁾⁽²⁾	0 = Not Start 1 = Start
															x	Jog	0 = Not Jog 1 = Jog
															x	Clear Faults	0 = Not Clear Faults 1 = Clear Faults
										x	x					Direction	00 = No Command 01 = Forward Command 10 = Reverse Command 11 = Hold Present Direction
										x						Local Control	0 = No Local Control 1 = Local Control
															x	MOP Increment	0 = Not Increment 1 = Increment
															x	Accel Rate	00 = No Command 01 = Use Accel Time 1 10 = Use Accel Time 2 11 = Use Present Time
															x	Decel Rate	00 = No Command 01 = Use Decel Time 1 10 = Use Decel Time 2 11 = Use Present Time
															x	Reference Select ⁽³⁾	000 = No Command 001 = Ref. 1 (Spd Ref A) 010 = Ref. 2 (Spd Ref B) 011 = Ref. 3 (Preset Spd 3) 100 = Ref. 4 (Preset Spd 4) 101 = Ref. 5 (Preset Spd 5) 110 = Ref. 6 (Preset Spd 6) 111 = Ref. 7 (Preset Spd 7)
															x	MOP Decrement	0 = Not Decrement 1 = Decrement

- (1) A "0 = Not Stop" condition (logic 0) must first be present before a "1 = Start" condition will start the drive. The Start command acts as a momentary Start command. A "1" will start the drive, but returning to "0" will not stop the drive.
- (2) This Start will not function if a digital input (parameters 13...144) is programmed for 2-Wire Control (option 5 "Run", 6 "Run Forward" or 7 "Run Reverse").
- (3) This Reference Select will not function if a digital input (parameters 131...144) is programmed for "Speed Sel 1, 2 or 3" (option 17, 18 or 19). Note that Reference Selection is "Exclusive Ownership".

Figure 125 - Logic Status Word

Logic Bits																Status	Description
15	14	13	12	11	10	9	8	7	6	5	4	3	2	1	0		
															x	Ready	0 = Not Ready 1 = Ready
															x	Active	0 = Not Active 1 = Active
															x	Command Direction	0 = Reverse 1 = Forward
														x		Actual Direction	0 = Reverse 1 = Forward
													x			Accel	0 = Not Accelerating 1 = Accelerating
														x		Decel	0 = Not Decelerating 1 = Decelerating
															x	Alarm	0 = No Alarm 1 = Alarm
															x	Fault	0 = No Fault 1 = Fault
															x	At Speed	0 = Not At Reference 1 = At Reference
																Local Control ⁽¹⁾	000 = Port 0 (TB) 001 = Port 1 010 = Port 2 011 = Port 3 100 = Port 4 101 = Port 5 110 = Reserved 111 = No Local
x	x	x	x													Reference Source	0000 = Spd Ref A Auto 0001 = Spd Ref B Auto 0010 = Preset Spd 2 Auto 0011 = Preset Spd 3 Auto 0100 = Preset Spd 4 Auto 0101 = Preset Spd 5 Auto 0110 = Preset Spd 6 Auto 0111 = Preset Spd 7 Auto 1000 = Term Blk Manual 1001 = DPI 1 Manual 1010 = DPI 2 Manual 1011 = DPI 3 Manual 1100 = DPI 4 Manual 1101 = DPI 5 Manual 1110 = Reserved 1111 = Jog Ref

(1) See the Masks & Owners parameter group in the PowerFlex Digital DC Drive User Manual for further information.

See Appendix A, Supplemental Drive Information, of the PowerFlex Digital DC Drive User Manual, [20P-UM001](#), for more details.

Rockwell Automation Encompass Partner Migration Offerings

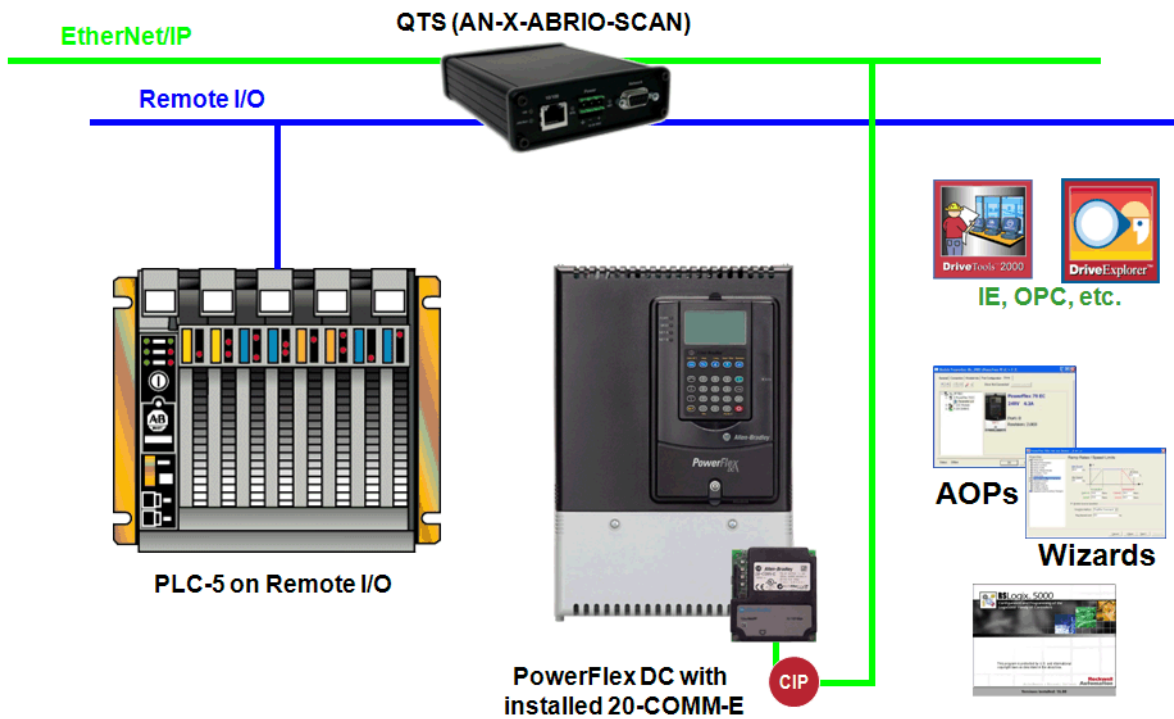
The Rockwell Automation Encompass program creates a path for critical information exchange and improved product solutions by linking the technical and commercial resources of Rockwell Automation and the best suited Encompass partner.

Encompass partners are companies that have a range of product capabilities which extend and enhance Rockwell Automation solutions. These partners have completed a rigorous membership process and are committed to the success of our mutual customers.

Please refer to the Encompass Product Partner Quick Application Reference, Publication [ENCOMP-QR004](#), for more details on the program.

Prosoft Technology is a company that is a part of the Rockwell Automation Encompass Partner program. Below is a list of modules they provide that can help be an interim step in migrating drives with communication networks such as Remote I/O and Data Highway Plus to EtherNet/IP without replacing the entire communications network.

Figure 126 - Example Network Migration Strategy





ProLinx 5210-DFNT-RIO

- ProLinx 5210-DFNT-RIO from ProSoft Technologies
- Stand-alone, DIN-rail mountable protocol gateway creates a powerful connection between devices on EtherNet/IP and Remote I/O networks
- EtherNet/IP port supports Explicit Messaging and user-configurable as both a Client and a Server
- Remote I/O port connects to a scanner (master) that controls the data transfer and supports limited high speed data transfer via the Input and Output images
- Enables easy connection to Rockwell Automation controllers (CLX, SLC, PLC, etc)
- Website: <http://www.prosoft-technology.com/content/view/full/7401#>



ProLinx 5201-DFNT-DH485

- Stand-alone, DIN-rail mountable protocol gateway creates a powerful connection between devices on EtherNet/IP and DH485 networks
- EtherNet/IP port supports Explicit Messaging and user-configurable as both a Client and a Server
- DH485 port supports both Master and Slave modes, and user-configurable data mapping from device control I/O
- Enables easy connection to Rockwell Automation controllers (CLX, SLC, PLC, etc)
- Website: <http://www.prosoft-technology.com/content/view/full/7486>



AN-X-ABRIO-SCAN

- The AN-X-ABRIO-SCAN product line connects Ethernet enabled devices to an Allen-Bradley Remote I/O network
- The AN-X-ABRIO-SCAN product is especially well-suited for replacing aging PLC's and other control elements with modern Allen-Bradley ControlLogix™, MicroLogix™ 1100/1400e or any other Ethernet/IP-enabled PLC
- Website: <http://www.qtsusa.com/>

AN-X-DHP



The AN-X Data Highway+ product line allows virtually transparent access from any Ethernet-enabled device to any Data Highway+ PLC or device

Use the power of Ethernet connectivity to upgrade your Data Highway+ networks for programming/monitoring, HMI applications or remote network capture and diagnostics

Website: <http://www.qtsusa.com/dhp.html>

AN-X-DCSNet



- The AN-X-DCSNet AutoMax communications module connects a computer or other device to a Reliance DCS network, using Ethernet
- Can act as a DCS master or a DCS slave
- Built-in web interface for configuration of DCSNet operation, and for monitoring operation and data
- Website: <http://www.qtsusa.com/automax.html>

Rockwell Automation Support

Rockwell Automation provides technical information on the Web to assist you in using its products.

At <http://www.rockwellautomation.com/support>, you can find technical manuals, technical and application notes, sample code and links to software service packs, and a MySupport feature that you can customize to make the best use of these tools. You can also visit our Knowledgebase at <http://www.rockwellautomation.com/knowledgebase> for FAQs, technical information, support chat and forums, software updates, and to sign up for product notification updates.

For an additional level of technical phone support for installation, configuration, and troubleshooting, we offer TechConnectSM support programs. For more information, contact your local distributor or Rockwell Automation representative, or visit <http://www.rockwellautomation.com/support/>.

Installation Assistance

If you experience a problem within the first 24 hours of installation, review the information that is contained in this manual. You can contact Customer Support for initial help in getting your product up and running.

United States or Canada	1.440.646.3434
Outside United States or Canada	Use the Worldwide Locator at http://www.rockwellautomation.com/support/americas/phone_en.html , or contact your local Rockwell Automation representative.

New Product Satisfaction Return

Rockwell Automation tests all of its products to ensure that they are fully operational when shipped from the manufacturing facility. However, if your product is not functioning and needs to be returned, follow these procedures.

United States	Contact your distributor. You must provide a Customer Support case number (call the phone number above to obtain one) to your distributor to complete the return process.
Outside United States	Please contact your local Rockwell Automation representative for the return procedure.

Documentation Feedback

Your comments will help us serve your documentation needs better. If you have any suggestions on how to improve this document, complete this form, publication [RA-DU002](#), available at <http://www.rockwellautomation.com/literature/>.

www.rockwellautomation.com

Power, Control and Information Solutions Headquarters

Americas: Rockwell Automation, 1201 South Second Street, Milwaukee, WI 53204-2496 USA, Tel: (1) 414.382.2000, Fax: (1) 414.382.4444
Europe/Middle East/Africa: Rockwell Automation NV, Pegasus Park, De Kleetlaan 12a, 1831 Diegem, Belgium, Tel: (32) 2 663 0600, Fax: (32) 2 663 0640
Asia Pacific: Rockwell Automation, Level 14, Core F, Cyberport 3, 100 Cyberport Road, Hong Kong, Tel: (852) 2887 4788, Fax: (852) 2508 1846