

SIEMENS

SINAMICS DCM

Base Drive panel instructions — version 3.0

High-performance drives

Converter software version:

As these Operating Instructions went to print, SINAMICS DCM converters were being delivered from the factory with **software version 1.4 installed**.

These Operating Instructions also apply to *other software versions*.

Earlier software versions: *Some parameters* described in this document *might not be available in the software* (i.e. the corresponding functionality is not available on the converter) or some parameters will have a restricted setting range. Sinamics DCM Base Drive Panel series requires software version 1.3 or later.

Later software versions: *Additional parameters might be available* on the SINAMICS DCM (i.e. extra functions might be available which are not described in these Operating Instructions) or some parameters might have an extended setting range. In this case, leave the relevant parameters at their factory setting, or do not set any parameter values which are not described in these Instructions!

The latest software version of the SINAMICS DCM can be read in parameter r500060_0.

Contents

1	Safety information	1-1
2	Introduction	
2.1	Base Drive panel description	2-1
2.2	General information	2-1
2.3	Rated DC current	2-2
2.4	Expandable functionality using SINAMICS components	2-4
3	Parts and service	
3.1	Base Drive panel model numbers	3-1
3.2	Service	3-1
3.3	Option part numbers	3-2
3.4	Spare parts	3-2
4	Receiving and unpacking	4-1
5	Technical data	
5.1	15–125A DC Base Drive panels	5-1
5.2	210–1200A DC Base Drive panels	5-2
5.3	Applicable standards	5-4
6	Installation and dimensions	
6.1	Installation information	6-1
6.2	Base Drive panel outlines	6-2
7	Base Drive panel connections	
7.1	Base Drive panel schematics	7-2
7.2	Control connections control units (CUD)	7-13
7.3	Control units (CUD) installed	7-15
7.4	Description of power / control terminals	7-16

1 Safety information



WARNING



Hazardous voltages and moving parts are present in this electrical equipment during operation. Non-observance of the safety instructions can result in death, severe personal injury or substantial property damage.

Only qualified personnel should work on or around the equipment after first becoming thoroughly familiar with all warning and safety notices and maintenance procedures contained herein. The successful and safe operation of this equipment is dependent on proper handling, installation, operation and maintenance.

Definitions

QUALIFIED PERSONNEL

For the purpose of this Instruction Manual and product labels, a “Qualified Person” is someone who is familiar with the installation, construction and operation of the equipment and the hazards involved. He or she must have the following qualifications:

1. Trained and authorized to energize, de-energize, clear, ground and tag circuits and equipment in accordance with established safety procedures.
2. Trained in the proper care and use of protective equipment in accordance with established safety procedures.
3. Trained in providing first aid.

DANGER

For the purpose of this Instruction Manual and product labels, “**Danger**” indicates that death, severe personal injury or substantial property damage **will** result if proper precautions are not taken.

WARNING

For the purpose of this Instruction Manual and product labels, “**Warning**” indicates that death, severe personal injury or substantial property damage **can** result if proper precautions are not taken.

CAUTION

For the purpose of this Instruction Manual and product labels, “**Caution**” indicates that minor personal injury or property damage **can** result if proper precautions are not taken.

NOTE

For the purpose of this Instruction Manual, “**Note**” indicates information about the product or the respective part of the Instruction Manual which requires particular attention.

NOTE

These operating instructions do not purport to cover all details or variations in equipment, or to provide for every possible contingency to be met in connection with installation, operation or maintenance.

Should further information be desired or should particular problems arise which are not covered sufficiently for the purchaser's purposes, the matter should be referred to the local Siemens Sales Office.

The contents of these operating instructions shall not become part of or modify any prior or existing agreement, commitment or relationship. The Sales Contract contains the entire obligations of Siemens. The warranty contained in the contract between the parties is the sole warranty of Siemens. Any statements contained herein do not create new warranties or modify the existing warranty.



DANGER

Converters contain hazardous electrical voltages, Death, severe bodily injury or significant material damage can occur if the safety measures are not followed.

1. Only qualified personnel, who are knowledgeable about the converters and the provided information, can install, start up, operate, troubleshoot or repair the converters.
2. The converters must be installed in accordance with all relevant safety regulations (e.g. NEC, DIN, VDE) as well as all other national or local regulations. Operational safety and reliability must be ensured by correct grounding, cable sizing and appropriate short-circuit protection.
3. All panels and doors must be kept closed during normal operation.



4. Before carrying out visual checks and maintenance work, ensure that the AC power supply is disconnected and locked out. Before the AC supply is disconnected, both converters and motors have hazardous voltage levels. Even when the converter contactor is open, hazardous voltages are still present.
5. When making measurements with the power supply switched on, electrical connections must not be touched under any circumstances. Remove all jewelry from wrists and fingers. Ensure that the test equipment is in good condition and operationally safe.
6. When working on units that are switched on, stand on an insulating surface, i.e. ensure that you are not grounded.
7. Carefully follow the relevant instructions and observe all danger, warning and cautionary instructions.
8. This does not represent a full listing of all the measures necessary for safe operation of the equipment. If you require other information or if certain problems occur which are not handled in enough detail in the information provided in the Instruction Manual, please contact your local Siemens office.

1 Safety information (continued)



CAUTION Electro-statically sensitive devices

The converter contains electro-statically sensitive devices. These can easily be destroyed if they are not handled correctly. If, however, it is absolutely essential for you to work on electronic modules, please pay careful attention to the following instructions:

- Electronic modules (PCBs) should not be touched unless work has to be carried out on them.
- Before touching a PCB, the person carrying out the work must himself be electro-statically discharged. The simplest way of doing this is to touch an electrically conductive ground object, e.g. socket outlet ground contact.
- PCBs must not be allowed to come into contact with electrically insulating materials * plastic foil, insulating table tops or clothing made of synthetic fibers *
- PCBs may only be set down or stored on electrically conducting surfaces.
- When carrying out soldering jobs on PCBs, make sure that the soldering tip has been grounded.
- PCBs and electronic components should generally be packed in electrically conducting containers (such as metallized-plastic boxes or metal cans) before being stored or shipped.
- If the use of non-conducting packing containers cannot be avoided, PCBs must be wrapped in a conducting material before being put in them. Examples of such materials include electrically conducting foam rubber or household aluminum foil.

For easy reference, the protective measures necessary when dealing with sensitive electronic components are illustrated in the sketches below.

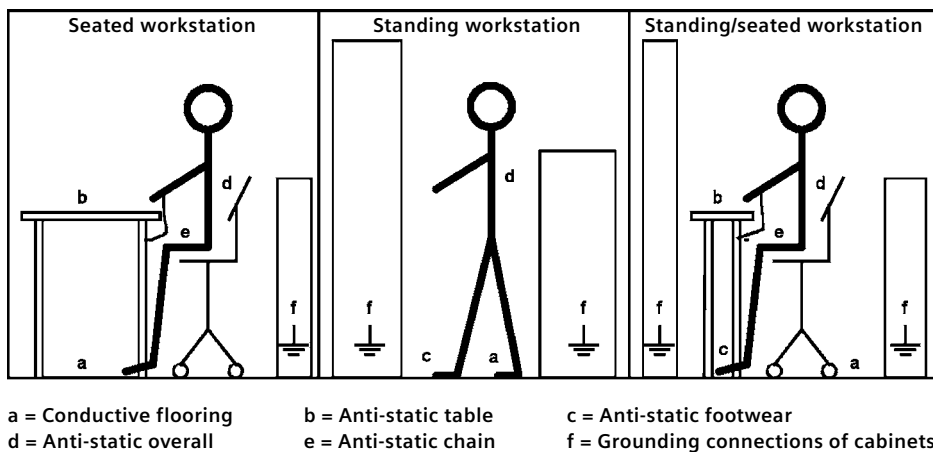

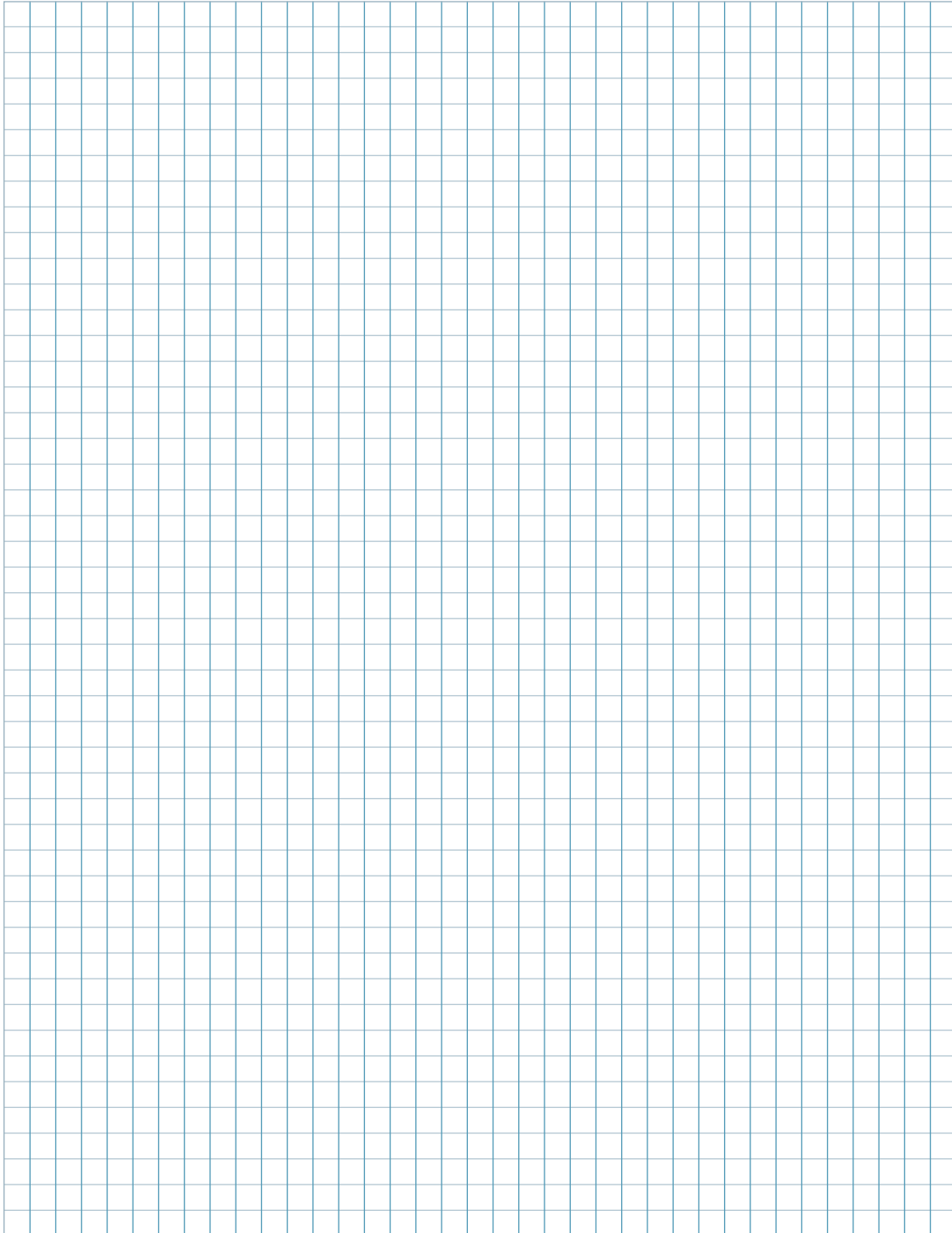

2 Introduction

2.1 Base Drive panel description

SINAMICS DCM Base Drive panels are complete drive assemblies ready to be installed into an enclosure. Base Drive Panels are fully digital, compact units which supply the armature and field of variable-speed DC motors with rated armature currents from 15 Amps to 1200 Amps. The motor field circuit can be supplied with DC currents of up to 40 Amps (current levels depend on the armature rated current). Each Base Drive panel includes the following components and factory installed converter options.

- 3-phase Armature Converter
- 1-phase Field Converter
- Main Contactor or DC Output Contactor (Frame Size Dependent)
- Protective Semiconductor Fuses (Frame Size Dependent since may be internal to converter)
- Control Power Transformer
- Power and Control Terminals
- Advanced CUD – G00 Option
- PROFINET, EtherNet/IP Communication CBE20 – G20 Option
- Micro Memory Card – S01 Option
- Single phase fan (230V AC) – L21 Option, 450A – 1200A Base Drives

Providing the Advanced CUD, provides several customer advantages.

- DRIVE-CLiQ connectivity allows for the connection of Terminal Modules (TM15, TM31, TM150) plus the SMC30 Encoder Module. This gives the customers flexibility for future expansion of additional Input/Outputs by simply adding DRIVE-CLiQ modules rather than adding another Advanced CUD board to add additional Inputs/Outputs.
- Option Slot allows the CBE20 to be installed in the Advanced CUD. The CBE20 allows the drive to utilize ProfiNet or Ethernet-IP communications. The CBE20 can alternatively be used to provide high speed peer to peer communications with the drives.

2.2 General information

SINAMICS DCM converters are characterized by their compact, space-saving construction. Their compact design makes them particularly easy to service and maintain since individual components are readily accessible.

All SINAMICS DCM units are equipped with a BOP20 “Basic operator panel” mounted in the converter cover. The BOP20 has a backlit two-line display area and 6 keys. It may be used to acknowledge faults, set parameters and read diagnostic information.

The AOP30 optional advance operator panel can be mounted externally, e.g., in the cubicle door. When mounted remotely, the AOP30 can be connected to the converter with cables up to 50 meters (164 feet) in length. Cables up to 200 meters (600 feet) in length can be used if a separate 24V DC power supply is available. The AOP30 connects to the SINAMICS DCM through connector X178 using the RS485 interface. The AOP30 can be installed as an economic alternative to conventional door mounted metering devices (i.e., voltmeters, ammeters, and speed indicator).

The AOP30 features a liquid crystal display (240 × 64 pixels) with backlighting for plain-text display and a bar-type display for process variables. English, German, French, Spanish, Italian and Chinese can be selected as the display languages.

The converter can also be parameterized on a standard PC with appropriate software connected to the serial interface on the basic unit. This PC interface is used during start-up, for maintenance during shutdown and for diagnosis in operation.

On 2-quadrant converters, a fully controlled three-phase bridge supplies the armature. On 4-quadrant converters, two fully controlled three-phase bridges are connected in an inverse-parallel connection to allow both positive and negative armature current. For the field converter, a single-phase, half-controlled 2-pulse bridge supplies the motor shunt field.

The armature and field converters can operate with AC line frequencies from 45–65 Hz. If required for a specific application, the frequency of the armature and field AC supplies can be different. The power section cooling system is monitored by means of temperature sensors.

The power section for the armature and field converters is constructed of isolated thyristor modules for converters rated from 15A–1200A at 480V AC line voltage. The heat sink in this case is electrically isolated and at ground potential. The housing and terminal covers on power connections provide protection against accidental contact for operators working in the vicinity. All connecting terminals are accessible from the top.

All open and closed-loop drive control and communication functions are performed by powerful microprocessors. Drive control functions are implemented in the software as program modules that can be “wired up” and changed by parameters.

2.3 Rated DC current

- The rating plate of the SINAMICS DCM Base drive panel has the rated Armature current listed of the output rating for IEC DC I constant duty rating.
- The Base Drive Panels are designed using the DC I rating which means that fuses, contactors and terminal blocks are sized for the full continuous DC I current.
- The DC I rating is the maximum current the power module can supply continuously with no overload. Because an overload is not possible, the DC I rated current is higher than the continuous DC II rating.
- The microprocessor calculates the current I2t value of the power section cyclically to ensure that the thyristors are not damaged in overload operation.
- The DC II rated current allows operation by an overload of 150% for 60 seconds in a 40° C ambient. The overload can be applied no sooner than every 15 minute intervals.

Overload capability

The rated DC current specified on the unit rating plate (maximum permissible continuous DC current) may be exceeded in operation. The extent to which this value is exceeded and how long this lasts are subject to certain limits. The absolute upper limit for the value of the overload currents is 1.8x the rated DC current. The maximum overload duration depends on the time characteristic of the overload current, as well as on the load history of the unit, and also depends on the specific unit. Each overload must be preceded by an under load (load phase with load current < rated DC current). Once the maximum permissible overload duration has elapsed, the load current must return to at least an absolute value ≤ the rated DC current. The SINAMICS DCM Base drive may be operated with five different overload settings configured in the drive parameters.

2 Introduction (continued)

DC I through DC IV rated at 40 °C

- **DC I** — Continuous Duty without no overloads possible
- **DC II** — Continuous rating with 150% overload for 60 seconds with a 15 minute cool down below base load current setting
- **DC III** — Continuous rating with 150% overload for 120 seconds with a 15 minute cool down below base load current setting
- **DC IV** — Continuous rating with 200% overload for 10 seconds with a 15 minute cool down below base load current setting
- **US Rated** — Continuous rating with 150% overload for 60 seconds with a 15 minute cool down below base load current setting — ambient temp at 45 °C

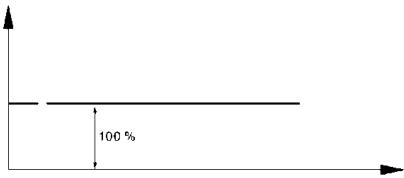
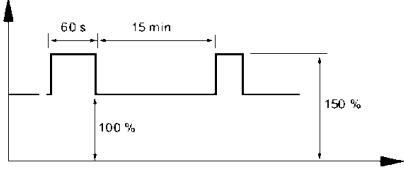
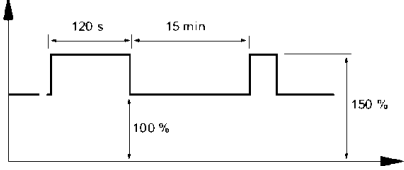
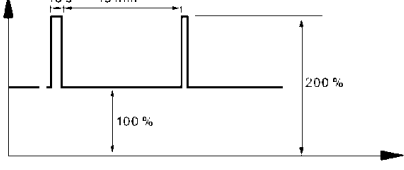
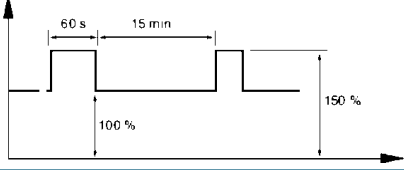
Load class (parameter)	Load for the converter	Load cycle
DC I	$I_{DC I}$ continuous (I_{dN})	
DC II	$I_{DC II}$ for 15 min. and $1.5 \times I_{DC II}$ for 60 s	
DC III	$I_{DC III}$ for 15 min. and $1.5 \times I_{DC III}$ for 120 s	
DC IV	$I_{DC IV}$ for 15 min. and $2 \times I_{DC IV}$ for 10 s	
U.S. rating	I_{US} for 15 min and $1.5 \times I_{US}$ for 60 s Note: with this setting, for all unit types, an ambient and / or cooling medium temperature of 45 °C is permissible.	

2.4 Expandable functionality using SINAMICS components

One of the many features of the SINAMICS DCM Base Drive is its ability to expand its functionality modularly through the use of coupling supplementary modules from the SINAMICS drives family to the DRIVE-CLiQ interface. Modules include digital, analog I/O, external encoder and communications options. As a result, the flexibility, when engineering the plant or system is increased, costs are optimized at the same time. A complete list of the option modules can be found in the SINAMICS DCM catalog available from your local Siemens sales office.

The SINAMICS DCM Base Drive contains one advanced CUD (left) microprocessor board with the CBE20 installed, and one additional bay for another advanced or standard CUD (right).

In order to optimally fulfill the requirements relating to interfaces and computational performance for technology functions, a standard or advanced CUD or a combination can be selected. It is also possible to use two CUDs to increase the performance for technological open-loop and closed-loop control tasks. This allows optimum adaptation to the wide range of requirements relating to drive technology and complementary markets — both technically and economically.

3 Parts and service

3.1 Base Drive panel catalog numbers

DC1 rating (Amps DC)	2-quad type (Catalog No.)	4-quad type (Catalog No.)	Horsepower (240V DC ¹)	Horsepower (500V DC)
15	N/A	6RA80132FV620AA0	3 HP	7.5 HP
30	N/A	6RA80182FV620AA0	7.5 HP	15 HP
60	6RA80252FS220AA0	6RA80252FV620AA0	15 HP	30 HP
90	6RA80282FS220AA0	6RA80282FV620AA0	20 HP	40 HP
125	6RA80312FS220AA0	6RA80312FV620AA0	30 HP	60 HP
210	6RA80752FS220AA0	6RA80752FV620AA0	50 HP	100 HP
280	6RA80782FS220AA0	6RA80782FV620AA0	75 HP	150 HP
450	6RA80822FS220AA0	6RA80822FV620AA0	100 HP	200 HP
600	6RA80852FS220AA0	6RA80852FV620AA0	150 HP	300 HP
850	6RA80872FS220AA0	6RA80872FV620AA0	200 HP	400 HP
1200	6RA80912FS220AA0	6RA80912FV620AA0	300 HP	600 HP

¹ All horsepower ratings above are calculated with the continuous rating used with (DC II) and 150% overload for one minute. *Amp ratings for the 6RA80 SINAMICS DCM Base Drive are based upon DC I ratings. No overload capability. Standard voltage configuration as shipped is 480V AC. See Technical application note for 240V AC connection.

NOTE

All SINAMICS DCM base drives are provided with the Advanced CUD and CBE20 cards installed. The CBE20 allows for Ethernet programming capability as standard. Take advantage of Siemens' progressive developments in Industrial Ethernet technology and open connectivity. With direct network connectivity to PROFINET, EtherNet/IP™ and standard Ethernet TCP/IP, SINAMICS base drives fit comfortably within your plant's network, providing you with maximum productivity and capacity planning.

3.2 Service

Spare parts

An excellent stock of drive products and spare parts are maintained at the distribution center in Southaven, Mississippi. Same day, after hour shipments can be serviced from this stock, including weekends and holidays.

To contact Customer Service, call our Customer Service Group Hotline:

1-888-454-4704

Technical assistance

Should you need technical assistance (other than ordering a part), a reliable answering service ensures that your request is relayed immediately to one of our technical support engineers 24-hours a day.

To contact the Technical Support and Field Service groups, simply call:

1-800-333-PIC1 (7421)

3.3 Option part numbers

Options	Order No.
Standard CUD coated in right slot (Possible with Advanced CUD in left)	6RY18030AA200AA1
Standard CUD	6RY18030AA000AA1
Advanced CUD coated in right slot (Possible with Advanced CUD in left)	6RY18030AA250AA1
Advanced CUD	6RY18030AA050AA1
Advance Operator Panel AOP30	6SL30550AA004CA5
RS485 connecting cable for connecting the AOP30 to one CUD; 3m	6RY18070AP00
RS485 connecting cable for connecting the AOP30 to two CUDs; 3m	6RY18070AP10
Sensor Module Cabinet-Mounted SMC30 (Incremental Encoder)	6SL30550AA005CA2
CBE20 PROFINET left (Possible with Advanced CUD in left)	6SL30550AA002E80
CBE20 PROFINET right (Possible with Advanced CUD in right)	6SL30550AA002E80
Terminal Module TM15	6SL30550AA003FA0
Terminal Module TM31	6SL30550AA003AA1
Terminal Module TM150	6SL30550AA003LA0

¹A pulse encoder evaluation circuit is a standard component of the basic SINAMICS DCM converter. The SM30 only needs to be ordered in configurations requiring evaluation of a second pulse encoder.

3.4 Spare parts

Cables

Description	Where used US rating 480V	Part number	Recommended spare
Ribbon cable Basic Operator Panel BOP20 (Allocation board A7126 -X111)	All Ratings	6RY18070AA00	1
Ribbon cable Power interface X108 (to Allocation board A7126 -X108)	15–850 Amp	6RY18070AA02	1
Ribbon cable Power interface X108 (to Allocation board A7126 -X108)	1200 Amp	6RY18070AA05	1
Ribbon cable Power interface -XF1 (Q4 Only)(to Field supply -XF1)	15–30 Amp	6RY18070AA01	1
Ribbon cable Power interface -XF1 (Q2 and Q4)(to Field supply -XF1)	60–280 Amp and 1200 Amp	6RY18070AA03	1
Ribbon cable Power interface -XF1 (Q2 and Q4)(to Field supply -XF1)	450–600 Amp	6RY18070AA04	1
Ribbon cable Power interface -XF1 (Q2 and Q4)(to Field supply -XF1)	850 Amp	6RY18070AA10	1

3 Parts and service (continued)

Printed circuit boards

Description	Where used US rating 480V	Part number	Recommended spare
Advanced CUD (C98043-A7100-L4)	All Ratings	6RY18030AA050AA1	1
Memory card (C98130-A7100-B1)	All Ratings	6RX18000AS01	1
Connector board (C98043-A7125-L1)	All Ratings	6RY18030GA00	1
Allocation board* (C98043-A7126-L1)	All Ratings	6RY18030GA01	1
Power Interface board (2Q Only) (C98043-A7105-L1)	All 2Q Ratings	6RY18030DA01	1
Power Interface board (4Q Only) (C98043-A7105-L4)	All 4Q Ratings	6RY18030DA02	1
Basic Operator Panel BOP20 (A5E00111019)	All Ratings	6SL30550AA004BA0	1
Field Supply/Power Section +RC (4Q Only) (C98043-A7111-L1)	15 Amp	6RY18030CA01	1
Field Supply/Power Section +RC (4Q Only) (C98043-A7111-L2)	30 Amp	6RY18030CA02	1
Field Supply board (2Q and 4Q) (C98043-A7120-L6)	60 to 125 Amp	6RY18030CA03	1
Field Supply board (2Q and 4Q) (C98043-A7115-L12)	210 to 850 Amp	6RY18030CA04	1
Field Supply board (2Q and 4Q) (C98043-A7116-L1)	1200 Amp	6RY18030CA05	1
Snubber board (RC) (C98 043-A7007-L4)	60 to 280 Amp	6RY18030FA05	1
Snubber board (RC) (C98043-A7011-L6)	450 and 600 Amp	6RY17030FA10	1
Snubber boards (RC) (C98043-A7011-L1)	850 Amp and 1200 Amp	6RY17030FA06	2
Fuse for Power Supply, 1 amp F1, F2 Mounted on Power Interface board	All Ratings	6RY17020BA00	2
Heat Sink Temperature Sensor (C98 043-A7010-L2)	All Ratings	6RY18060AB00	1

*When ordering please indicate the units order No. (MLFB) and Serial Number.

Fans / blowers

Description	Where used US rating 480V	Part number	Recommended spare
FAN, 24V DC (2Q and 4Q)	210 to 280 Amp	6RY18010AA01	2
FAN, 230V AC, 1-phase (2Q and 4Q)	450 to 850 Amp	6RY18010AA20	1
FAN, 230V AC, 1-phase (2Q and 4Q)	1200 Amp	6RY18010AA21	1

Thyristors and diodes

Armature converter thyristor modules, (for 2-quad drives)

Description	Where used US rating 480V	Part number	Recommended spare
Dual Thyristor Module (MCC44-18IO8B)	60 Amp	6RY17000AA17	3
Dual Thyristor Module (SKKT72/16E)	90 Amp	6RY17000AA18	3
Dual Thyristor Module (SKKT106/16EH1)	125 Amp	6RY17000AA11	3
Dual Thyristor Module (SKKT122/16E)	210 Amp	6RY17000AA14	3
Dual Thyristor Module (TT162N16-KOF)	280 Amp	6SY70100AA02	3
Dual Thyristor Module (MCC170-16IO1)	450 Amp	6RY18000AA01	3
Dual Thyristor Module (MCC312-16IO1)	600 Amp	6SY70100AA05	3
Dual Thyristor Module (TT500N16-KOF)	850 Amp	6SY70100AA04	3
Dual Thyristor Module (T2600N16)	1200 Amp	6RY18000AA03	6

Armature converter thyristor modules, (for 4-quad drives)

Description	Where used US rating 480V	Part number	Recommended spare
Dual Thyristor Module (MCC44-18IO8B)	60 Amp	6RY17000AA17	6
Dual Thyristor Module (SKKT106/16EH1)	90 Amp	6RY17000AA11	6
Dual Thyristor Module (SKKT106/16EH1)	125 Amp	6RY17000AA11	6
Dual Thyristor Module (SKKT122/16E)	210 Amp	6RY17000AA14	6
Dual Thyristor Module (TT162N16-KOF)	280 Amp	6SY70100AA02	6
Dual Thyristor Module (MCC170-16IO1)	450 Amp	6RY18000AA01	6
Dual Thyristor Module (MCC312-16IO1)	600 Amp	6SY70100AA05	6
Dual Thyristor Module (TT500N16-KOF)	850 Amp	6SY70100AA04	6
Dual Thyristor Module (TT570N16)	1200 Amp	6RY17000AA04	6

¹ For 4 Quad 15 and 30 Amp models the Armature and Field Circuit Thyristors are incorporated into the Field Supply/Power Section +RC, PCB.

3 Parts and service (continued)

Field converter thyristor modules

Description	Where used US rating 480V	Part number	Recommended spare
Dual Thyristor Module (MCC21-16IO8B)	60–600 Amp	6RY17000AA12	1
Dual Thyristor Module (MCC44-18IO8B)	850 Amp and 1200 Amp	6RY17000AA17	1

Field converter diode modules

Description	Where used US rating 480V	Part number	Recommended spare
Dual Diode Module (SKKD46/16)	60–600 Amp	6RY17000BA04	1
Dual Diode Module (MDD44-16N1B)	850 Amp and 1200 Amp	6RY17000BA01	1

Power fuses

Armature converter AC line fuses, (1PFU, 2PFU, 3 PFU)

Description	Where used DC1 rating 480V	Part number	Recommended spare
35 Amp, 500 Volt	15 Amp	FWH-35B	3
35 Amp, 500 Volt	30 Amp	FWH-35B	3
60 Amp, 500 Volt	60 Amp	FWH-60B	3
100 Amp, 500 Volt	90 Amp	FWH-100B	3
125 Amp, 500 Volt	125 Amp	FWH-125B	3
225 Amp, 500 Volt	210 Amp	FWH-225A	3
300 Amp, 500 Volt	280 Amp	FWH-275A	3
450 Amp, 500 Volt	450 Amp	FWH-450A	3
600 Amp, 500 Volt	600 Amp	FWH-600A	3
800 Amp, 500 Volt	850 Amp	FWH-800A	3
¹ 800 Amp, 800 Volt	1200 Amp	3NE338-8	6
¹ 1200 Amp unit fuses are internal to the DCM Power module and are marked F1 thru F6.			

Armature converter DC fuses, 4-quad only (4PFU)

Description	Where used DC1 rating 480V	Part number	Recommended spare
35 Amp, 700 Volt	15 Amp	FWP-35B	2
35 Amp, 700 Volt	30 Amp	FWP-35B	2
70 Amp, 700 Volt	60 Amp	FWP-70B	2
125 Amp, 700 Volt	90 Amp	FWP-125A	2
150 Amp, 700 Volt	125 Amp	FWP-150A	2
250 Amp, 700 Volt	210 Amp	FWP-250A	2
350 Amp, 700 Volt	280 Amp	FWP-350A	2
500 Amp, 700 Volt	450 Amp	FWP-500A	2
700 Amp, 700 Volt	600 Amp	FWP-700A	2
1000 Amp, 700 Volt	850 Amp	FWP-1000A	2

Field converter AC line fuses (1FSU, 2FSFU)

Description	Where used DC1 rating 480V	Part number	Recommended spare
5 Amp, 700 Volt	15 and 30 Amp	FWP-5B	2
15 Amp, 700 Volt	60–125 Amp	FWP-15B	2
20 Amp, 700 Volt	210 and 280 Amp	FWP-20B	2
30 Amp, 700 Volt	450 and 600 Amp	FWP-30B	2
35 Amp, 700 Volt	850 Amp	FWP-35B	2
50 Amp, 700 Volt	1200 Amp	FWP-50B	2

Control transformer primary fuses (1CFU, 2CFU)

Description	Where used DC1 rating 480V	Part number	Recommended spare
1.25 Amp, 600 Volt, Class "CC"	15–125 Amp	FNQ-R-1-1/4	2
2.50 Amp, 600 Volt, Class "CC"	210, 280 Amp	FNQ-R-2-1/2	2
3.50 Amp, 600 Volt, Class "CC"	450 to 1200 Amp	FNQ-R-3-1/2	2

3 Parts and service (continued)

Control transformer secondary fuse (3CFU)

Description	Where used DC1 rating 480V	Part number	Recommended spare
0.75 Amp, 250V, Type MDL	15–125 Amp	FNQ-R-3/4	2
1-6/10 Amp, 250V, Type FNM	210, 280 Amp	FNM-1-6/10	2
2.00 Amp, 250V, Type MDL	450–850 Amp	MDL-2	2
6.25 Amp, 250V, Type MDL	1200 Amp	MDL-6-1/4	2

Control transformer (1CTR)

Description	Where used DC1 rating 480V	Part number	Recommended spare
115 VA, 240V AC secondary	15–125 Amp	A1TRCQ0C285	–
250 VA, 240V AC secondary	210, 280 Amp	A1TRCQ0C286	–
350 VA, 240V AC secondary	450–850 Amp	A1TRCQ0C287	–
1000 VA, 240V AC secondary	1200 Amp	A1TRCQ0C288	–

Main contactor (M)

Description	Where used DC1 rating 480V	Part number	Recommended spare
3-pole AC contactor, 240V AC coil	15 Amp	3RT10251AP60	–
3-pole AC contactor, 240V AC coil	30 Amp	3RT10331AP60	–
3-pole AC contactor, 240V AC coil	60 Amp	3RT10361AP60	–
3-pole AC contactor, 240V AC coil	90 Amp	3RT10451AP60	–
3-pole AC contactor, 240V AC coil	125 Amp	3RT10546AP36	–
3-pole AC contactor, 240V AC coil	210 Amp	3RT10566AP36	–
3-pole AC contactor, 240V AC coil	280 Amp	3RT10656AP36	–
3-pole AC contactor, 240V AC coil	450 Amp	3RT10756AP36	–
3-pole AC contactor, 240V AC coil	600 Amp	3RT10766AP36	–
3-pole AC contactor, 240V AC coil	850 Amp	40NH32AF	–
1-pole DC contactor, 240V DC coil	1200 Amp	A1CRDCAC010	–

Auxiliary contact block (MAUX)

Description	Where used DC1 rating 480V	Part number	Recommended spare
S0 to S12, 2-NO and 2-NC	15–600 Amp	3RH19211FA22	–

Contacting coil suppressor (1SP) (ENSP)

Description	Where used DC1 rating 480V	Part number	Recommended spare
Suppressor, varistor type 127 — 240V	15–125 Amp	3RT19261BD00	–
Suppressor, varistor type 127 — 240V	210–600 Amp	3RT19561CD00	–
Suppressor, varistor type 127 — 240V	1200 Amp	3RT19161BDC0	–

4 Receiving, unpacking

SINAMICS DCM Base Drive panels are packed at the manufacturing plant in protective containers suitable for shipping. Avoid dropping and shocks during unloading and moving the SINAMICS DCM Base Drive during receiving. Observe the instructions on the package for transport, storage, and correct handling.

If you discover the SINAMICS DCM Base Drive panel has been damaged during shipment, please inform your shipping agent immediately.



WARNING



If a SINAMICS DCM Base Drive panel was damaged during transport, it must not be connected up without first being repaired and tested by a qualified repair person.

Non-observance of the safety instructions can result in death, severe personal injury or substantial property damage.

Only qualified personnel should work on or around the equipment after first becoming thoroughly familiar with all warning and safety notices and maintenance procedures contained herein. The successful and safe operation of this equipment is dependent on proper handling, installation, operation and maintenance.

Procedure for shipping damage

SINAMICS DCM Base Drive panels are normally shipped FOB factory making it the buyer's responsibility to make sure the equipment is received undamaged. Carefully examine the equipment before accepting the shipment from the transport carrier. If you do not notify the carrier immediately of any damage you may lose your right to file a damage claim. If required, you can request support from the local Siemens office.

- When received, examine the shipment to ensure that it is complete and not damaged.
- Damaged or missing items that are obviously visible should be specified in the shipping papers and must be countersigned by personnel from the transport company.
- Immediately notify the transport company in writing of any damage or missing items.

A large grid of graph paper for taking notes, consisting of 20 columns and 30 rows of small squares.

5 Technical data

5.1 15, 30 ADC (4Q Only) and 60–125A DC (2 and 4Q)

Base Drive panels, 3-phase AC 480V

Rated supply voltage armature ¹⁾	V	3-phase 480 (+10% / – 20%)				
Rated input current armature + field ²⁾	A	12	25	50	75	104
Rated supply voltage field	V	1-phase 480 (+10% / – 20%)				
Rated frequency	Hz	45–65 Hz self-adapting (armature and field are independent)				
Rated DC voltage ³⁾	V	500				
Rated DC armature current (DCI)	A	15 (4Q)	30 (4Q)	60	90	125
Overload capability for 60s (DC II) ⁷⁾		150% of rated DC armature current				
Rated output @ 500V DC	Hp	7.5	15	30	40	60
Rated output @ 240V DC	Hp	3	7.5	15	20	30
Power loss at rated DC current (approximate)	kW	0.13	0.19	0.30	0.38	0.43
Rated DC voltage field	V	390 Max.				
Rated DC field current	A	3	5	10		
Operational ambient temperature	°C	0–45 at I _{rated} (self-cooled) ⁴⁾				
Storage and transport temperature	°C	– 40 to +70				
Installation altitude above sea level		≤ 1000 m at rated DC current ⁵⁾				
Control stability		$\Delta n = 0.006\%$ of the rated motor speed, valid for pulse encoder operation and digital setpoint $\Delta n = 0.1\%$ of the rated motor speed, valid for analog tachometer or analog setpoint ⁶⁾				
Degree of protection		Open Chassis (IP00)				
Dimensions		Refer to dimension drawings in Section 6				
Weights (approx.)	Lbs.	60	65	70	85	105

^{x)} Explanation at end of list of tables

5.2 210–1200A DC (2 and 4Q)

Base Drive panels, 3-phase AC 480V

Rated supply voltage armature ¹⁾	V	3-phase 480 (+10% / – 20%)					
Rated input current armature + field ²⁾	A	174	232	374	498	706	996
Fan type	V	Internal 24V DC			1-phase 240V		
Air flow rate	M ³ /h	300			600		1000
Fan noise level	dB(A)	52.4			64.5		74.2
Rated supply voltage field	V	1-phase 480 (+10% / – 20%)					
Rated frequency	Hz	45–65 Hz self-adapting (armature and field are independent)					
Rated DC voltage ³⁾	V	500					
Rated DC armature current (DC I)	A	210	280	450	600	850	1200
Overload capability for 60s (DC II) ⁷⁾		150% of rated DC armature current					
Rated output @ 500V DC	Hp	100	150	200	300	400	600
Rated output @ 240V DC	Hp	50	75	100	150	200	300
Power loss at rated DC current (approximately)	kW	0.72	0.81	1.58	1.91	2.60	4.24
Rated DC voltage field	V	390 Max.					
Rated DC field current	A	15		25		30	40
Operational ambient temperature	°C	0–40 at I _{rated} (fan-cooled) ⁴⁾					
Storage and transport temperature	°C	– 40 to +70					
Installation altitude above sea level		≤ 1000 m at rated DC current ⁵⁾					
Control stability		$\Delta n = 0.006\%$ of the rated motor speed, valid for pulse encoder operation and digital setpoint $\Delta n = 0.1\%$ of the rated motor speed, valid for analog tachometer or analog setpoint ⁶⁾					
Degree of protection		Open Chassis (IP00)					
Dimensions		Refer to dimension drawings in Section 6					
Weights (approx.)	Lbs.	130	150	250	275	350	470

^{x)} Explanation at end of list of tables

5 Technical data (continued)

Notes

- 1) Operation with reduced input voltage will result in reduced maximum output voltage accordingly.
- 2) Values apply for rated DC output current on both the armature and field circuits.
- 3) The specified output DC voltage can be guaranteed up to an undervoltage of 5% of rated line voltage.
- 4) The table below gives load values, (DC current), as a function of ambient temperature surrounding the SINAMICS DCM Base Drive panel.

IMPORTANT

When SINAMICS DCM Base Drive panels are installed into enclosures, make sure the temperature inside does not exceed the (Operational Ambient Temperature) rating of 40 or 45° C depending on the unit size, otherwise de-rate the DC current rating per the table below.

Ambient temperature	% reduction in base drive dc ampere rating	
	Self-cooled converters (15, 30, 60, 90, 125A DC)	Fan-cooled converters (210–1200A DC)
+40° C	– 0 %	– 0 %
+45° C	– 0 %	– 0 %
+50° C	– 6 %	– 10 % a)
+55° C	– 12 %	N/A

a) Operation of fan cooled units at ambients above 50°C is not permitted because of limitations on the allowable fan operating

- 5) Load values, (DC current), as a function of installation altitude.

Maximum permissible load of the DC converter in continuous operation (the load is specified as a % of the rated DC current)										
Installation altitude above sea level (the derating factors for values in between can be determined using linear interpolation)										
Ambient or coolant temperature	1000 m		2000 m		3000 m		4000 m		5000 m	
	Units up to 125 A	Units from 210 A and higher	Units up to 125 A	Units from 210 A and higher	Units up to 125 A	Units from 210 A and higher	Units up to 125 A	Units from 210 A and higher	Units up to 125 A	Units from 210 A and higher
30° C	100%		98%		96%	88%	86%	78%	78%	70%
35° C	100%		93%		90%	83%	80%	73%		
40° C	100%		94%	88%	84%	78%				
45° C	100%		95%	88%	83%					
50° C	94%	90%	82%	78%						
55° C	88%									

Voltage de-rating:

The units can be operated up to an installation altitude of 4,000 m above sea level with the specified rated supply voltages. Line supply voltages may have overvoltage category III with respect to ground. For installation altitudes above 4,000 m, in some cases, it will be necessary to reduce the supply voltage or ensure that overvoltage category II is maintained.

6) Requirements to achieve control stability

The control stability (closed-loop PI control) is referred to the rated motor speed and applies when the SINAMICS DCM is in the warm operating condition. This is based upon the following pre-conditions:

- Temperature changes of $\pm 10^{\circ}$ K.
- Line voltage changes corresponding to +10% / – 5% of the rated input voltage.
- Temperature coefficient of the tachometer generator with temperature compensation 0.15‰ every 10 °K (for analog tachometer generators only).
- Constant set point (14-bit resolution).
- Motor, load and encoder are correctly aligned and the load is balanced.

7) Details of overload capability

Following operation at rated load, SINAMICS DCM Base Drive panels are capable of carrying 150% of rated load for 1 minute, followed by a period of light load operation of such duration that the RMS load does not exceed rated continuous current. SINAMICS DCM Base Drive panels are designed for operation with heatsink air inlet temperatures up to 40 or 45°C depending on the unit size as stated above.

5.3 Applicable standards

- UL508A
- National Electrical Code

6 Installation and dimensions

6.1 Installation information

SINAMICS DCM Base Drive panels are designed as chassis units intended to be mounted inside a protective enclosure or inside a control room. The units are to be mounted vertically in cubicles usually with the power connections at the top and the control connections at the bottom. A minimum 100-mm (4-inch) clearance must be kept above and below the converter in order to ensure unrestricted cooling airflow. The open chassis units are designed to operate in a 45°C (15 to 125 Amp units) and 40°C ambient (210 to 1200 Amp units). When enclosed in a cubicle the ambient temperature outside the cubicle should not exceed 40°C, which then allows for a 5°C-temperature rise inside the cubicle. Care must be taken in the selection of the cubicle so that the internal temperature rise does not exceed 5°C. Refer to section 5 for approximate system de-rating data.

Note, Important: This equipment is designed and package-protected to handle the normal shock and vibration typically encountered in shipment. **Do not install these SINAMICS DCM Base Drive panels on equipment subject to shock or vibration. Select a reasonably clean location for installation, free from corrosive or conductive materials or fumes.**



CAUTION

Failure to lift the SINAMICS DCM Base Drive panel in the correct manner can result in bodily injury and/or property damage.

The SINAMICS DCM Base Drive panel must be lifted using suitable equipment and under the instruction of appropriately qualified personnel.

The user is responsible for installing the SINAMICS DCM Base Drive panel, motor, transformer as well as other equipment according to safety regulations (e.g. NEC), as well as all other relevant national or local regulations regarding cable sizing and protection, grounding, disconnects, overcurrent protection, etc.



The SINAMICS DCM Base Drive panels must be installed in accordance with the relevant safety regulations (e.g. NEC), as well as all other relevant national and local regulations. It must be ensured that the grounding, cable sizing and appropriate short-circuit protection have been implemented to guarantee operational safety and reliability.

Note, Important: SINAMICS DCM Base Drive panels have high-speed semiconductor fuses installed for protection of the thyristors in the event high fault currents are encountered. These fuses are "special purpose" fuses, and do not meet the requirements of the NEC for short-circuit protection in motor branch circuits. It is necessary to provide other devices for short-circuit protection. Typically molded case circuit breakers or NEC style fuses are used for this purpose. Refer to applicable sections of the NEC for additional information.



CAUTION

The fundamental principles of EMC in Section 6.1 of SINAMICS DCM Converter operating instructions (Order # C98130A7066A1047619) must be adhered to when installing any unit.



6.2 Base Drive panel outlines

Dimensions are mm (inches) 15 Amp panel (4Q only)

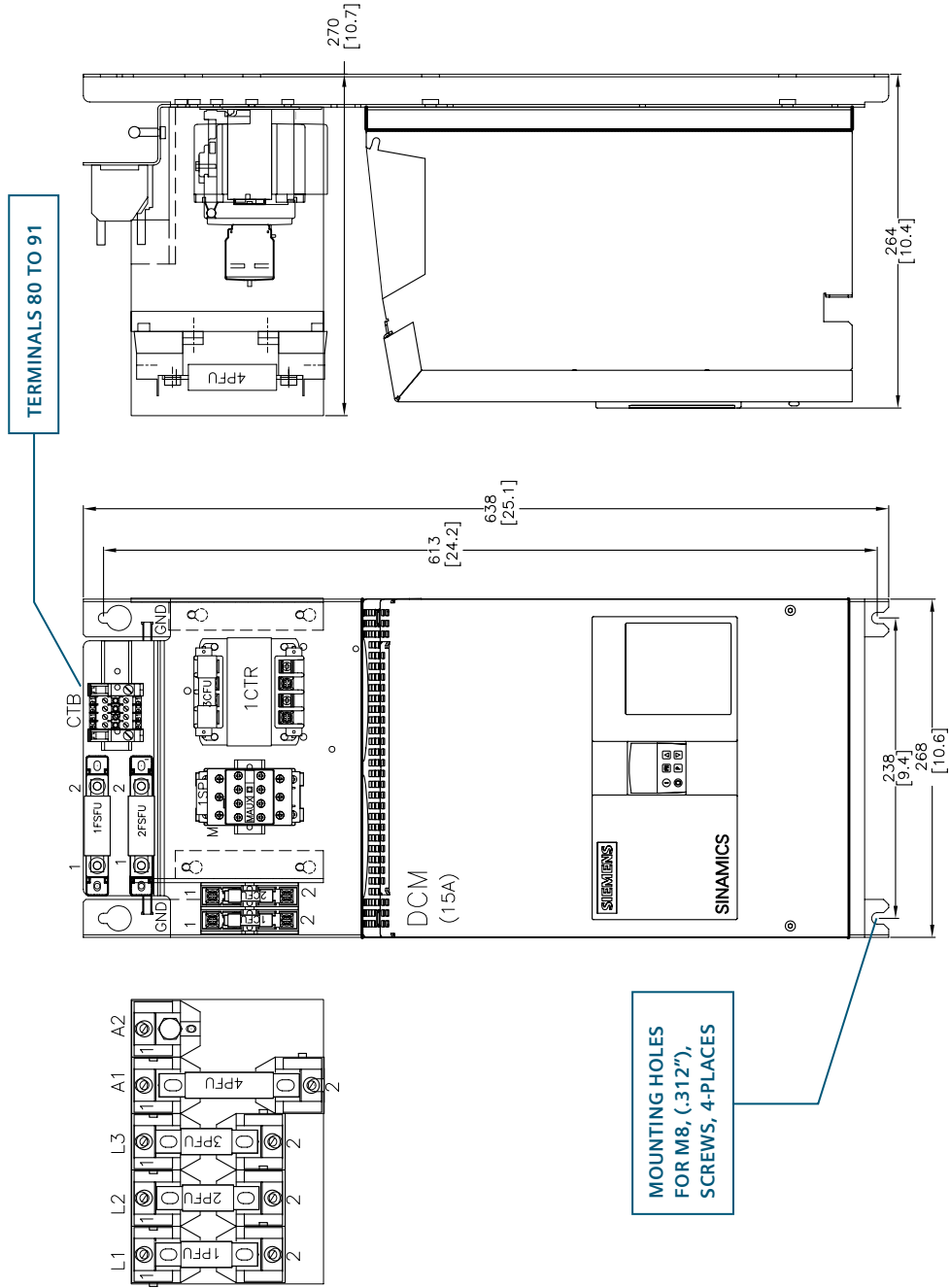

IMPORTANT NOTE: ALLOW AT LEAST 100 MILLIMETERS, (4'') OF CLEARANCE ABOVE AND BELOW THE UNIT TO ENSURE UNRESTRICTED AIR FLOW, ADDITIONAL CLEARANCE MAY BE REQUIRED TO ALLOW FOR WIRE OR CABLE ENTRY/EXIT AND BENDING. REFER TO APPLICABLE CODES FOR FURTHER INFORMATION.

6 Installation and dimensions (continued)

Dimensions are mm (inches) 30 Amp panel (4Q only)

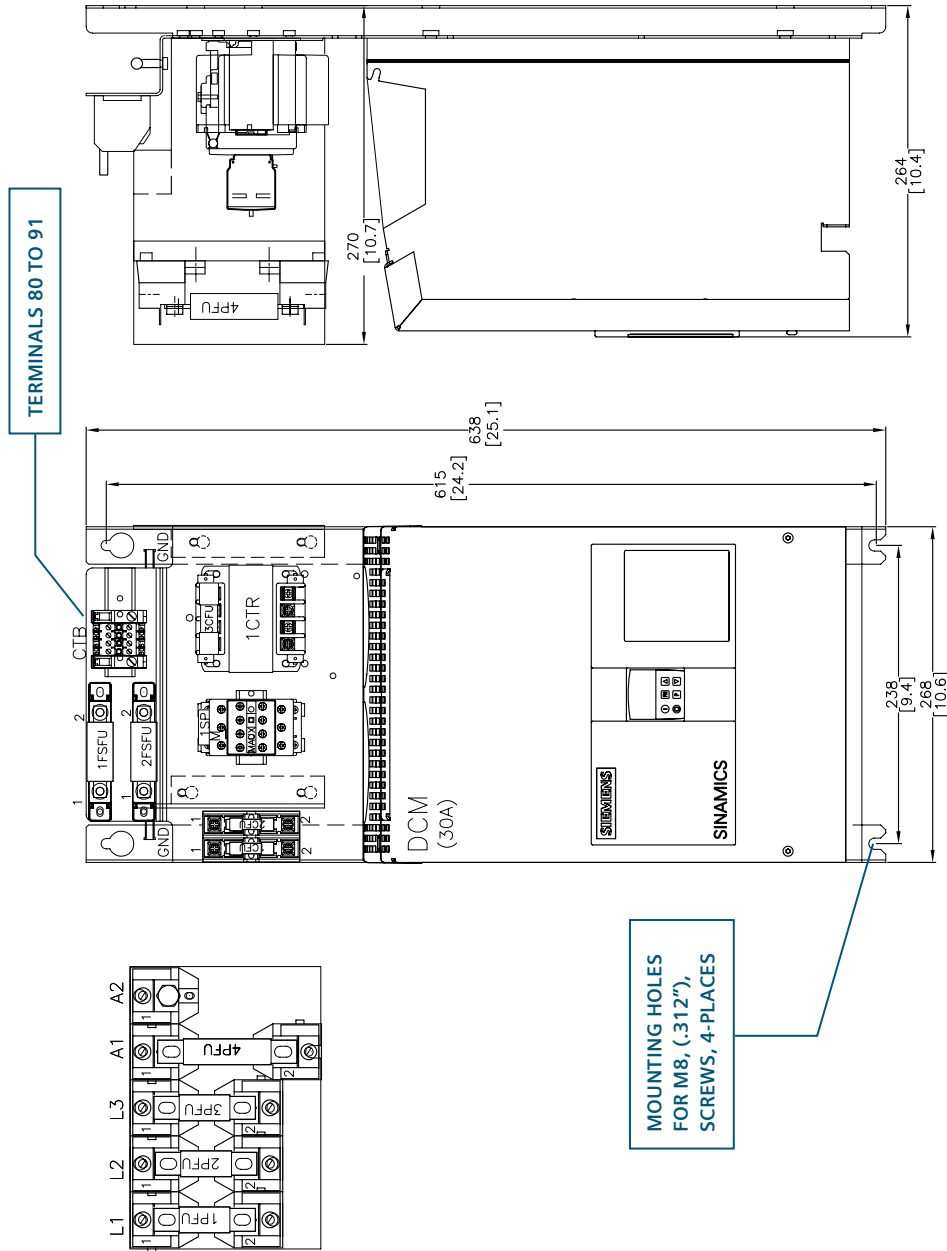

IMPORTANT NOTE: ALLOW AT LEAST 100 MILLIMETERS, (4") OF CLEARANCE ABOVE AND BELOW THE UNIT TO ENSURE UNRESTRICTED AIR FLOW, ADDITIONAL CLEARANCE MAY BE REQUIRED TO ALLOW FOR WIRE OR CABLE ENTRY/EXIT AND BENDING. REFER TO APPLICABLE CODES FOR FURTHER INFORMATION.

Dimensions are mm (inches) 60 Amp panel (2 and 4Q)

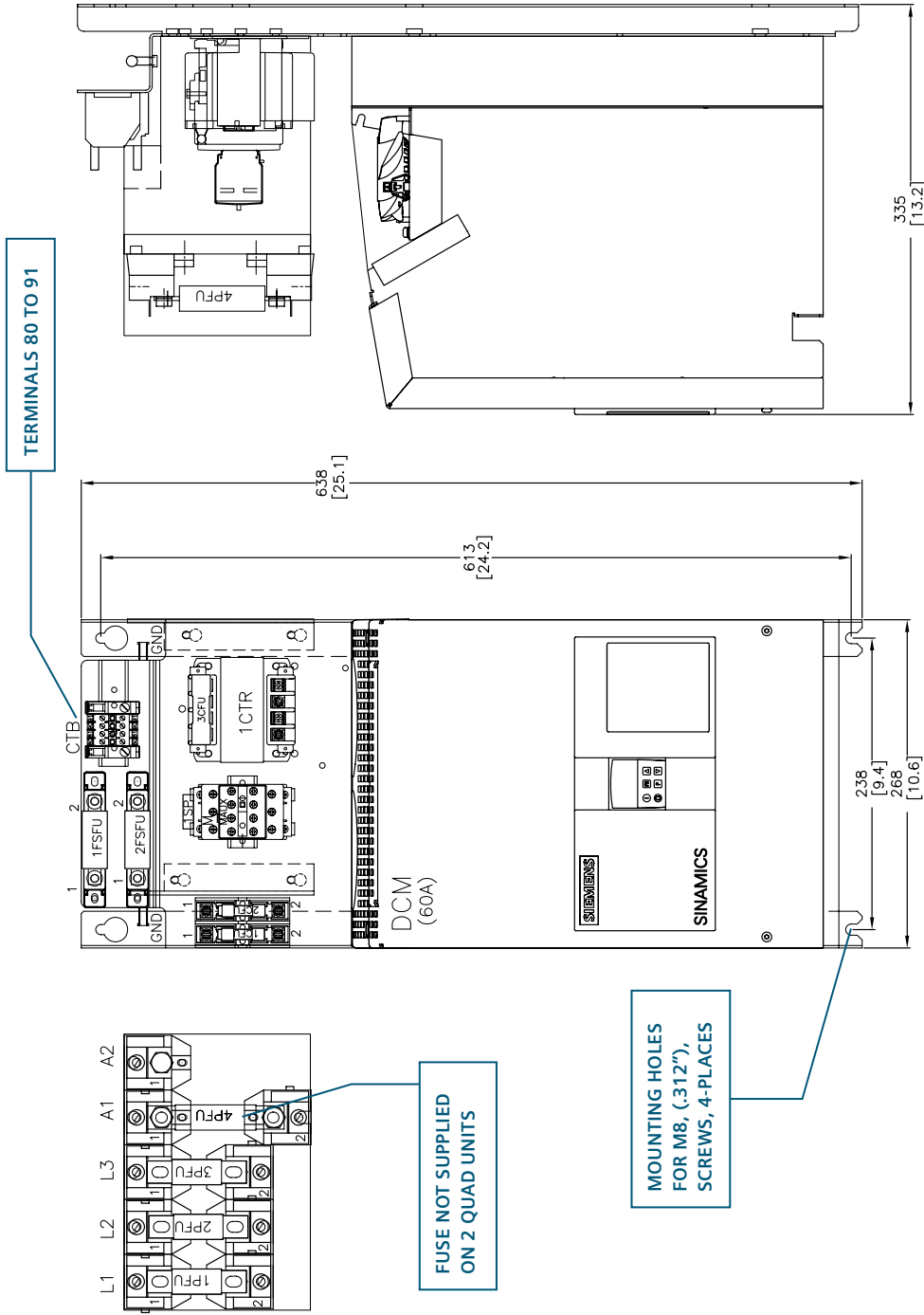

IMPORTANT NOTE: ALLOW AT LEAST 100 MILLIMETERS, (4") OF CLEARANCE ABOVE AND BELOW THE UNIT TO ENSURE UNRESTRICTED AIR FLOW, ADDITIONAL CLEARANCE MAY BE REQUIRED TO ALLOW FOR WIRE OR CABLE ENTRY/EXIT AND BENDING. REFER TO APPLICABLE CODES FOR FURTHER INFORMATION.

6 Installation and dimensions (continued)

Dimensions are mm (inches) 90 Amp panel (2 and 4Q)

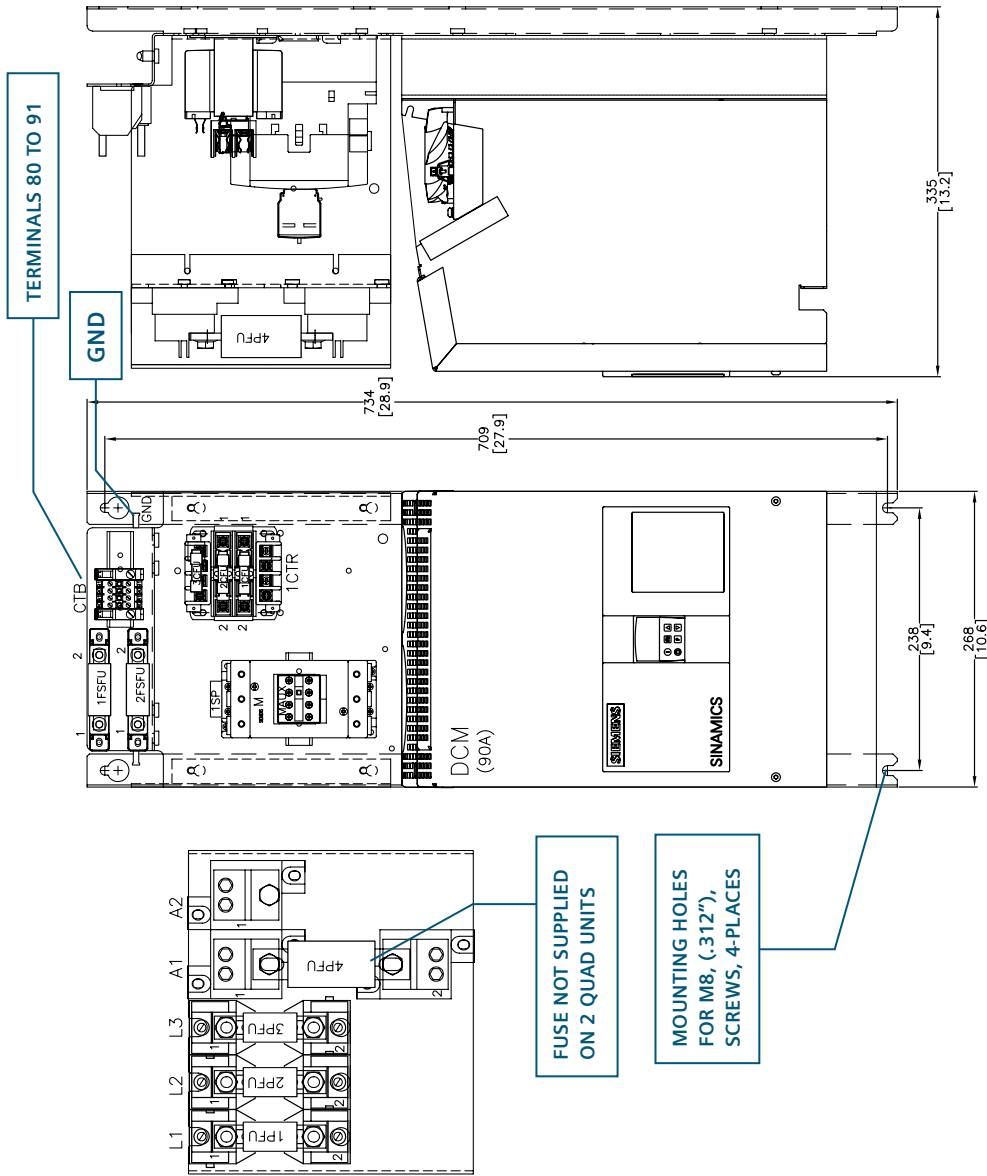

IMPORTANT NOTE: ALLOW AT LEAST 100 MILLIMETERS, (4") OF CLEARANCE ABOVE AND BELOW THE UNIT TO ENSURE UNRESTRICTED AIR FLOW, ADDITIONAL CLEARANCE MAY BE REQUIRED TO ALLOW FOR WIRE OR CABLE ENTRY/EXIT AND BENDING. REFER TO APPLICABLE CODES FOR FURTHER INFORMATION.

Dimensions are mm (inches) 125 Amp panel (2 and 4Q)

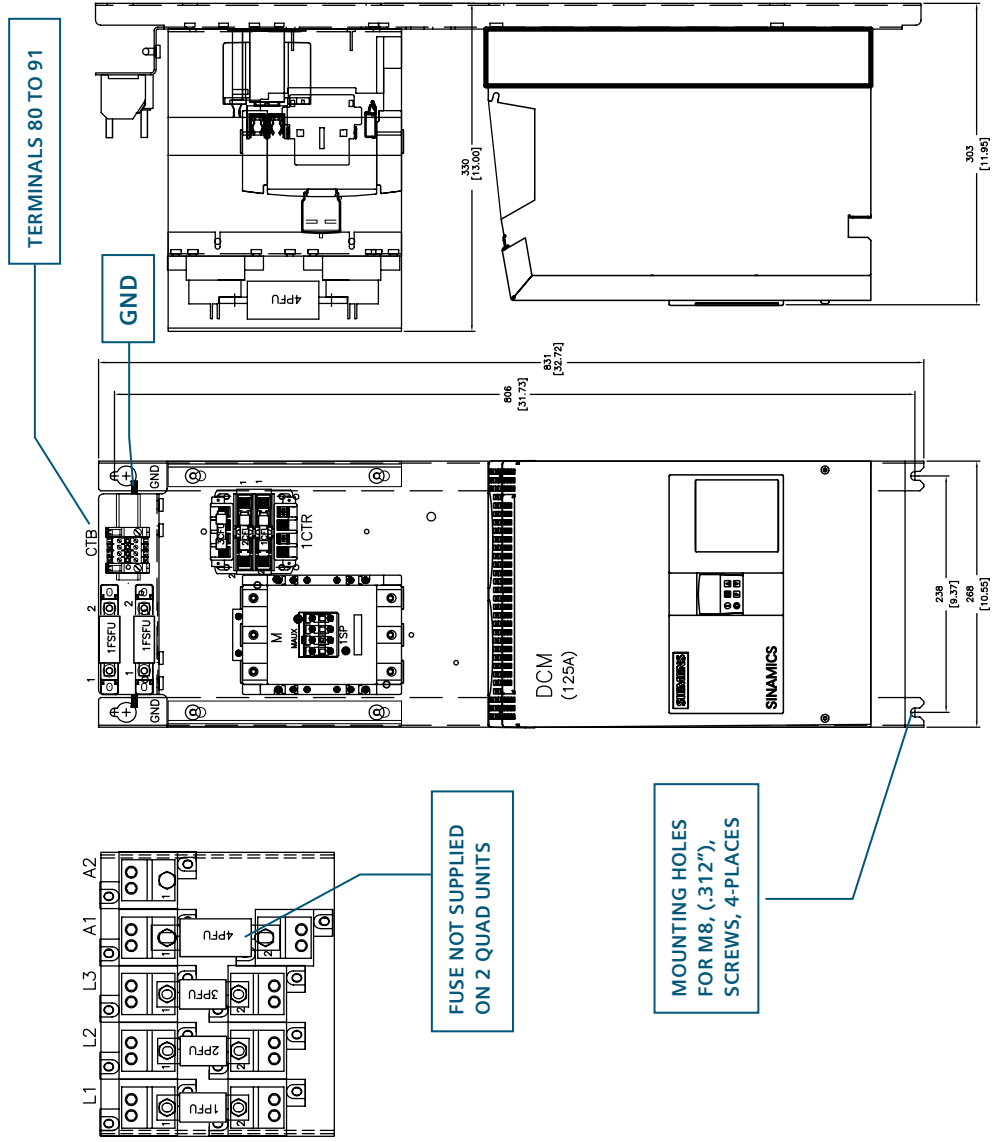

IMPORTANT NOTE: ALLOW AT LEAST 100 MILLIMETERS, (4") OF CLEARANCE ABOVE AND BELOW THE UNIT TO ENSURE UNRESTRICTED AIR FLOW, ADDITIONAL CLEARANCE MAY BE REQUIRED TO ALLOW FOR WIRE OR CABLE ENTRY/EXIT AND BENDING. REFER TO APPLICABLE CODES FOR FURTHER INFORMATION.

6 Installation and dimensions (continued)

Dimensions are mm (inches) 210 Amp panel (2 and 4Q)

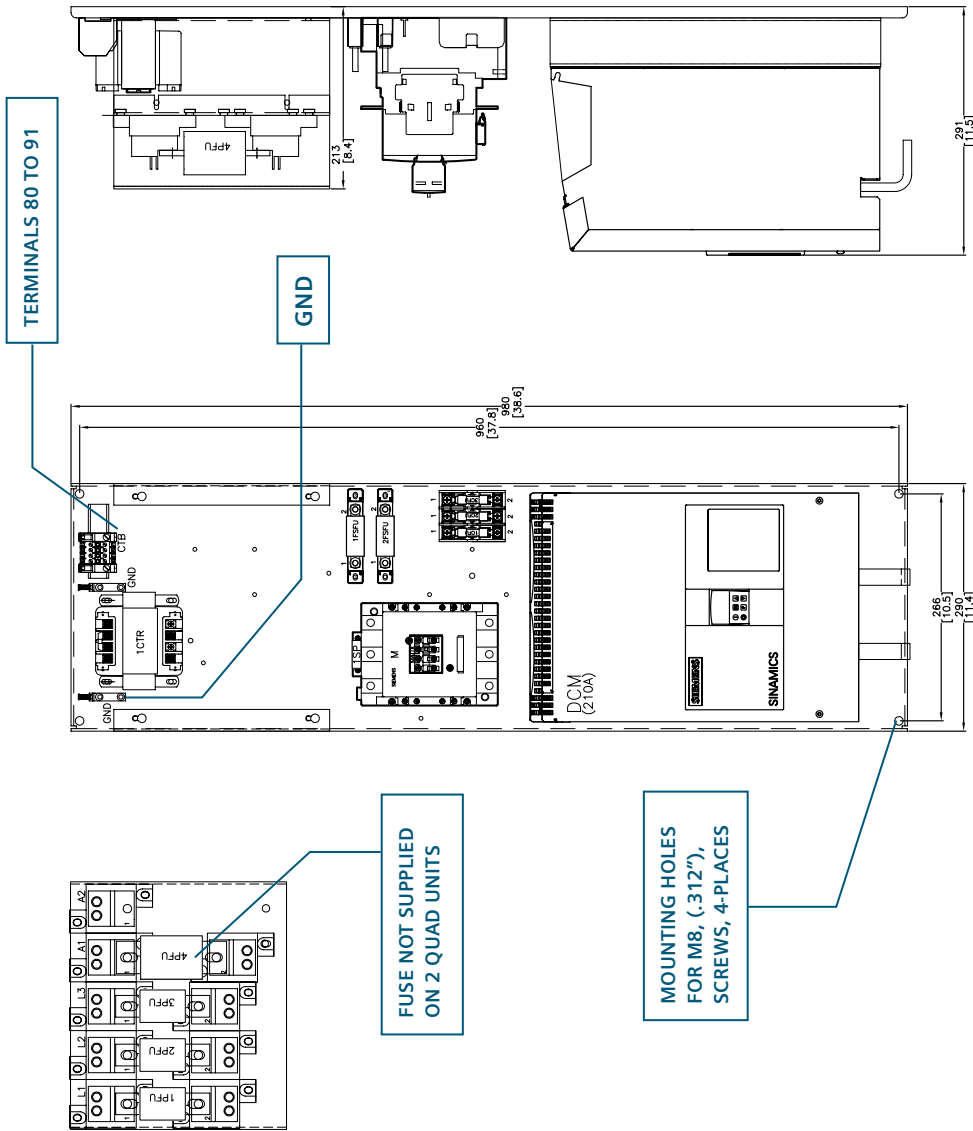

IMPORTANT NOTE: ALLOW AT LEAST 100 MILLIMETERS, (4") OF CLEARANCE ABOVE AND BELOW THE UNIT TO ENSURE UNRESTRICTED AIR FLOW, ADDITIONAL CLEARANCE MAY BE REQUIRED TO ALLOW FOR WIRE OR CABLE ENTRY/EXIT AND BENDING. REFER TO APPLICABLE CODES FOR FURTHER INFORMATION.

Dimensions are mm (inches) 280 Amp panel (2 and 4Q)

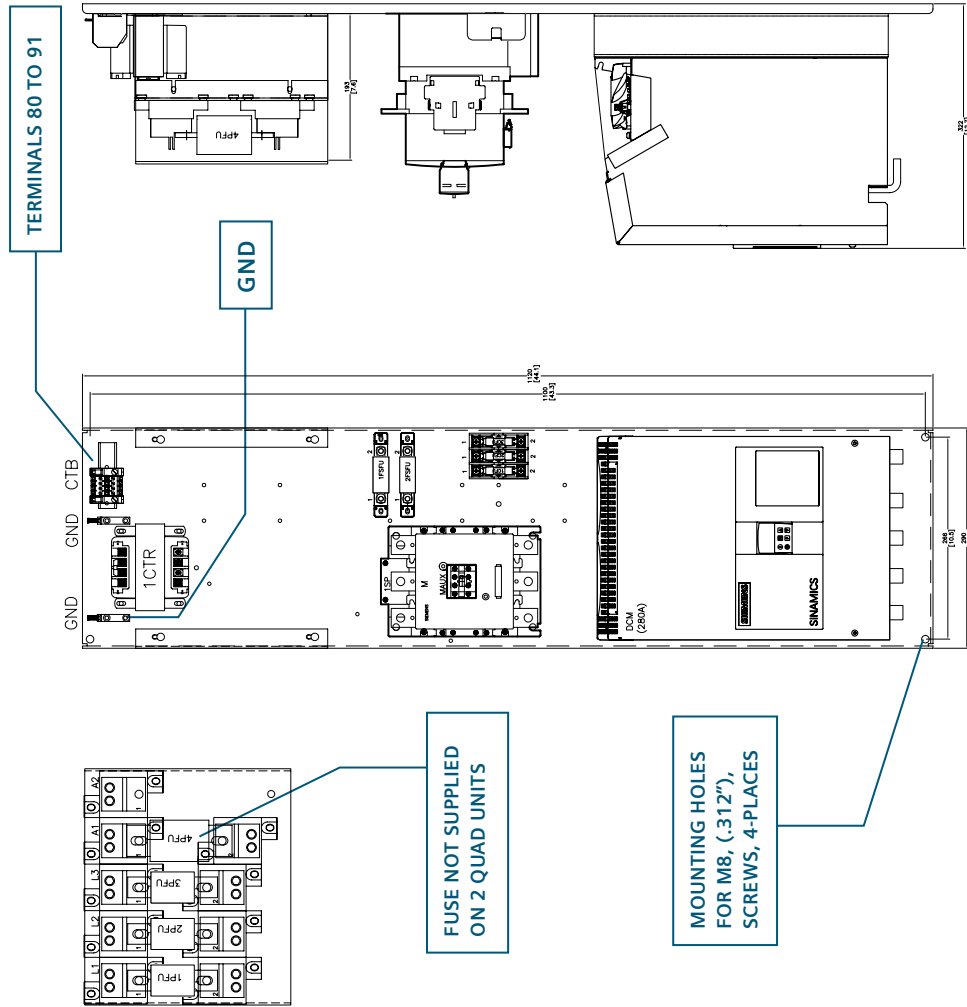

IMPORTANT NOTE: ALLOW AT LEAST 100 MILLIMETERS, (4") OF CLEARANCE ABOVE AND BELOW THE UNIT TO ENSURE UNRESTRICTED AIR FLOW, ADDITIONAL CLEARANCE MAY BE REQUIRED TO ALLOW FOR WIRE OR CABLE ENTRY/EXIT AND BENDING. REFER TO APPLICABLE CODES FOR FURTHER INFORMATION.

6 Installation and dimensions (continued)

Dimensions are mm (inches) 450 Amp panel (2 and 4Q)

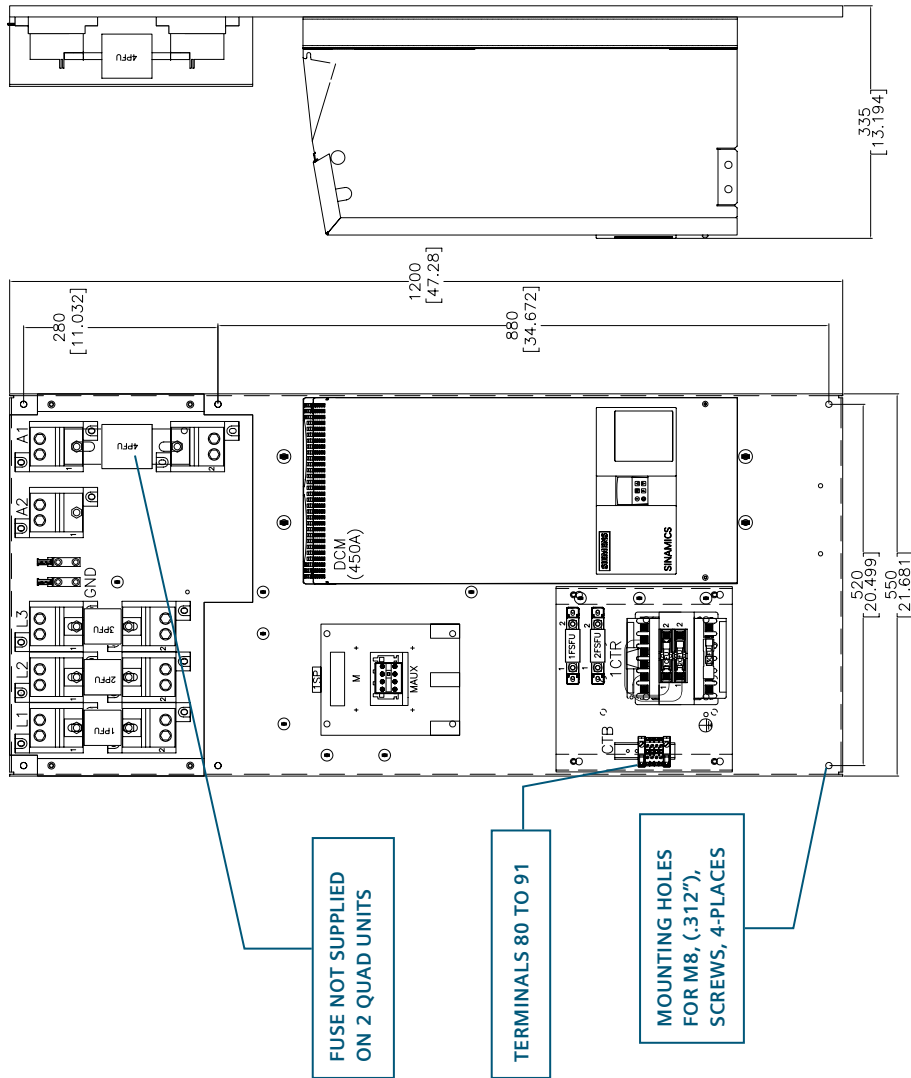

IMPORTANT NOTE: ALLOW AT LEAST 100 MILLIMETERS, (4") OF CLEARANCE ABOVE AND BELOW THE UNIT TO ENSURE UNRESTRICTED AIR FLOW, ADDITIONAL CLEARANCE MAY BE REQUIRED TO ALLOW FOR WIRE OR CABLE ENTRY/EXIT AND BENDING. REFER TO APPLICABLE CODES FOR FURTHER INFORMATION.

Dimensions are mm (inches) 600 Amp panel (2 and 4Q)

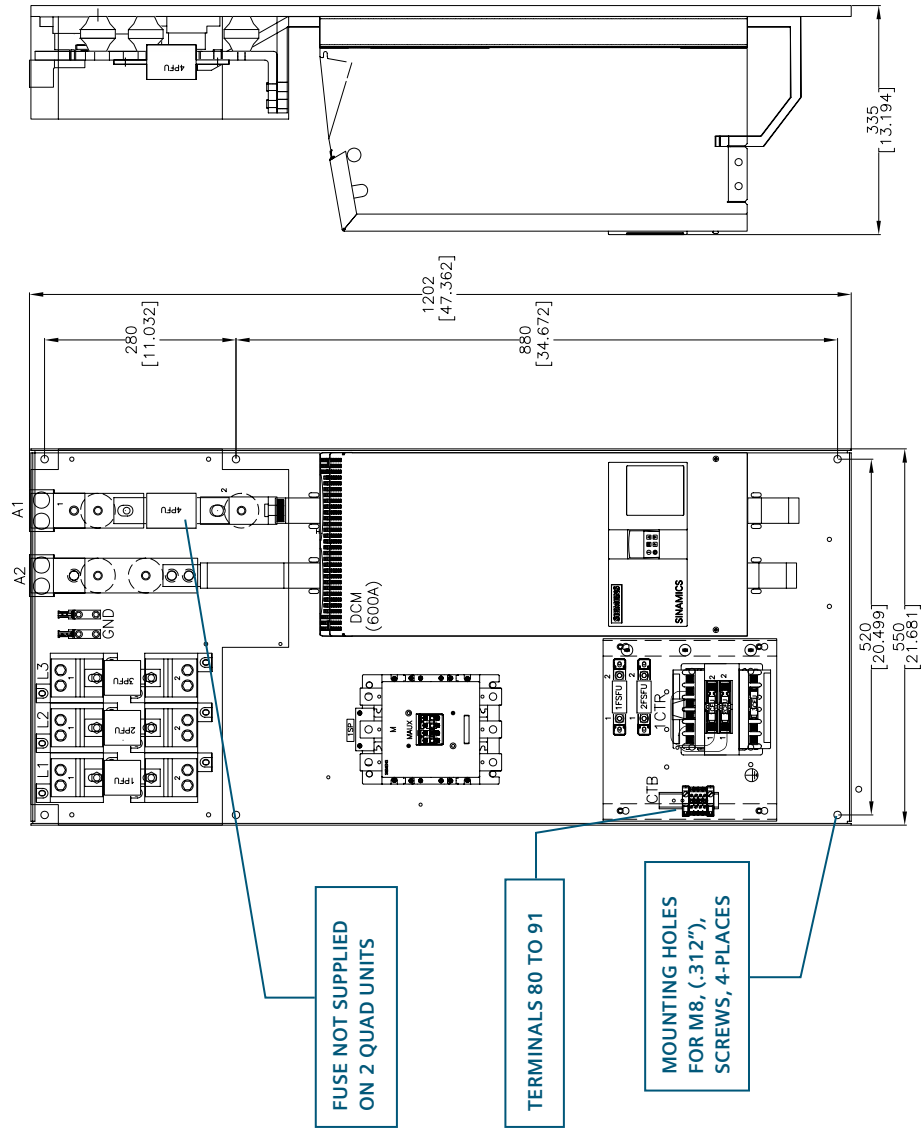

IMPORTANT NOTE: ALLOW AT LEAST 100 MILLIMETERS, (4") OF CLEARANCE ABOVE AND BELOW THE UNIT TO ENSURE UNRESTRICTED AIR FLOW, ADDITIONAL CLEARANCE MAY BE REQUIRED TO ALLOW FOR WIRE OR CABLE ENTRY/EXIT AND BENDING. REFER TO APPLICABLE CODES FOR FURTHER INFORMATION.

6 Installation and dimensions (continued)

Dimensions are mm (inches) 850 Amp panel (2 and 4Q)

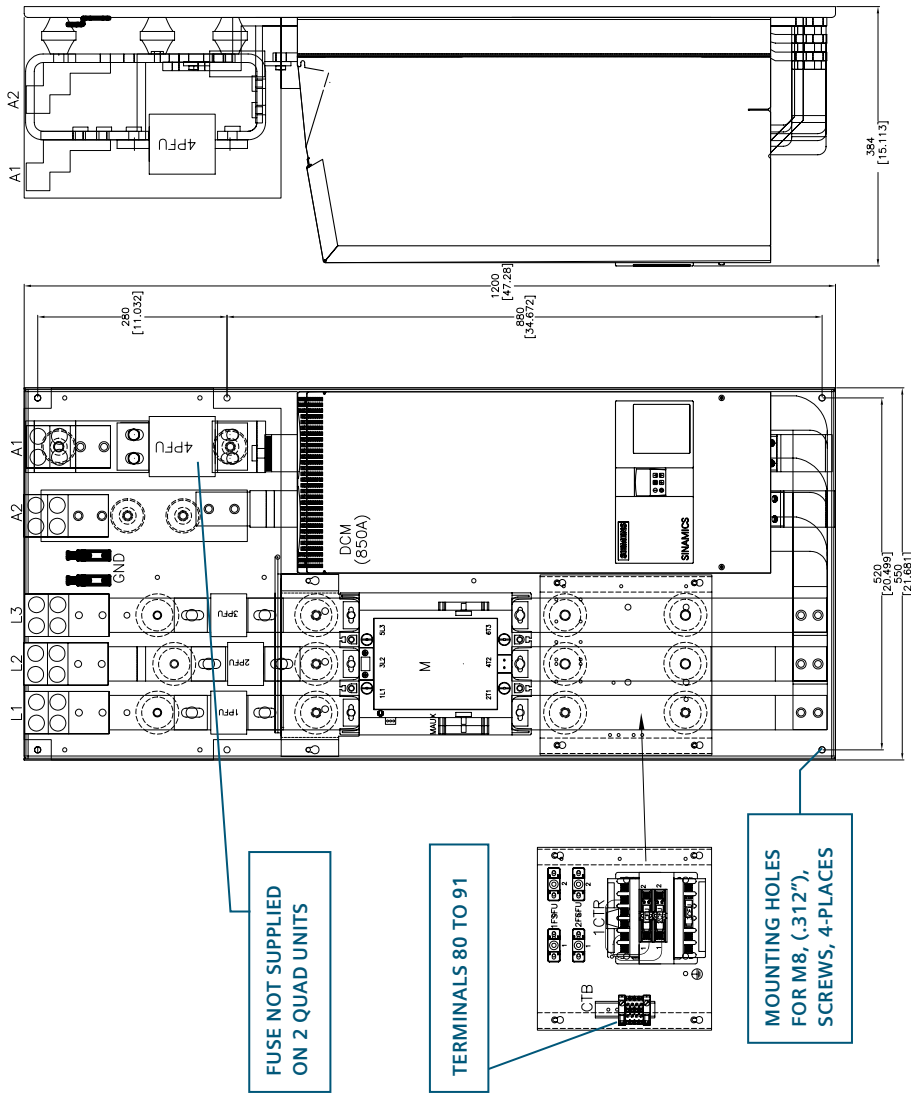

IMPORTANT NOTE: ALLOW AT LEAST 100 MILLIMETERS, (4") OF CLEARANCE ABOVE AND BELOW THE UNIT TO ENSURE UNRESTRICTED AIR FLOW, ADDITIONAL CLEARANCE MAY BE REQUIRED TO ALLOW FOR WIRE OR CABLE ENTRY/EXIT AND BENDING. REFER TO APPLICABLE CODES FOR FURTHER INFORMATION.

Dimensions are mm (inches) 1200 Amp panel (2 and 4Q)

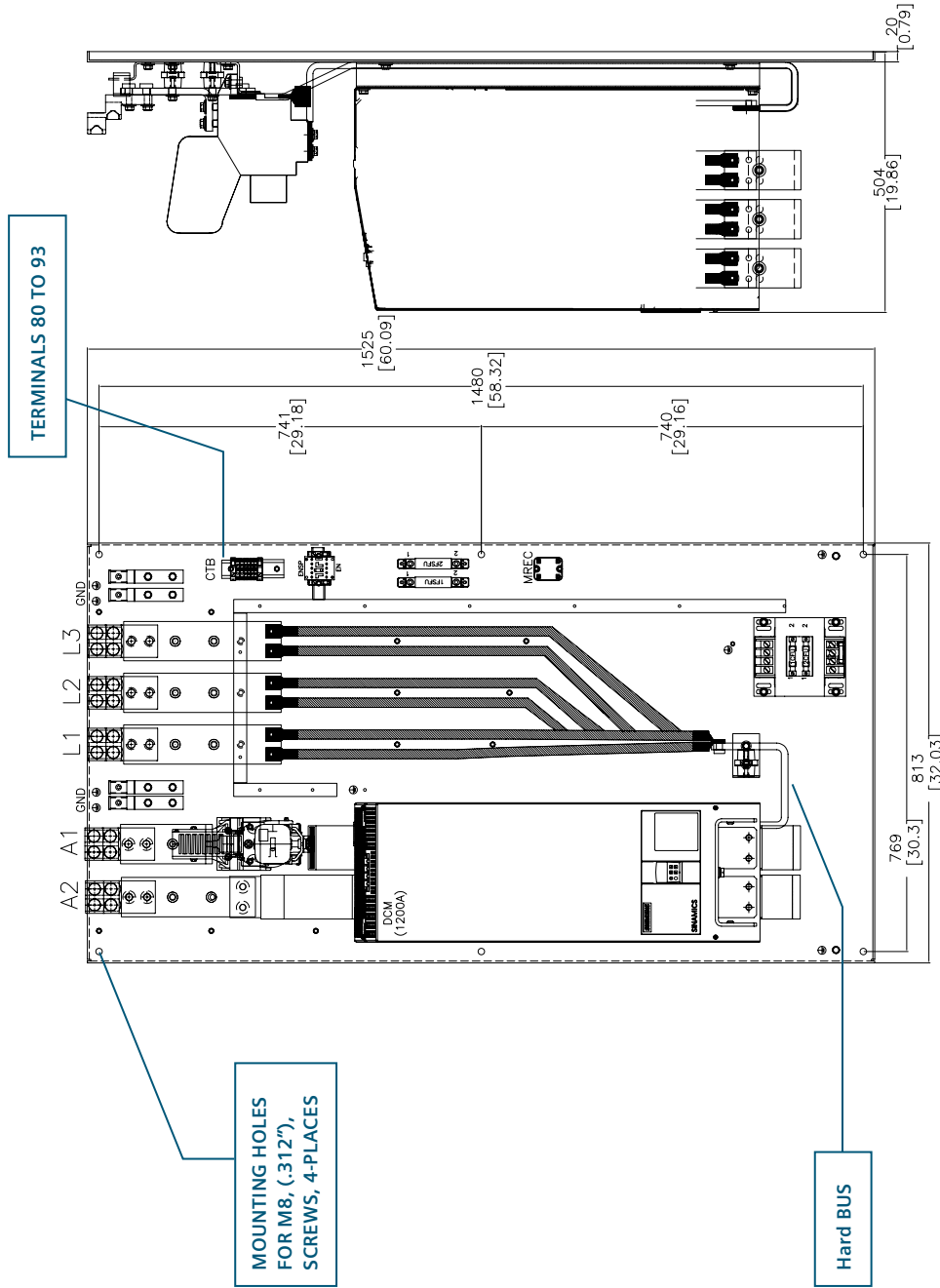

IMPORTANT NOTE: ALLOW AT LEAST 100 MILLIMETERS, (4") OF CLEARANCE ABOVE AND BELOW THE UNIT TO ENSURE UNRESTRICTED AIR FLOW, ADDITIONAL CLEARANCE MAY BE REQUIRED TO ALLOW FOR WIRE OR CABLE ENTRY/EXIT AND BENDING. REFER TO APPLICABLE CODES FOR FURTHER INFORMATION.

7 Base Drive panel connections



WARNING

SINAMICS DCM Base Drive panels are operated at high voltages.

Disconnect the power supply before making any connections!

Only qualified personnel who are thoroughly familiar with all safety notices contained in the operating instructions as well as erection, installation, operating and maintenance instructions should be allowed to work on these devices.

Non-observance of the safety instructions can result in death, severe personal injury or substantial property damage.

Failure to make the correct connections may result in irreparable damage to the unit.



Voltage may be present at the power and control terminals even when the motor is stopped.

The snubber capacitors may still carry a hazardous voltage for up to 2 minutes after disconnection. For this reason, wait for at least 2 minutes before opening the converter.

When working on the open converter, remember that live parts are exposed. The unit must always be operated with the standard front covers in place.

The user is responsible for ensuring that the motor, SINAMICS DCM Base Drive panel and other devices are installed and connected up in accordance with the approved codes of practice of the country concerned and any other regional or local codes that may apply. Special attention must be paid to proper conductor sizing, fusing, grounding, isolation and disconnection measures and to overcurrent protection.

These units contain hazardous rotating machinery (fans) and control rotating mechanical components (motors). Death, serious bodily injury or substantial property damage may occur if the instructions in the relevant manuals are not observed.

The successful and safe operation of this equipment is dependent on careful transportation, proper storage and installation as well as correct operation and maintenance.

7 Base Drive panel connections (continued)

30 Amp panel

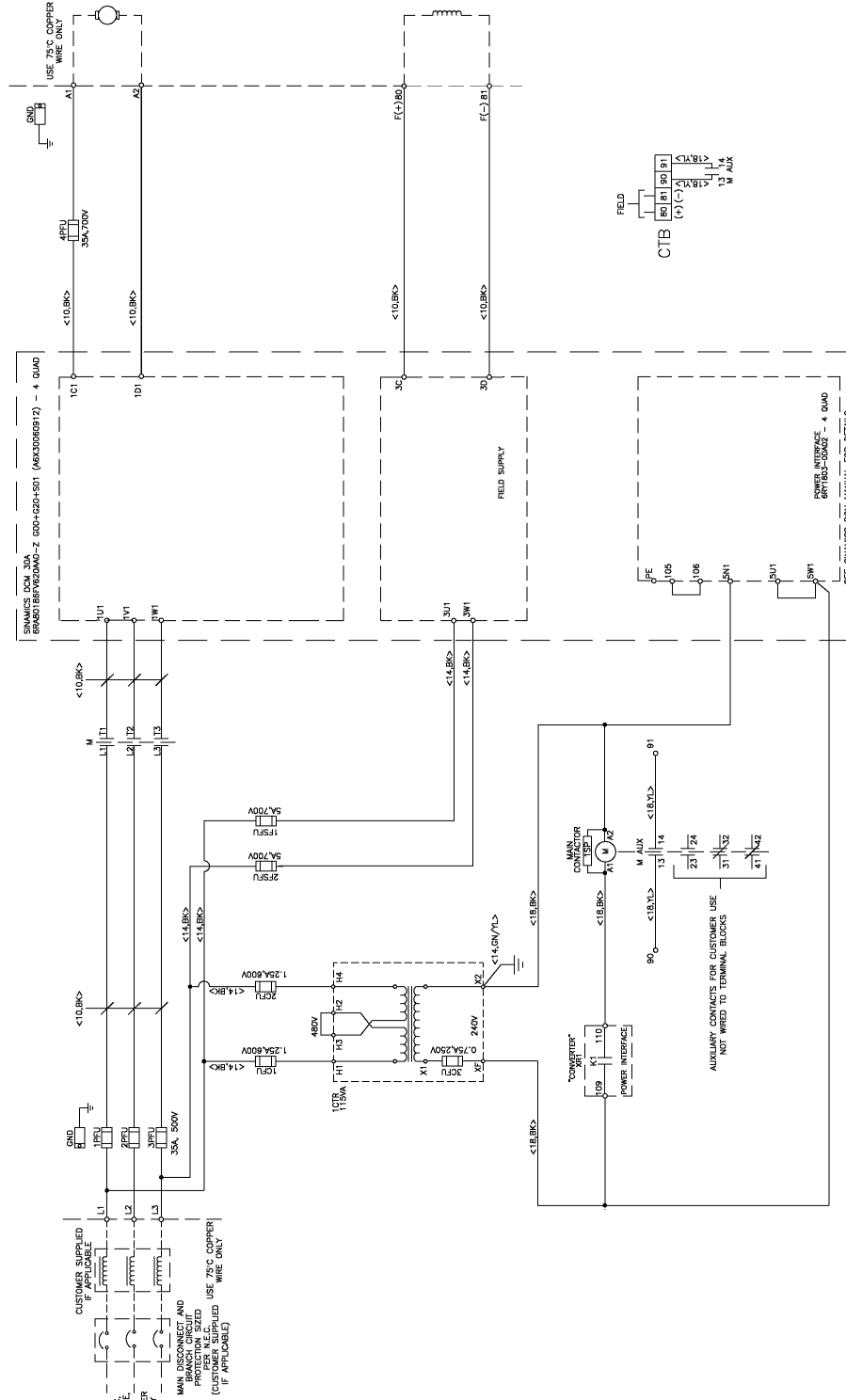

60 Amp panel

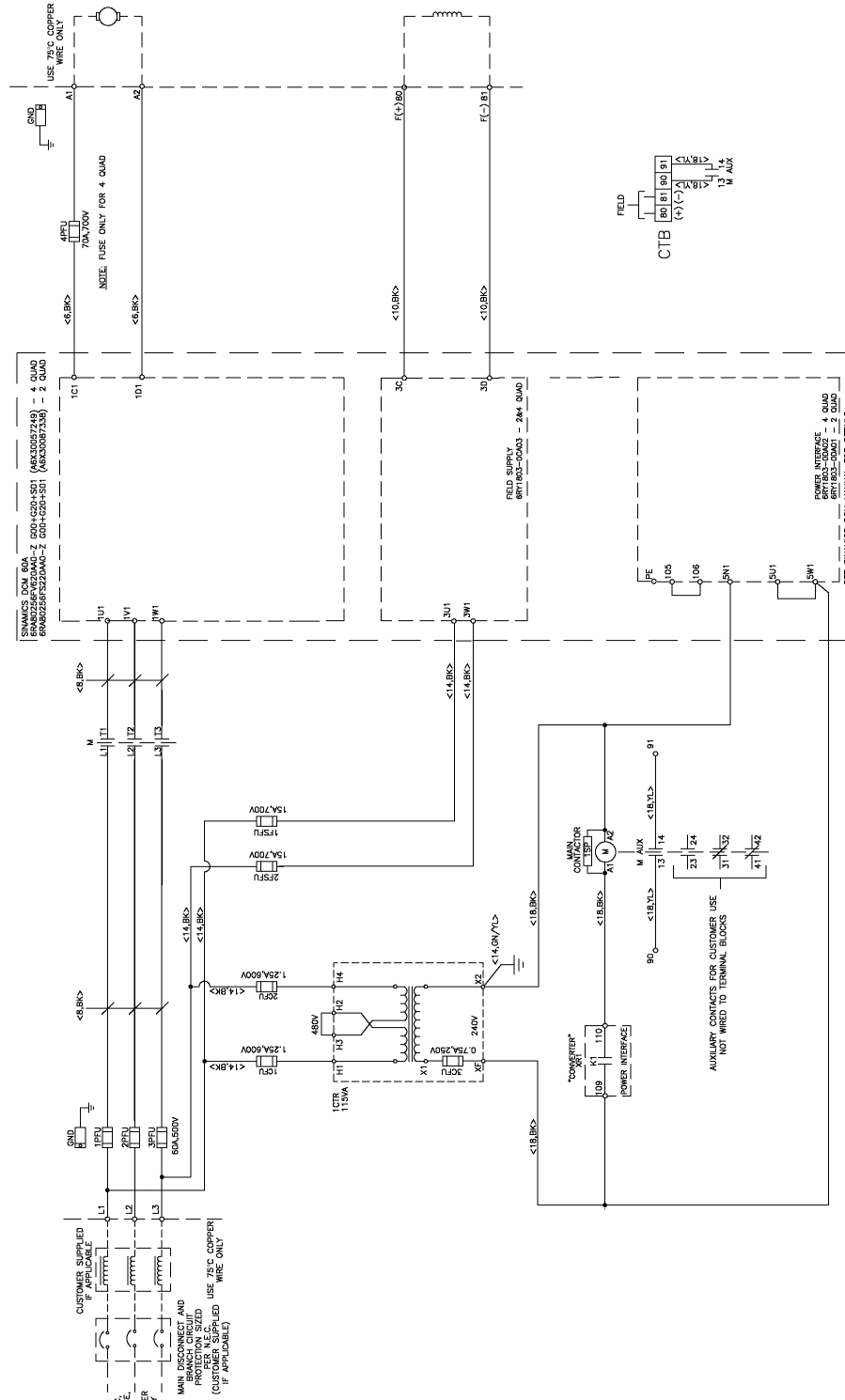

7 Base Drive panel connections (continued)

90 Amp panel

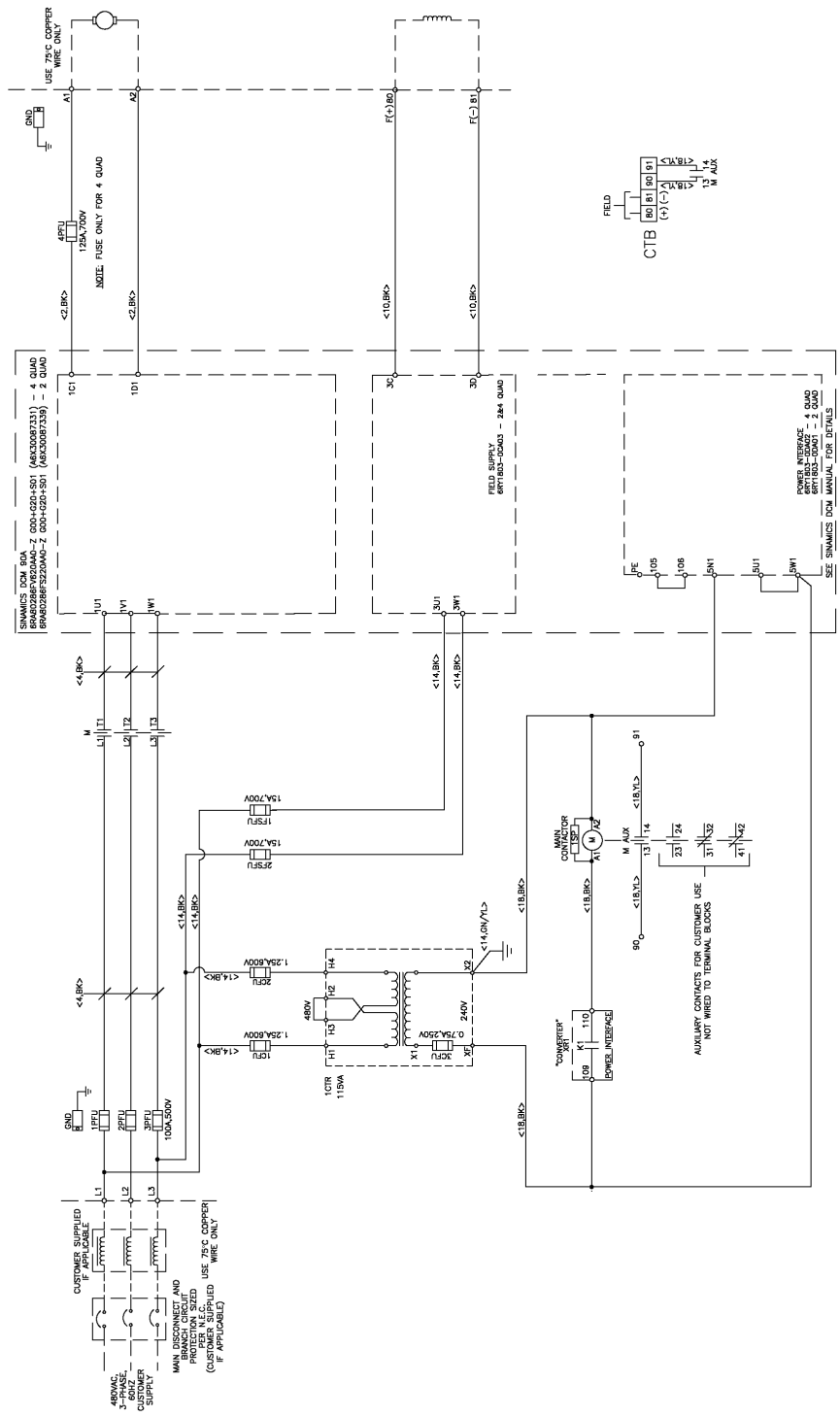

125 Amp panel

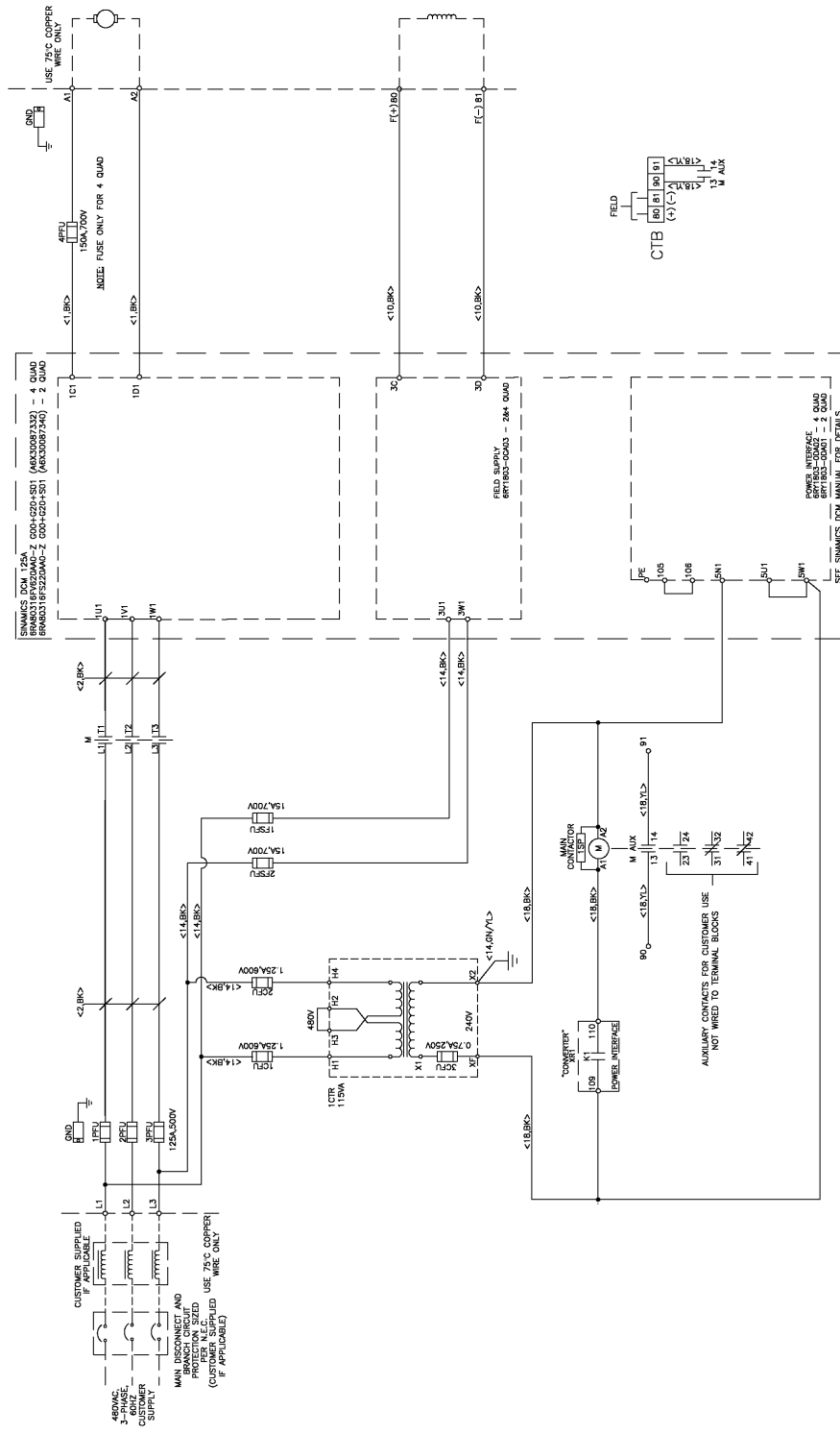

280 Amp panel

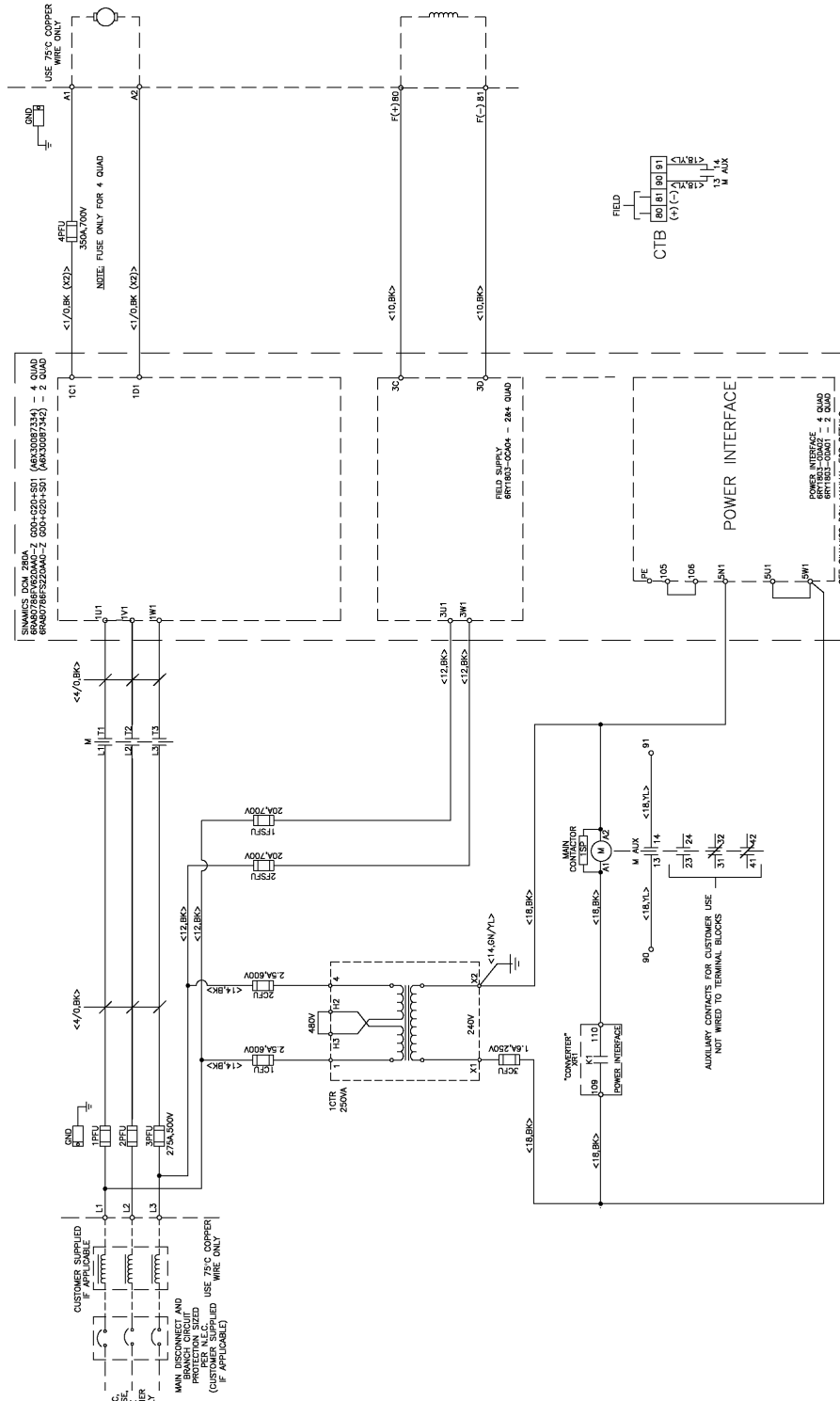

7 Base Drive panel connections (continued)

450 Amp panel

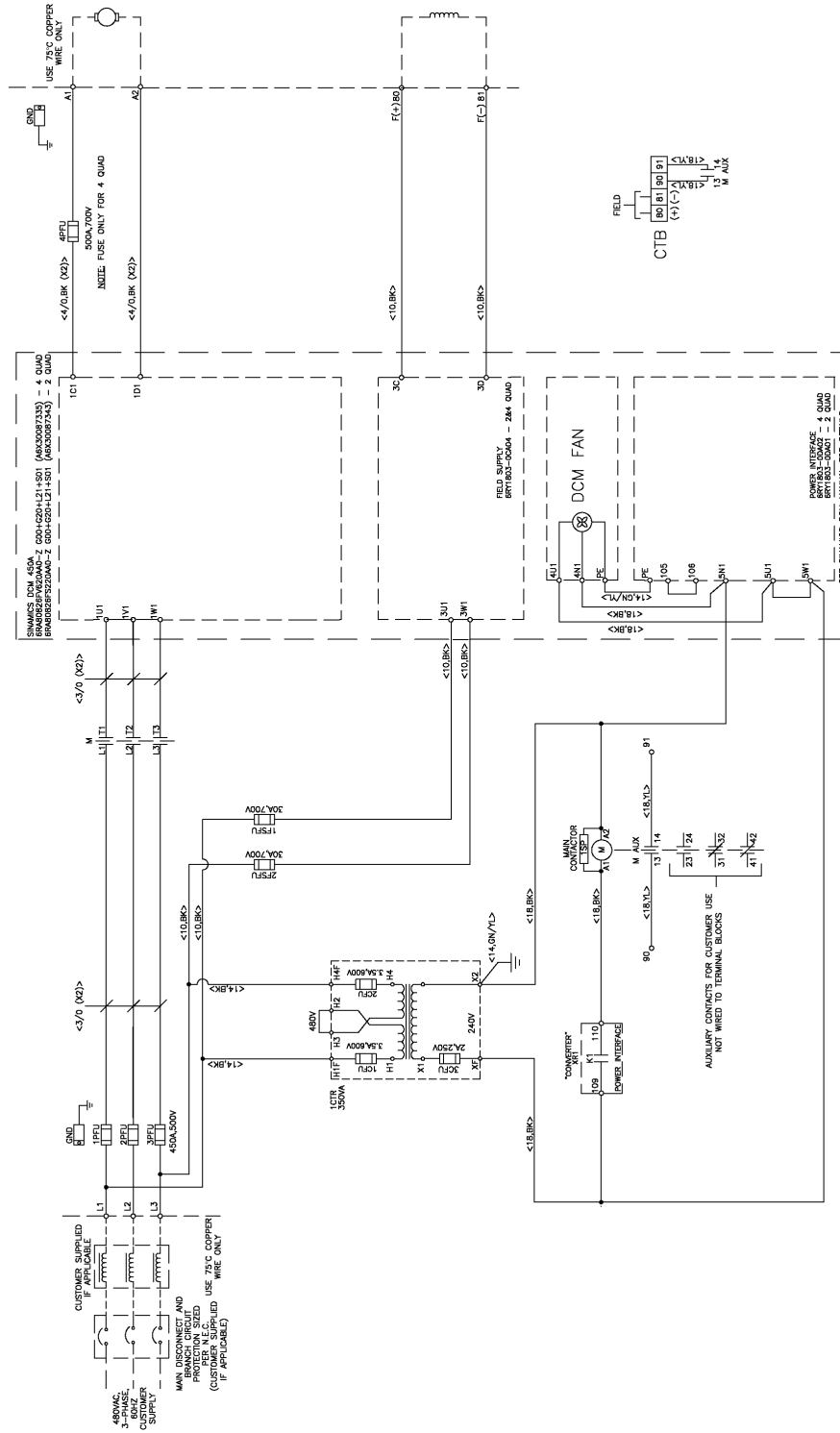

600 Amp panel

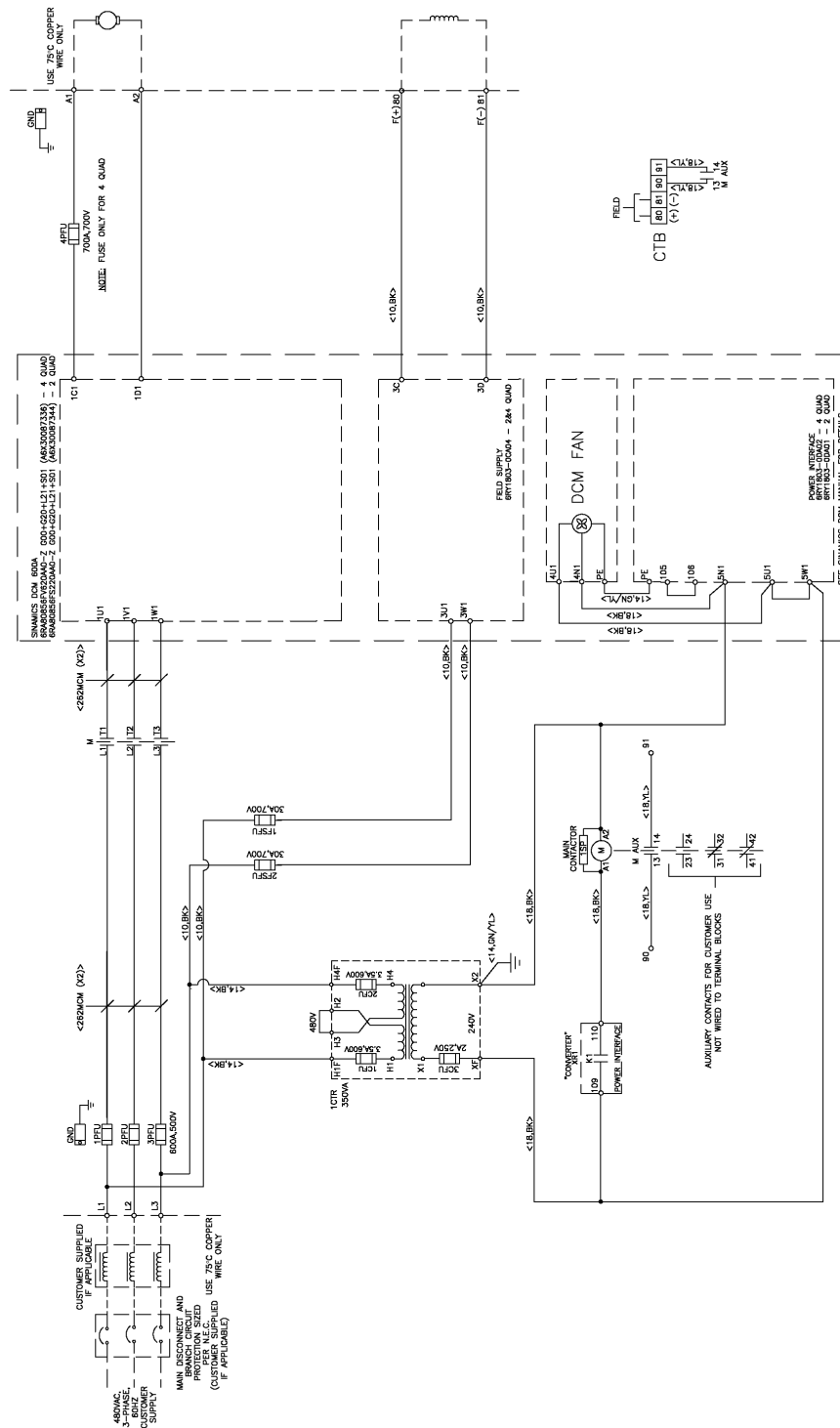

7 Base Drive panel connections (continued)

850 Amp panel

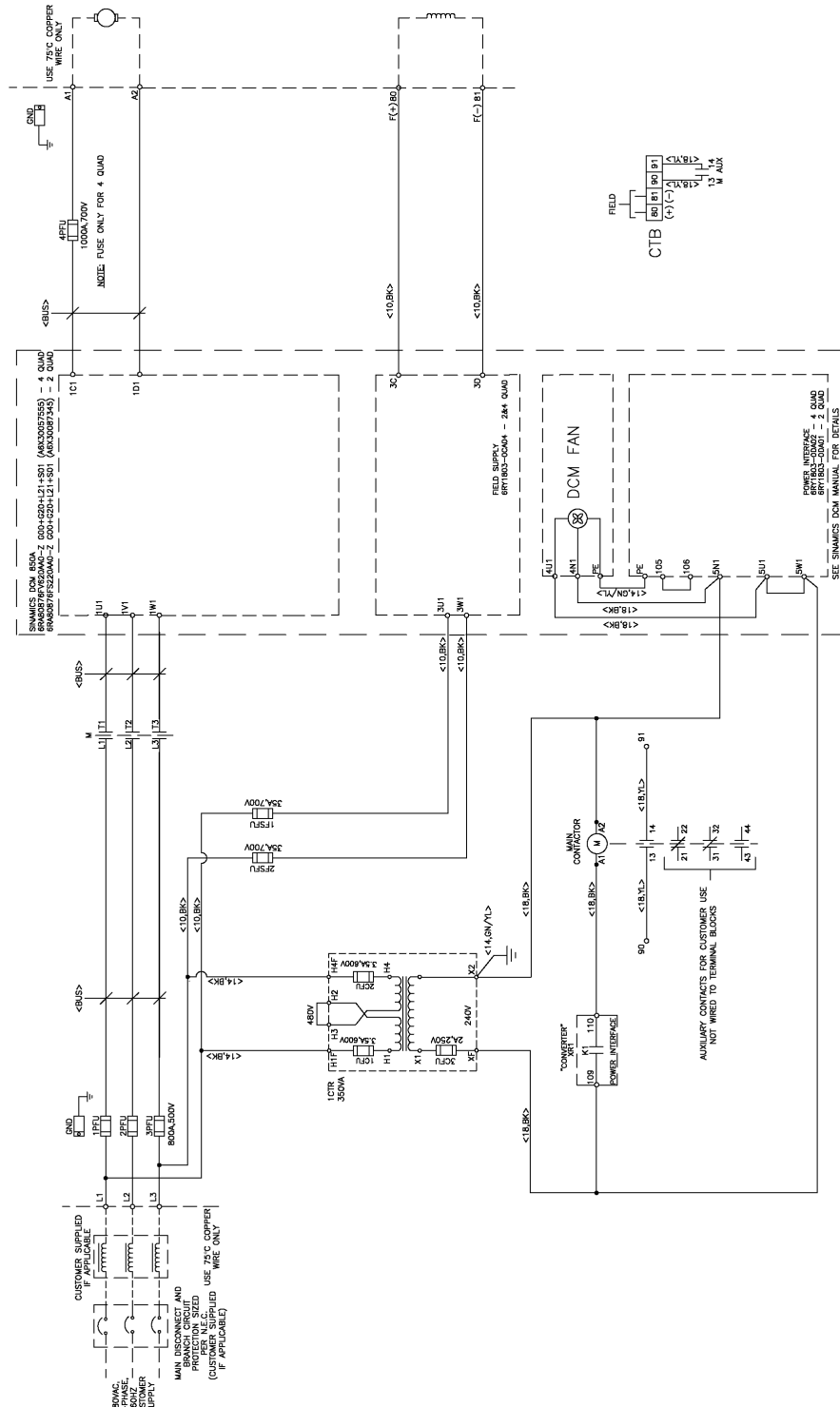

1200 Amp panel

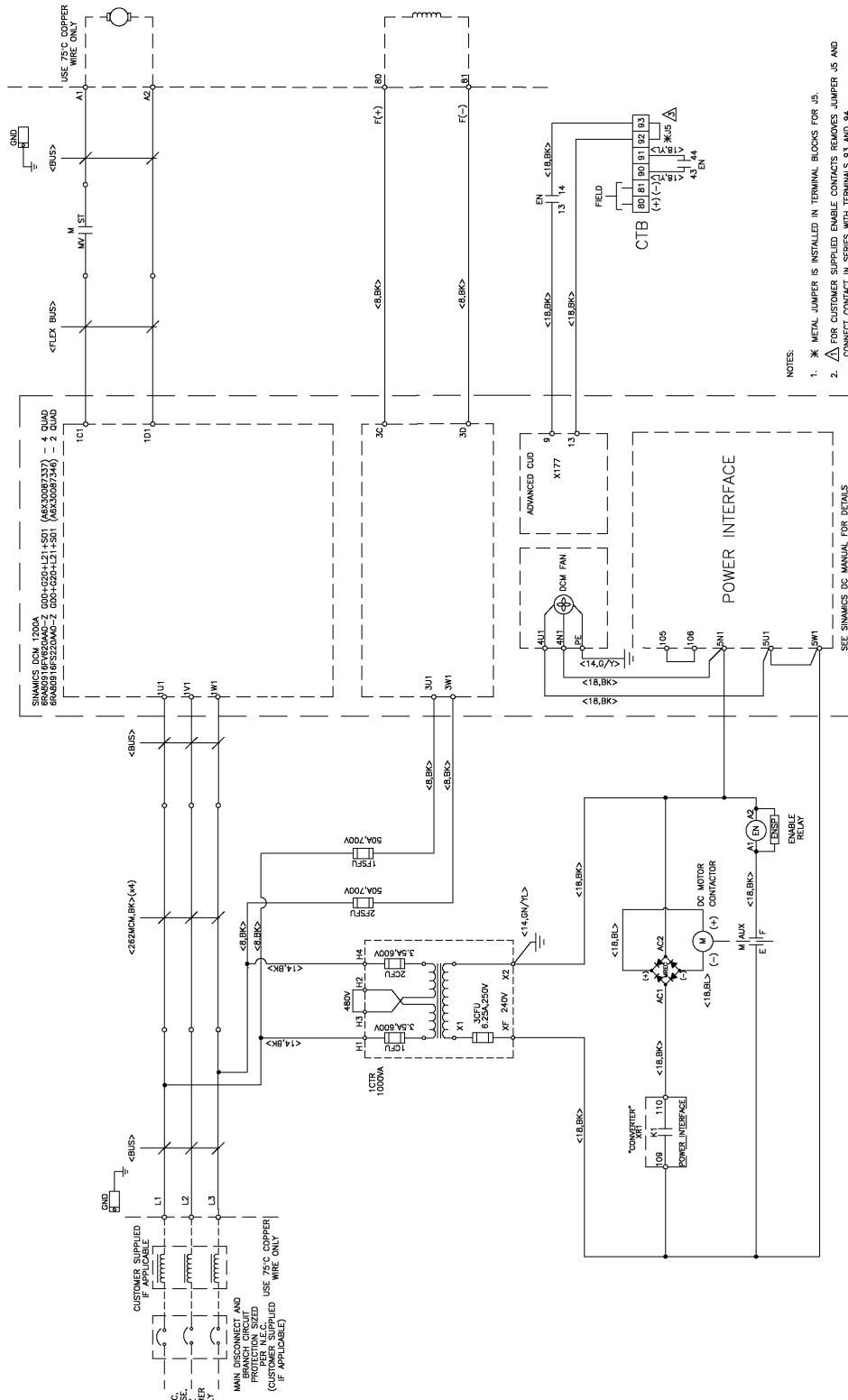

7 Base Drive panel connections (continued)

7.2 Control connections control units (CUD)

Block diagram with connection suggestion

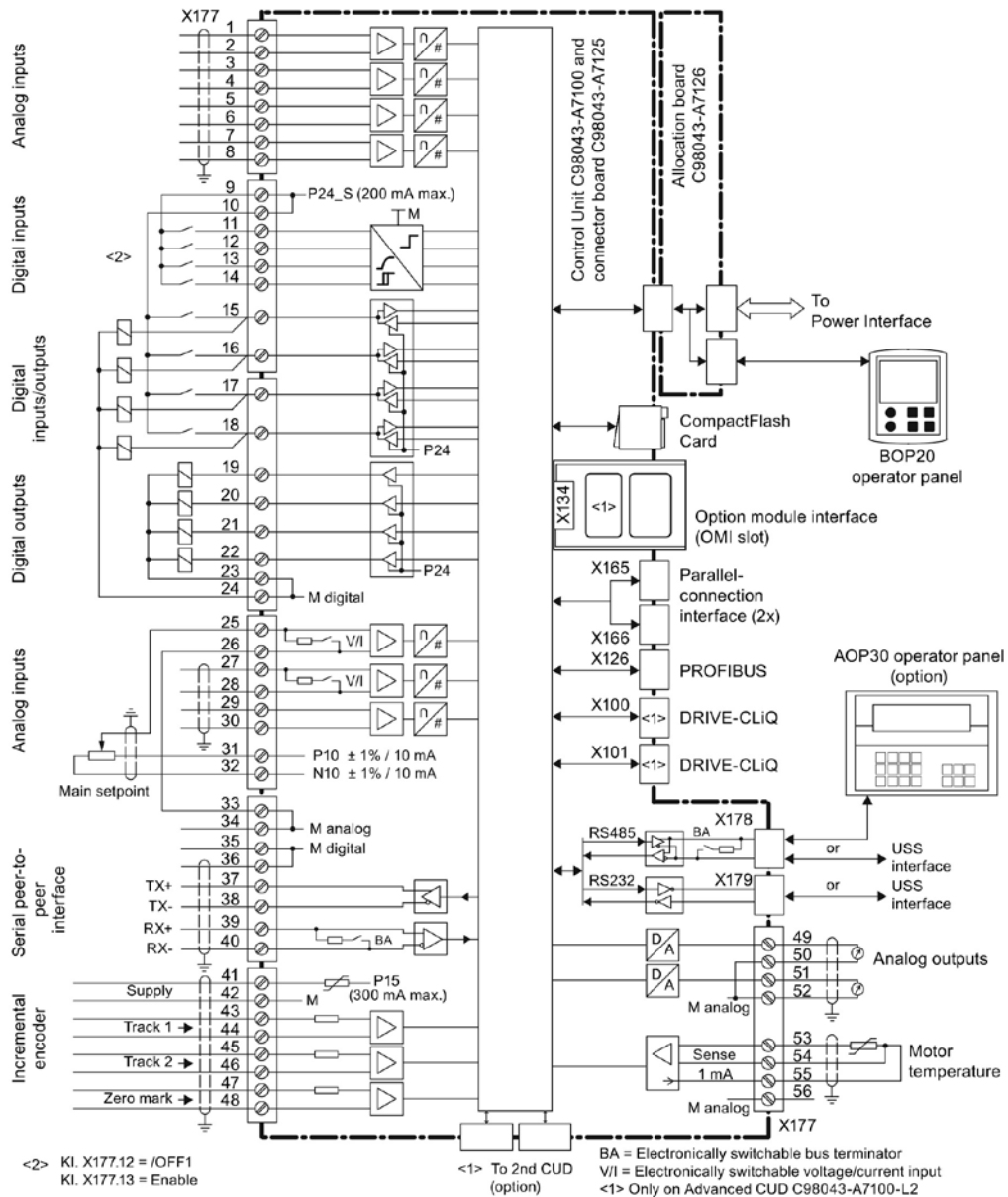

Terminal locations advanced and standard control unit DC (CUD)

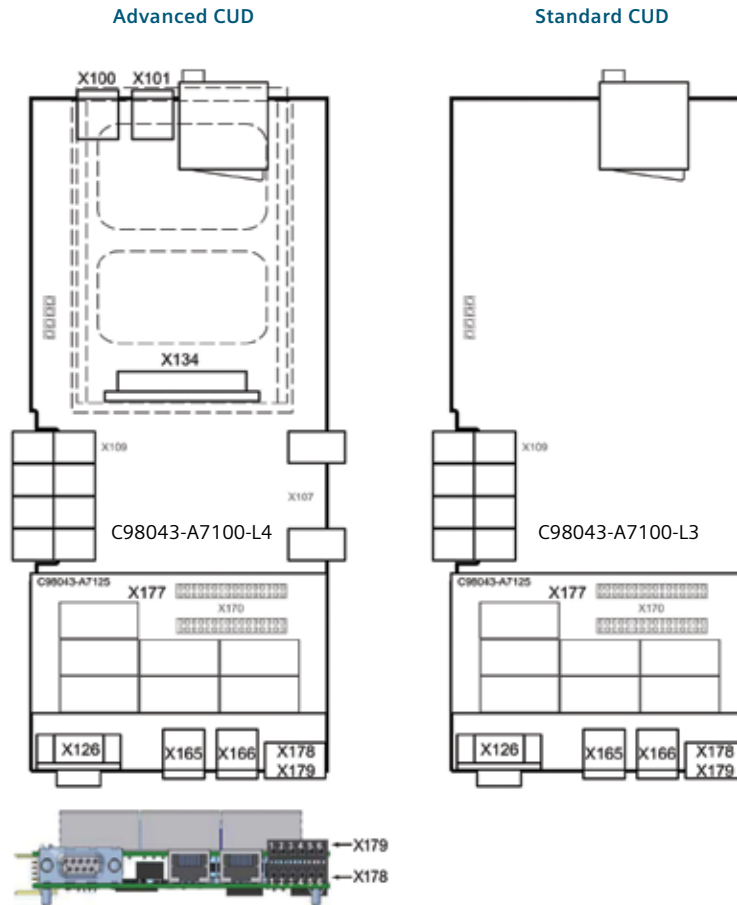
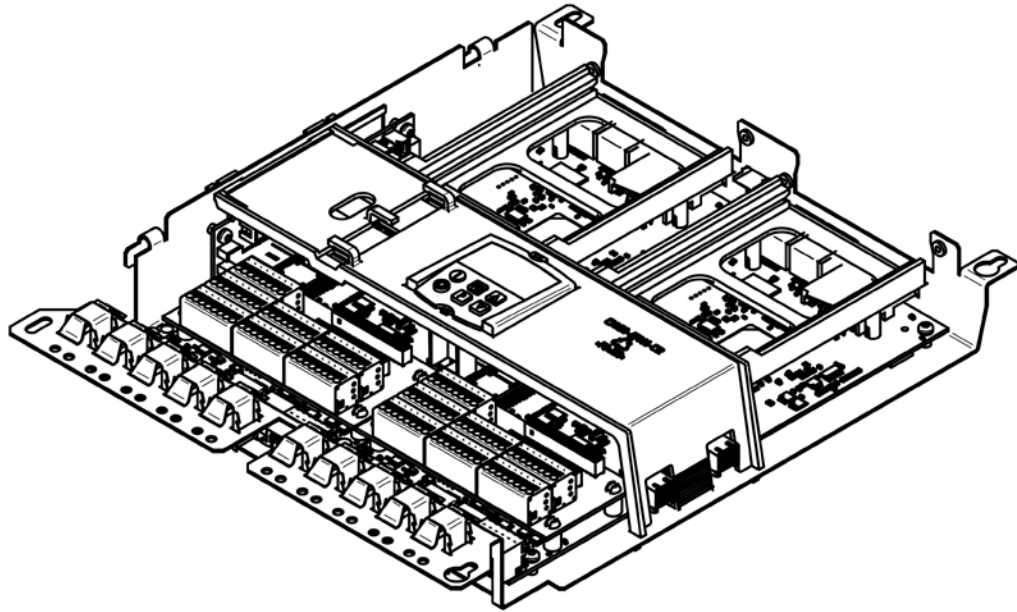

Figure 6-38 A7100 terminal/connector arrangement

Module C98043-A7100 — Control unit (CUD)
 C98043-A7100-L3 = Standard CUD
 C98043-A7100-L4 = Advanced CUD
 (shown with connector board C98043-A7125 installed)

7 Base Drive panel connections (continued)

7.3 Control units (CUD)



7.4 Description of power / control terminals



WARNING

The SINAMICS DCM Base Drive panel might sustain serious or irreparable damage if connected incorrectly.



The power cables and/or busbars must be secured mechanically outside the converter in order to provide proper stress relief at the terminals.

SINAMICS DCM Base Drive panels are complete drive assemblies that include all semiconductor type fuses, main contactor and a control transformer — ready to be connected and operated. All external connections to the SINAMICS DCM Base Drive panels, including power connections are made with compression type terminals on the drive.

The user is responsible for installation of the motor, SINAMICS DCM Base Drive panel, transformer and other devices in accordance with the National Electric Code and other applicable local codes that cover such items as wire size, protective grounding, disconnects and short circuit protection. Depending on the rating, base drives can accommodate a range of cable sizes as indicated below.

Base Drive panel power connections 15–280 Amp

Rating / termination	Cable range	Recommended torque
15, 30 Amp (4-quad only) L1, L2, L3, A1, A2----- GND-----	(1X) #14 to 2/0 AWG----- (2X) #14 to #6 AWG-----	120 IN-LBS 35 IN-LBS
60 Amp L1, L2, L3, A1, A2----- GND-----	(1X) #14 to 2/0----- (2X) #14 to #6 AWG-----	120 In LBS 35 IN-LBS
90 Amp L1, L2, L3----- A1, A2----- GND-----	(1X) #14 to 2/0----- (2X) #6 to #250 MCM----- (2X) #8 to #2 AWG-----	120 In LBS 275 IN-LBS 40 IN-LBS
125 Amp L1, L2, L3, A1, A2----- GND-----	(2X) #6 to #250 MCM----- (2X) #8 to #2 AWG-----	275 In LBS 40 IN-LBS
210, 280 Amp L1, L2, L3, A1, A2----- GND-----	(2X) #6 to #250 MCM----- (2X) #8 to #2 AWG-----	275 In LBS 40 IN-LBS

7 Base Drive panel connections (continued)

Base Drive panel power connections 450–1200 Amp

Rating / termination	Cable range	Recommended torque
450 Amp		
L1, L2, L3, A1, A2-----	(2X) #6 to 500 MCM-----	375 In LBS
GND-----	(2X) #2 to #4/0 AWG-----	150 IN-LBS
600 Amp		
L1, L2, L3-----	(2X) #6 to 500 MCM-----	375 In LBS
A1, A2-----	(2X) #2 to 600 MCM-----	500 In LBS
GND-----	(2X) #2 to #4/0 AWG-----	150 IN-LBS
850, 1200 Amp		
L1, L2, L3, A1, A2-----	(4X) #2 to 600 MCM-----	500 In LBS
GND-----	(2X) #2 to #4/0 AWG-----	150 IN-LBS

Base Drive panel control connections, (CTB), 15–1200 Amp

Rating	Wire range	Recommended torque
15–850 Amp		
CTB-80 to CTB-81-----	(1x) #14 to #8 AWG-----	7 IN-LBS
CTB-90 to CTB-91-----	(1x) #18 to #10 AWG-----	5 IN-LBS
1200 Amp		
CTB-80 to CTB-81-----	(1x) #12 to #4 AWG-----	11 IN-LBS
CTB-90 to CTB-93-----	(1x) #18 to #10 AWG-----	5 IN-LBS

NOTE

Field fuses are pre-wired at the factory to L1 and L3 (Wires must be removed for external feed connections). Remove wires from (L1 to 1FSU-1) and (L3 to 2FSU-1). Then re-connect rated external power to 1FSU1 and 2FSU1. See associated schematic for reference.

Motor armature circuit

Function	Terminal	Connection values/remarks	Possible settings
Armature supply AC input	L1 L2 L3	See SINAMICS DCM operating instruction manual and additional files on converter DVD for detailed parameter descriptions and settings.	
Ground PE conductor	⊕		
Armature circuit motor connection	A1 + A2 -		

Motor field circuit

Function	Terminal	Connection values/remarks	Possible settings
AC supply connection	1FSU	1	See SINAMICS DCM operating instruction manual and additional files on converter DVD for detailed parameter descriptions and settings
	2FSU	1	
Motor field connection	CTB	80	See SINAMICS DCM operating instruction manual and additional files on converter DVD for detailed parameter descriptions and settings
	CTB	81	

For guidance on commissioning the SINAMICS DCM Base Drive, please refer to both the SINAMICS DCM Operating Instructions and the SINAMICS DCM List Manual, which are provided on the Documentation DVD that is shipped with each Base Drive.

Siemens Industry, Inc.
100 Technology Drive
Alpharetta, GA 30005

1-770-740-3000
dc-drives.industry@siemens.com

Order No. DCMA-DCMBD-0215

Printed in USA
© 2013 Siemens Industry, Inc.

The reproduction, transmission or use of this document or contents is not permitted without express written authority. All rights, including rights created by patent grant or registration of a utility model or design, are reserved. We have checked that the contents of this publication agree with the hardware and software described herein. Nonetheless, differences might exist and therefore we cannot guarantee that they are completely identical. The information given in this publication is reviewed at regular intervals and any corrections that might be necessary are made in the subsequent printings. Suggestions for improvement are welcome at all times. SINAMICS® is a registered trademark of Siemens.