



*Allen-Bradley*

**SLC 500  
Thermocouple/mV  
Analog Input  
Module**

**1746-NT8**

**User Manual**

**Rockwell  
Automation**

## Important User Information

Solid state equipment has operational characteristics differing from those of electromechanical equipment. *Safety Guidelines for the Application, Installation and Maintenance of Solid State Controls* (Publication SGI-1.1 available from your local Rockwell Automation sales office or online at <http://www.ab.com/manuals/gi>) describes some important differences between solid state equipment and hard-wired electromechanical devices. Because of this difference, and also because of the wide variety of uses for solid state equipment, all persons responsible for applying this equipment must satisfy themselves that each intended application of this equipment is acceptable.

In no event will Rockwell Automation, Inc. be responsible or liable for indirect or consequential damages resulting from the use or application of this equipment.

The examples and diagrams in this manual are included solely for illustrative purposes. Because of the many variables and requirements associated with any particular installation, Rockwell Automation, Inc. cannot assume responsibility or liability for actual use based on the examples and diagrams.

No patent liability is assumed by Rockwell Automation, Inc. with respect to use of information, circuits, equipment, or software described in this manual.

Reproduction of the contents of this manual, in whole or in part, without written permission of Rockwell Automation, Inc. is prohibited.

Throughout this manual, when necessary we use notes to make you aware of safety considerations.

---

**WARNING**

Identifies information about practices or circumstances that can cause an explosion in a hazardous environment, which may lead to personal injury or death, property damage, or economic loss.

---

**IMPORTANT**

Identifies information that is critical for successful application and understanding of the product.

---

**ATTENTION**

Identifies information about practices or circumstances that can lead to personal injury or death, property damage, or economic loss. Attentions help you:

- identify a hazard
- avoid a hazard
- recognize the consequence

---

**SHOCK HAZARD**

Labels may be located on or inside the equipment (e.g., drive or motor) to alert people that dangerous voltage may be present.

---

**BURN HAZARD**

Labels may be located on or inside the equipment (e.g., drive or motor) to alert people that surfaces may be dangerous temperatures.

---

<b>Preface</b>	Who Should Use This Manual . . . . .	P-1
	What This Manual Covers . . . . .	P-1
	Related Documentation . . . . .	P-2
	Common Techniques Used in this Manual . . . . .	P-2
	 <b>Chapter 1</b>	
<b>Module Overview</b>	General Description . . . . .	1-1
	Input Ranges . . . . .	1-1
	Hardware Features . . . . .	1-2
	Diagnostic LEDs . . . . .	1-3
	System Overview . . . . .	1-3
	System Operation . . . . .	1-4
	Module Operation . . . . .	1-5
	Module Addressing . . . . .	1-5
	Block Diagram . . . . .	1-6
	Linear Millivolt Device Compatibility . . . . .	1-7
	 <b>Chapter 2</b>	
<b>Installing And Wiring Your Module</b>	Electrostatic Damage . . . . .	2-1
	Power Requirements . . . . .	2-2
	Considerations for a Modular System . . . . .	2-2
	Fixed I/O Chassis - I/O Module Compatibility . . . . .	2-3
	General Considerations . . . . .	2-4
	Module Installation and Removal . . . . .	2-5
	Terminal Block Removal . . . . .	2-6
	Wiring Your Module . . . . .	2-7
	Preparing and Wiring the Cables . . . . .	2-9
	Cold-Junction Compensation (CJC) . . . . .	2-11
	 <b>Chapter 3</b>	
<b>Considerations Before Using Your Module</b>	Module ID Code . . . . .	3-1
	Module Addressing . . . . .	3-2
	Output Image - Configuration Words . . . . .	3-2
	Input Image - Data Words and Status Words . . . . .	3-3
	Channel Filter Frequency Selection . . . . .	3-3
	Channel Cut-Off Frequency . . . . .	3-4
	Channel Step Response . . . . .	3-6
	Update Time . . . . .	3-7
	Update Time Calculation Example . . . . .	3-8
	Channel Turn-On, Turn-Off, and Reconfiguration Times . . . . .	3-8
	Auto-calibration . . . . .	3-8
	Response to Slot Disabling . . . . .	3-9
	Input Response . . . . .	3-9
	Output Response . . . . .	3-9

	<b>Chapter 4</b>	
<b>Channel Configuration, Data, and Status</b>	Channel Configuration . . . . .	4-1
	Channel Configuration Procedure . . . . .	4-2
	Select Channel Enable (Bit 0) . . . . .	4-5
	Select Input Types (Bits 1 through 4) . . . . .	4-5
	Select Data Format (Bits 5 and 6) . . . . .	4-5
	Using Scaled-for-PID and Proportional Counts . . . . .	4-6
	Effective Resolutions . . . . .	4-6
	Scaling Examples . . . . .	4-7
	Select Open-Circuit State (Bits 7 and 8) . . . . .	4-9
	Select Temperature Units (Bit 9) . . . . .	4-10
	Select Channel Filter Frequency (Bits 10 and 11) . . . . .	4-10
	Unused Bits (Bits 12 through 14) . . . . .	4-11
	Select Input Image Type (Bit 15) . . . . .	4-11
	Channel Data/Status Word . . . . .	4-11
	Channel Status Checking . . . . .	4-12
	Channel Status (Bit 0) . . . . .	4-14
	Input Type Status (Bits 1 through 4) . . . . .	4-14
	Data Format Type Status (Bits 5 and 6) . . . . .	4-14
	Open-Circuit Type Status (Bits 7 and 8) . . . . .	4-14
	Temperature Units Type Status (Bit 9) . . . . .	4-14
	Channel Filter Frequency (Bits 10 and 11) . . . . .	4-15
	Open-Circuit E. . . . .	4-15
	Under-Range Error (Bit 13) . . . . .	4-15
	Over-Range Error (Bit 14) . . . . .	4-15
	Channel Error (Bit 15) . . . . .	4-15
	<b>Chapter 5</b>	
<b>Programming Examples</b>	Procedure . . . . .	5-2
	Automatic Monitoring Thermocouples and CJC Sensors . . . . .	5-3
	Verifying Configuration Changes . . . . .	5-3
	Interfacing to the PID Instruction . . . . .	5-7
	Monitoring Channel Status Bits . . . . .	5-8
	Monitoring Channel Status Bits Example . . . . .	5-9
	PLC 5 Example with NT8 in Remote I/O Rack . . . . .	5-13
SLC 500 Example with NT8 in Remote I/O Rack . . . . .	5-15	
	<b>Chapter 6</b>	
<b>Troubleshooting Your Module</b>	Module and Channel Diagnostics . . . . .	6-1
	Module Diagnostics at Powerup . . . . .	6-1
	Channel Diagnostics . . . . .	6-1
	LED Troubleshooting Tables . . . . .	6-3
	Channel-status LEDs (Green) . . . . .	6-4
	Open-circuit Detection (Bit 12) . . . . .	6-4

	Out-of-Range Detection (Bit 13 for Under Range, Bit 14 for Over Range) . . . . .	6-4
	Channel Error (Bit 15) . . . . .	6-5
	Module Status LED (Green) . . . . .	6-5
	Interpreting I/O Error Codes . . . . .	6-5
	<b>Chapter 7</b>	
<b>Maintaining Your Module And Safety Considerations</b>	Preventive Maintenance. . . . .	7-1
	Safety Considerations . . . . .	7-1
	<b>Appendix A</b>	
<b>Module Specifications</b>	Electrical Specifications . . . . .	A-1
	Physical Specifications. . . . .	A-2
	Environmental Specifications . . . . .	A-2
	Input Specifications. . . . .	A-3
	Overall Accuracy . . . . .	A-4
	Millivolt. . . . .	A-4
	Thermocouple. . . . .	A-6
	<b>Appendix B</b>	
<b>Using Grounded Junction, Ungrounded Junction, and Exposed Junction Thermocouples</b>	Thermocouple Types . . . . .	B-1
	Grounded Junction . . . . .	B-2
	Ungrounded (Insulated) Junction . . . . .	B-2
	Exposed Junction. . . . .	B-2
	Isolation . . . . .	B-2
	Grounded Junction . . . . .	B-3
	Exposed Junction Thermocouples. . . . .	B-4
	<b>Appendix C</b>	
<b>Configuring the 1746-NT8 Module with RSLogix 500</b>		
	<b>Glossary</b>	
	<b>Index</b>	



## Summary of Changes

---

The information below summarizes the changes to this manual since the last printing. Updates to the manual include using RSLogix 500 instead of APS software.

To help you find new and updated information in this release of the manual, we have included change bars as shown to the right of this paragraph.

The table below lists the sections that document new features and additional or updated information on existing features.

<b>For this information:</b>	<b>See</b>
updated data table for initial programming	page 5-2
added SLC 500 example with NT8 in Remote I/O Rack	page 5-15
updated thermocouple graphs	page A-8
configuring NT8 with RSLogix 500	page C-1





Read this preface to familiarize yourself with this user manual. This preface covers:

- who should use this manual
- what this manual provides
- related documents
- common techniques used in this manual

### **Who Should Use This Manual**

Use this manual if you design, install, program, or maintain a control system that uses SLC 500™ controllers.

You should have a basic understanding of SLC 500 products. You should also understand electronic process control and the ladder program instructions required to generate the electronic signals that control your application. If you do not, contact your local Rockwell Automation representative for the proper training before using these products.

### **What This Manual Covers**

This manual covers the 1746-NT8 thermocouple/millivolt analog input module. It contains the information you need to install, wire, use, and maintain these modules. It also provides diagnostic and troubleshooting help should the need arise.

## Related Documentation

The following table lists several Rockwell Automation documents that may help you as you use these products.

Publication Number	Title
1746-SG001	SLC 500™ Systems Selection Guide
SGL-1.1	Safety Guidelines for the Application, Installation and Maintenance of Solid State Controllers
1770-4.1	Industrial Automation Wiring and Grounding Guidelines
1747-UM011	SLC 500 Modular Hardware Style User Manual
1747-6.21	Installation & Operation Manual for Fixed Hardware Style Programmable Controllers
1747-RM001	SLC 500 Instruction Set Reference Manual
AG-7.1	Allen-Bradley Industrial Automation Glossary

If you would like to:

- view and download the publication, go to Literature Library at <http://www.rockwellautomation.com/literature>
- order printed copies, contact your Allen-Bradley Distributor or Rockwell Automation Sales Office.

## Common Techniques Used in this Manual

The following conventions are used throughout this manual:

- Bulleted lists such as this one provide information, not procedural steps.
- Numbered lists provide sequential steps or hierarchical information.
- Text in **this font** indicates words or phrases you should type.
- Key names appear in bold, capital letters within brackets (for example, **[ENTER]**).

## Module Overview

This chapter describes the thermocouple/mV input module and explains how the SLC 500 processor reads thermocouple or millivolt analog input data from the module.

Read this chapter to familiarize yourself further with your thermocouple/mV analog input module. This chapter covers:

- general description and hardware features
- an overview of system and module operation
- block diagram of channel input circuits

## General Description

This module mounts into 1746 I/O chassis for use with SLC 500 fixed and modular systems. The module stores digitally converted thermocouple/mV analog data in its image table for retrieval by all fixed and modular SLC 500 processors. The module supports connections from any combination of up to eight thermocouple/mV analog sensors.

## Input Ranges

The following tables define thermocouple types and associated temperature ranges and the millivolt analog input signal ranges that each of the module's input channels support. To determine the practical temperature range of your thermocouple, refer to the specifications in Appendix A.

### Thermocouple Temperature Ranges

Type	°C Temperature Range	°F Temperature Range
J	-210°C to +760°C	-346°F to +1400°F
K	-270°C to +1370°C	-454°F to +2498°F
T	-270°C to +400°C	-454°F to +752°F
B	+300°C to +1820°C	+572°C to +3308°F
E	-270°C to +1000°C	-454°F to +1832°F
R	0°C to +1768°C	+32 F to +3214°F

Type	°C Temperature Range	°F Temperature Range
S	0°C to +1768°C	+32°F to +3214°F
N	0°C to +1300°C	+32°F to +2372°F
CJC Sensor	-25°C to +105°C	-13°F to +221 °F

### Millivolt Input Ranges<sup>(1)</sup>

---

-50 to +50 mV

---

-100 to +100 mV

---

Each input channel is individually configured for a specific input device, and provides open-circuit, over-range, and under-range detection and indication.

## Hardware Features

The module fits into any single slot for I/O modules in either an SLC 500 modular system or an SLC 500 fixed system expansion chassis (1746-A2), except the zero slot which is reserved for the processor. It is a Class 1 module using 8 input words and 8 output words.<sup>(2)</sup>

The module contains a removable terminal block providing connections for eight thermocouple and/or analog input devices. On the terminal block are two cold-junction compensation (CJC) sensors that compensate for the cold junction at ambient temperature. It should also be noted there are no output channels on the module. Configure the module with software rather than with jumpers or switches.

### IMPORTANT

There is a jumper (JP1) on the circuit board. The module is shipped with the jumper in the up position as illustrated below. Do not change the position of JP1. The jumper is used for test purposes only.

(1) Output impedance of input device must be less than 100 ohm to meet accuracy specifications.

(2) Requires use of a Block Transfer when used in a remote rack with a 1747-ASB.

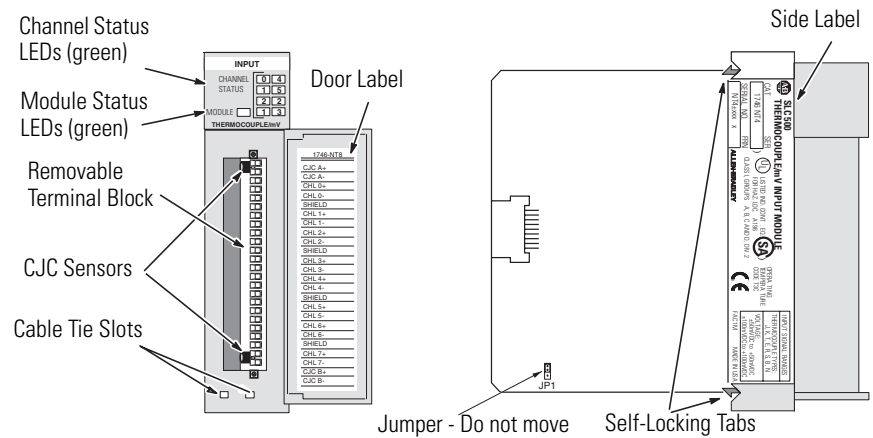

*Hardware Features*

Hardware	Function
Channel Status LED Indicators	Display operating and fault status of channels 0 to 7
Module Status LED	Displays operating and fault status of the module
Side Label (Nameplate)	Provides module information
Removable Terminal Block	Provides electrical connection to input devices
Door Label	Permits easy terminal identification
Cable Tie Slots	Secure and route wiring from module
Self Locking Tabs	Secure module in chassis slot

**Diagnostic LEDs**

The module contains diagnostic LEDs that help you identify the source of problems that may occur during power-up or during normal operation. Power-up and channel diagnostics are explained in Chapter 6, Testing Your Module.

**System Overview**

The module communicates with the SLC 500 processor and receives +5V dc and +24V dc power from the system power supply through the parallel backplane interface. No external power supply is required. You may install as many thermocouple modules in the system as the power supply can support.

Each module channel can receive input signals from a thermocouple or a mV analog input device. You configure each channel to accept either one. When configured for thermocouple input types, the module converts analog input voltages into cold-junction compensated and linearized, digital temperature readings. The module uses National Institute of Standards and Technology (NIST) ITS-90 for thermocouple linearization.

When configured for millivolt analog inputs, the module converts analog values directly into digital counts. The module assumes that the mV input signal is linear.

## System Operation

At power-up, the module checks its internal circuits, memory, and basic functions. During this time the module status LED remains off. If the module finds no faults, it turns on its module status LED.

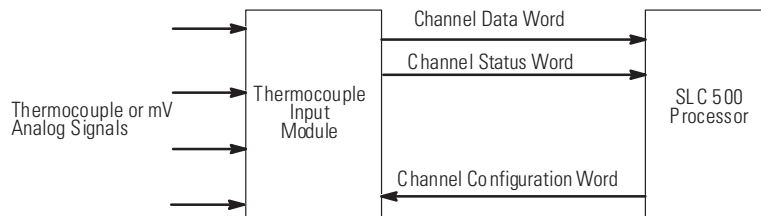

After completing power-up checks, the module waits for valid channel configuration data from your SLC ladder logic program (channel status LEDs are off). After channel configuration data is transferred and channel enable bits are set, the enabled channel status LEDs turn on. Then the channel continuously converts the thermocouple or millivolt input to a value within the range you selected for the channel.

Each time the module reads an input channel, the module tests that data for a fault, i.e. over-range or under-range condition. If open circuit detection is enabled, the module tests for an open-circuit condition. If it detects an open-circuit, over-range, or under-range condition, the module sets a unique bit in the channel status word and causes the channel status LED to flash.

The SLC processor reads the converted thermocouple or millivolt data from the module at the end of the program scan, or when commanded by the ladder program. After the processor and module determine that the data transfer was made without error, the data can be used in your ladder program.

## Module Operation

The module's input circuitry consists of eight differential analog inputs, multiplexed into an A/D convertor. The A/D convertor reads the analog input signals and converts them to a digital value. The input circuitry also continuously samples the CJC sensors and compensates for temperature changes at the cold junction (terminal block).

## Module Addressing

The module requires eight words each in the SLC processor's input and output image tables. Addresses for the module in slot e are as follows:

I:e.0-7 thermocouple/mV or status data for channels 0 to 7, respectively (dependent on bit in configuration word).

O:e.0-7 configuration data for channels 0 to 7, respectively.

See Module Addressing on page 3-2 to see the module's image table.

## Block Diagram

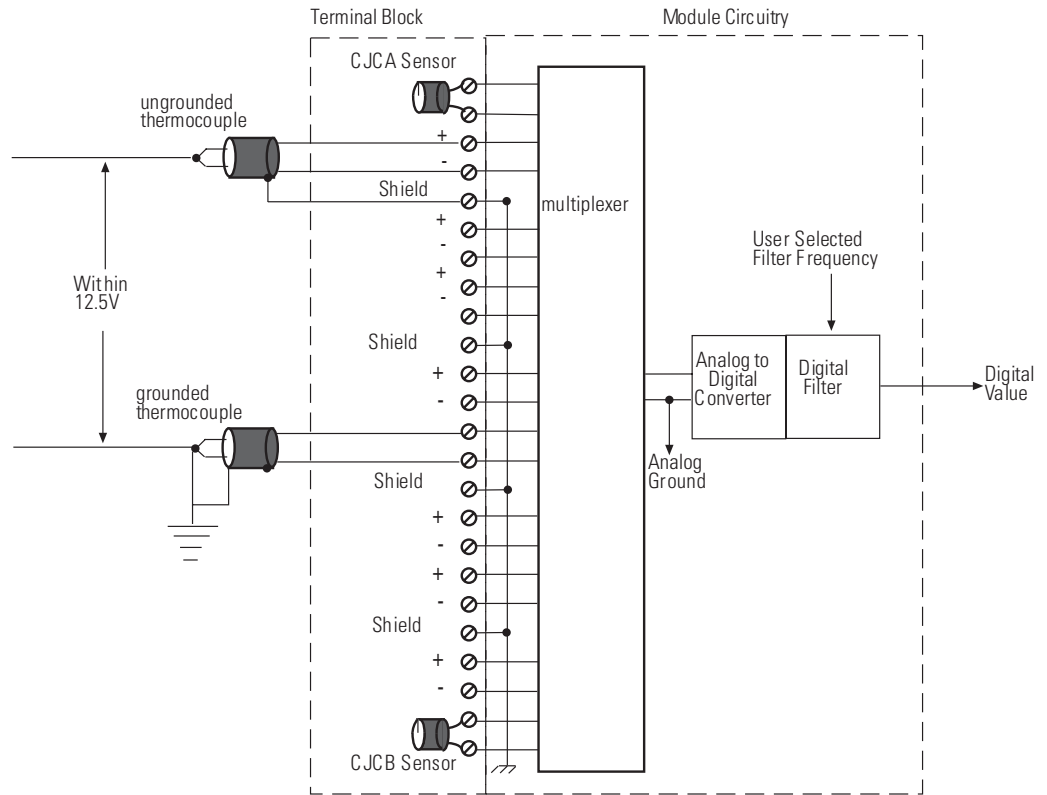

### IMPORTANT

When using multiple thermocouples, the potential between any two channels cannot exceed the channel-to-channel differential voltage (12.5 volts). For more information, see Appendix B.



## Linear Millivolt Device Compatibility<sup>(1)</sup>

A large number of millivolt devices may be used with the 1746-NT8 module. For this reason we do not specify compatibility with any particular device.

However, millivolt applications often use strain gage bridges. A resistive voltage divider using fixed resistors is recommended for this application. The circuit diagram below shows how this connection is made.

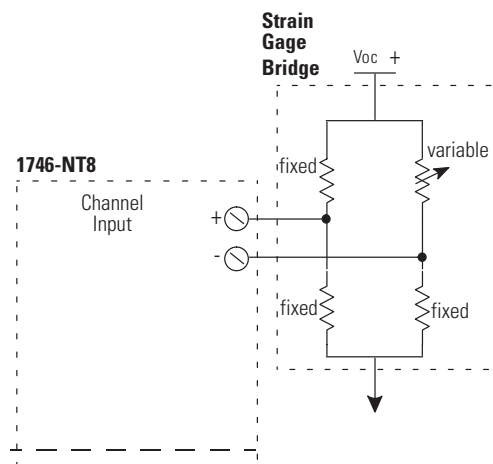

### TIP

The resistors should be selected to ensure that the differential input voltage is less than or equal to  $\pm 100$  mV.

(1) Output impedance of input device must be less than 100 ohm to meet accuracy specifications.



## Installing And Wiring Your Module

Read this chapter to install and wire your module. This chapter covers:

- avoiding electrostatic damage
- determining power requirements
- installing the module
- wiring signal cables to the module's terminal block

### Electrostatic Damage

Electrostatic discharge can damage semiconductor devices inside this module if you touch backplane connector pins. Guard against electrostatic damage by observing the following precautions:

---

**ATTENTION****Electrostatically Sensitive Components**

- Before handling the module, touch a grounded object to rid yourself of electrostatic charge.
- Handle the module from the front, away from the backplane connector. Do not touch backplane connector pins.
- Keep the module in its static-shield container when not in use or during shipment.

Failure to observe these precautions can degrade the module's performance or cause permanent damage.

---

## Power Requirements

The module receives its power through the SLC 500 chassis backplane from the fixed or modular +5 V dc/+24 V dc chassis power supply. The maximum current drawn by the module is shown in the table below.

### Maximum Current Drawn by the Module

5Vdc Amps	24Vdc Amps
0.120	0.070

## Considerations for a Modular System

Place your module in any slot of an SLC 500 modular, or modular expansion chassis, except for the left-most slot (slot 0) reserved for the SLC processor or adapter modules.

When using the module with a *modular system*, add the values shown above to the requirements of all other modules in the SLC to prevent overloading the chassis power supply. Refer to the *SLC 500 Modular Hardware Style User Manual*, publication 1747-UM011.

## Fixed I/O Chassis - I/O Module Compatibility

The following chart depicts the range of current combinations supported by the fixed I/O expansion chassis. To use it, find the backplane current draw and operating voltage for both modules being used in the chassis. These specifications are found in the table alongside the chart.

Next, plot each of the currents on the chart below. If the point of intersection falls within the operating region, the combination is valid. If not, the combination cannot be used in a 2-slot, fixed I/O chassis.

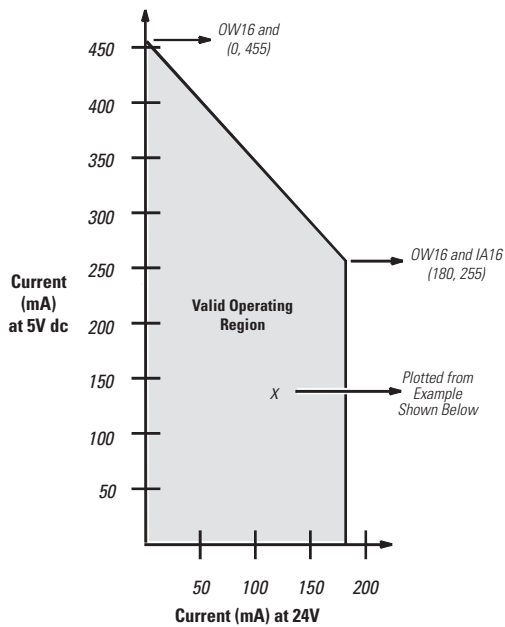

- Example: Plot IN16 and NIO4V  
 IN16 = 0.085 at 5V dc and 0A at 24V dc  
 NIO4V = 0.055A at 5V dc and 0.115A at 24V dc
1. Add current draws of both modules at 5V dc to get 0.14 A (140 mA).
  2. Plot this point on the chart above (140 mA at 5V dc).
  3. Add current draws of both modules at 24V dc to get 0.115 A (115 mA).
  4. Plot current draw at 24V dc (115 mA at 24V dc).
  5. Note the point of intersection on the chart above (marked x). This combination falls within the valid operating region for the fixed I/O chassis.

**Important: The 1747-N04I and 1746-N04V analog output modules may require an external power supply.**

Module Current Draw - Power Supply Loading					
I/O Module	5V	24V	I/O Module	5V	24V
BAS	.150	.040	NI4	.025	.085
BASn	.150	.125	NI8	.200	.100
DCM	.360	.000	NIO4I	.055	.145
FI O4I	.055	.150	NIO4V	.055	.115
FI O4V	.055	.120	NO4I	.055	.195
HS	.300	.000	NO4V	.055	.145
HSTP 1	.200	.000	NO8I	.120	.250*
IA4	.035	.000	NO8V	.120	.160*
IA8	.050	.000	NR4	.050	.050
IA16	.085	.000	NR8	.100	.055
IB8	.050	.000	NT4	.060	.040
IB16	.085	.000	NT8	.120	.070
IB32	.106	.000	OA16	.370	.000
IC 16	.085	.000	OA8	.185	.000
IG 16	.140	.000	OAP 12	.370	.000
IH16	.085	.000	OB8	.135	.000
IM4	.035	.000	OB16	.280	.000
IM8	.050	.000	OB16E	.135	.000
IM16	.085	.000	OB32	.452	.000
IN16	.085	.000	OBP8	.135	.000
IO 4	.030	.025	OBP16	.250	.000
IO 8	.060	.045	OG16	.180	.000
IO 12	.090	.070	OV8	.135	.000
ITB16	.085	.000	OV16	.270	.000
ITV16	.085	.000	OV32	.452	.000
IV8	.050	.000	OVP 16	.250	.000
IV16	.085	.000	OW16	.170	.180
IV32	.106	.000	OW4	.045	.045
KE	.150	.040	OW8	.085	.090
KE n	.150	.125	OX8	.085	.090

\* w/jumper set to rack, otherwise 0.0 mA.

When using the BAS or KE module to supply power to a 1747-AIC Link Coupler, the link coupler draws its power through the module. The higher current drawn by the AIC at 24V dc is shown in the table as BASn (BAS networked) and KEn (KE networked). Be sure to use these current draw values if the application uses the BAS or KE module in this way.

## General Considerations

Most applications require installation in an industrial enclosure to reduce the effects of electrical interference. Thermocouple inputs are highly susceptible to electrical noises due to the small amplitudes of their signal (microvolt/°C).

Group your modules to minimize adverse effects from radiated electrical noise and heat. Consider the following conditions when selecting a slot for the thermocouple module. Position the module:

- in a slot away from sources of electrical noise such as recontact switches, relays, and AC motor drives
- away from modules which generate significant radiated heat, such as the 32-point I/O modules

In addition, route shielded twisted pair thermocouple or millivolt input wiring away from any high voltage I/O wiring.

Remember that in a modular system, the processor or communications adapter always occupies the first slot of the chassis.

## Module Installation and Removal

### ATTENTION



### Possible Equipment Operation

Before installing or removing your module, always disconnect power from the SLC 500 system and from any other source to the module (in other words, do not 'hot swap' your module), and disconnect any devices wired to the module.

Failure to observe this precaution can cause unintended equipment operation and damage.

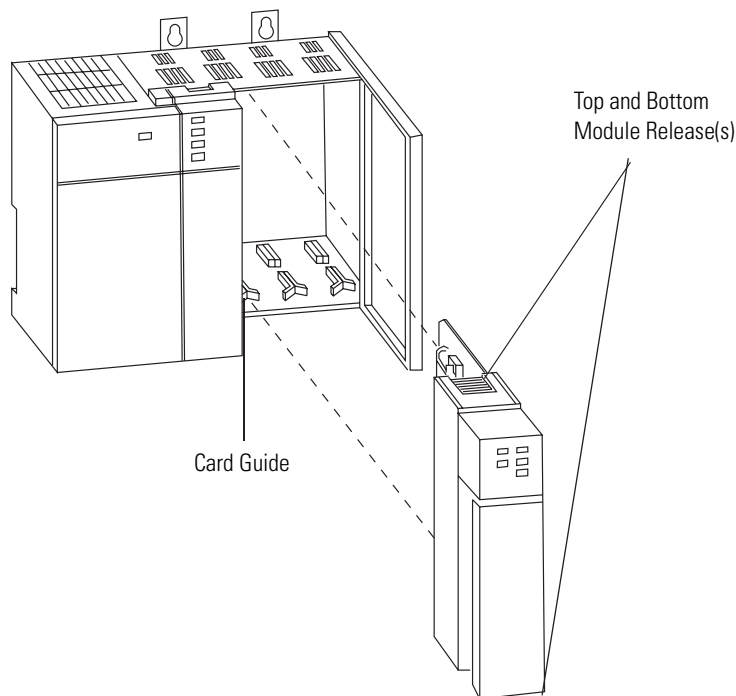

To insert your module into the chassis, follow these steps:

1. Before installing the module, connect the ground wire to TB1. See the figure on page 2-10.
2. Align the circuit board of your module with the card guides at the top and bottom of the chassis.
3. Slide your module into the chassis until both top and bottom retaining clips are secure. Apply firm even pressure on your module to attach it to its backplane connector. Never force your module into the slot.

4. Cover all unused slots with the Card Slot Filler, Allen-Bradley part number 1746-N2.

### **Terminal Block Removal**

To remove the terminal block:

1. Loosen the two terminal block release screws. To avoid cracking the terminal block, alternate between screws as you remove them.
2. Using a screwdriver or needle-nose pliers, carefully pry the terminal block loose. When removing or installing the terminal block be careful not to damage the CJC sensors.

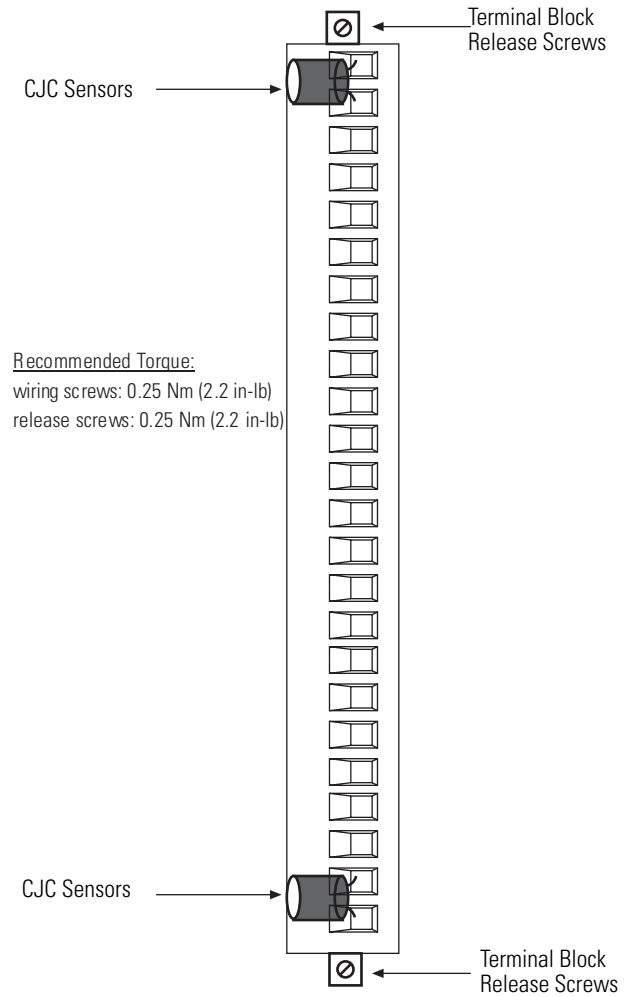

*Terminal block diagram with CJC sensors***ATTENTION****Possible Equipment Operation**

Before wiring your module, always disconnect power from the SLC 500 system and from any other source to the module.

Failure to observe this precaution can cause unintended equipment operation and damage.

## Wiring Your Module

Follow these guidelines to wire your input signal cables:

- Power, input, and output (I/O) wiring must be in accordance with Class 1, Division 2 wiring methods [Article 501-4(b) of the National Electrical Code, NFPA 70] and in accordance with the authority having jurisdiction.
- Route thermocouple and millivolt signal wires as far as possible from sources of electrical noise, such as motors, transformers, contactors, and ac devices. As a general rule, allow at least 6 in. (about 15.2 cm) of separation for every 120V ac of power.
- Routing the field wiring in a grounded conduit can reduce electrical noise further.
- If the field wiring must cross ac or power cables, ensure that they cross at right angles.
- For high immunity to electrical noise, use Belden™ 8761 (shielded, twisted pair) or equivalent wire for millivolt sensors; or use shielded, twisted pair thermocouple extension lead wire specified by the thermocouple manufacturer. Using the incorrect type of convention thermocouple extension wire or not following the correct polarity may cause invalid readings.
- Ground the shield drain wire at only one end of the cable. The preferred location is at the shield connections on the terminal block. (Refer to IEEE Std. 518, Section 6.4.2.7 or contact your sensor manufacturer for additional details.)
- Keep all unshielded wires as short as possible.
- Excessive tightening can strip a screw. Tighten screws to 0.25 Nm (2.2 in-lb) or less, based on UL 1059, CSA C22.2 No. 158, VDE 0110B 2.79 standards.
- Follow system grounding and wiring guidelines found in your *SLC 500 Modular Hardware Style User Manual*, publication 1747-UM011 or *1747-SLC 500 Fixed Hardware Style User Manual*, publication 1747-6.21.

## Preparing and Wiring the Cables

To prepare and connect cable leads and drain wires, follow these steps:

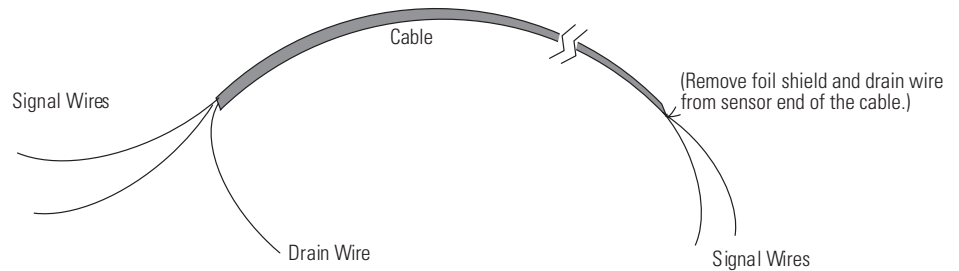

1. At each end of the cable, strip some casing to expose individual wires.
2. Trim signal wires to 5-inch lengths beyond the cable casing. Strip about 3/16 inch (4.76 mm) of insulation to expose the ends of the wires.
3. At the module end of the cables:
  - extract the drain wire and signal wires
  - remove the foil shield
  - bundle the input cables with a cable strap
4. Connect pairs of drain wires together:
  - Channels 0 and 1
  - Channels 2 and 3
  - Channels 4 and 5
  - Channels 6 and 7

Keep drain wires as short as possible.

5. Connect the drain wires to the shield inputs of the terminal block if appropriate for thermocouple used.
  - Channel 0 and 1 drain wires to pin 5
  - Channel 2 and 3 drain wires to pin 10
  - Channel 4 and 5 drain wires to pin 15
  - Channel 6 and 7 drain wires to pin 20

6. Connect the signal wires of each channel to the terminal block.

---

**IMPORTANT**

Only after verifying that your connections are correct for each channel, trim the lengths to keep them short. Avoid cutting leads too short.

---

7. Connect TB1 chassis ground connector to the nearest chassis mounting bolt with 14 gauge wire. (Looking at the face of the module, TB1 is near the lower part of the terminal block on the primary side of the PCB.)

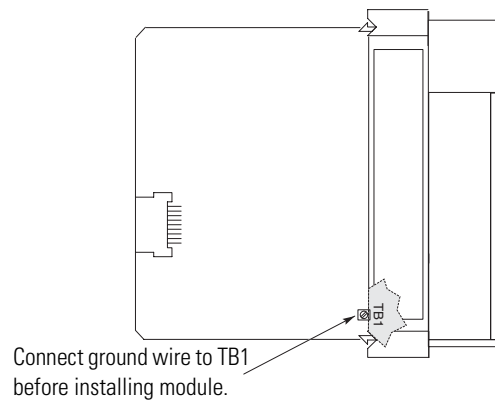

8. At the sensor end of cables from thermocouple/mV devices:
  - remove the drain wire and foil shield
  - apply shrink wrap as an option
  - connect to mV devices keeping the leads short.

---

**IMPORTANT**

If noise persists, try grounding the opposite end of the cable. Ground one end only.

---

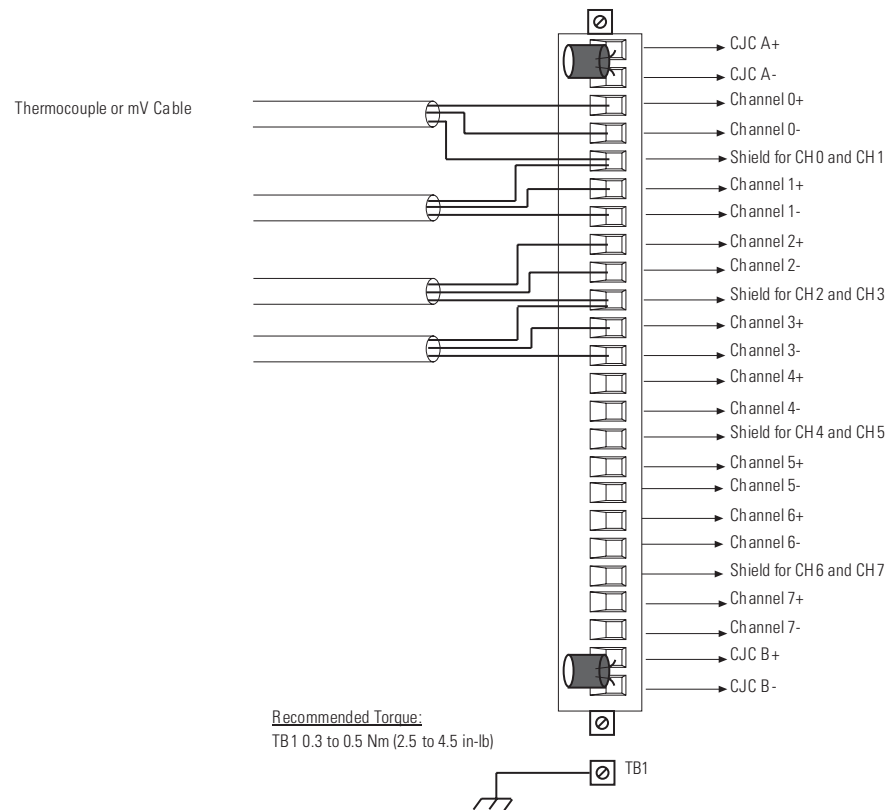
*Terminal Block Diagram with Input Cable*

The module also has a ground terminal TB1, which should be grounded to a chassis mounting bolt with 14-gauge wire.

## Cold-Junction Compensation (CJC)

### ATTENTION



### Possible Equipment Operation

Do not remove or loosen the cold-junction compensating temperature transducers located on the terminal block. Both CJC's are required to ensure accurate thermocouple input readings at each channel. The module will not operate in thermocouple mode if a CJC is not connected.

Failure to observe this precaution can cause unintended equipment operation and damage.

To obtain accurate readings from each of the channels, the cold-junction temperature (temperature at the module's terminal junction between the thermocouple wire and the input channel) must be compensated for. Two cold-junction compensating sensors have been integrated in the removable terminal block. They must remain installed.



## Considerations Before Using Your Module

This chapter explains how the module and the SLC processor communicate through the processor's I/O image tables. It also describes the module's input filter characteristics. Topics discussed include:

- module ID code
- module addressing
- channel filter frequency selection
- channel turn-on, turn-off, and reconfiguration times
- response to slot disabling

### Module ID Code

The module ID code is unique number assigned to each 1746 I/O module. The ID code defines the type of I/O module and the number of words used in the processor's I/O image table.

The module ID code for the 1746-NT8 module is 3533.

No special I/O configuration is required. The module ID automatically assigns the correct number of input and output words.

## Module Addressing

The following memory map shows you how the SLC processor's output and input tables are defined for the module.

### Image Table

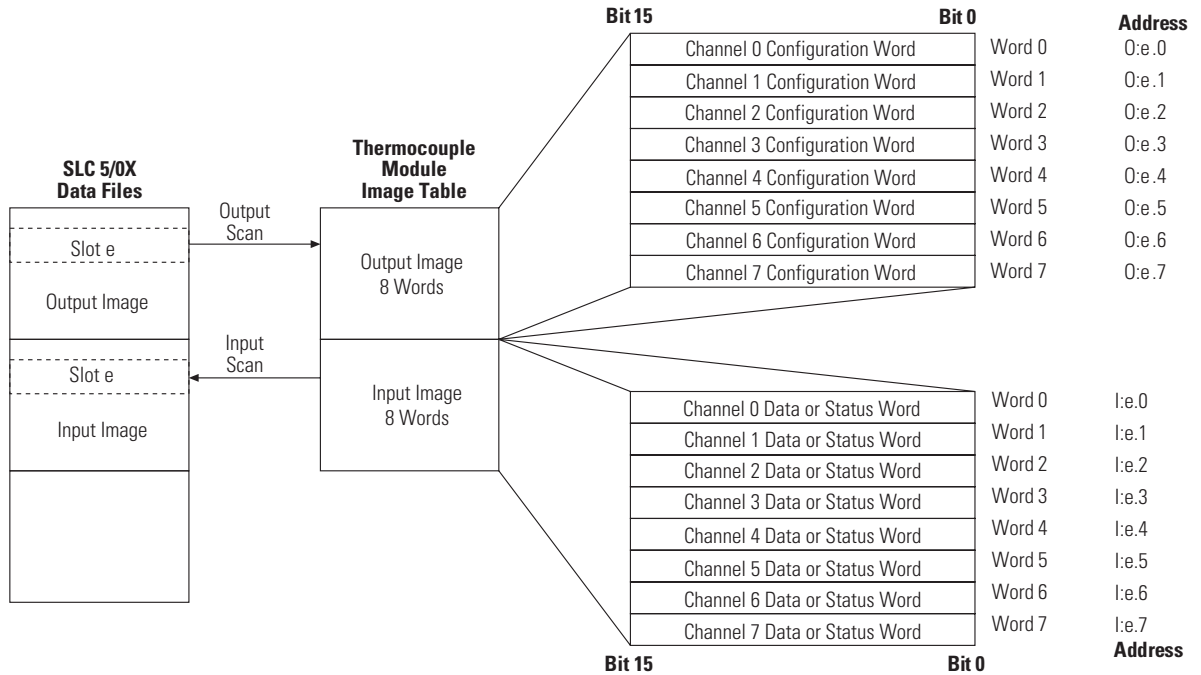

## Output Image - Configuration Words

Eight words of the SLC processor's output image table are reserved for the module. Output image words 0 through 7 are used to configure the module's input channels 0 through 7. Each output image word configures a single channel and can be referred to as a configuration word. Each word has a unique address based on the slot number assigned to the module.

**Example Address** - If you want to configure channel 2 on the module located in slot 4 in the SLC chassis, your address would be O:4.2.

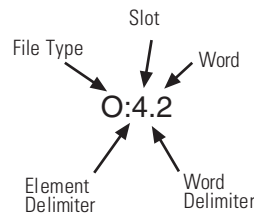



Chapter 4 provides detailed bit information about the data content of the configuration word.

## Input Image - Data Words and Status Words

Eight words of the SLC processor's input image table are reserved for the module. Input image words are multiplexed since each channel has one data word and one status word. The corresponding configuration word selects whether the channel status or channel data is in the input image word.

Status bits for a particular channel reflect the configuration settings that you entered into the configuration (output image) word for that channel. To receive valid status, the channel must be enabled and the module must have stored a valid configuration word for that channel.

Each input image word has a unique address based on the slot number assigned to the module.

**Example Address** - To obtain the status/data word of channel 2 (input word 2) of the module located in slot 4 in the SLC chassis use address I:4:2.

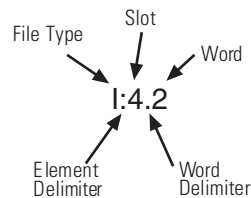

Chapter 4 provides detailed bit information about the content of the data word and the status word.

## Channel Filter Frequency Selection

The thermocouple module uses a digital filter that provides high-frequency noise rejection for the input signals. The digital filter is programmable, allowing you to select from four filter frequencies for each channel. The digital filter provides the highest noise rejection at the selected filter frequency. The graphs to follow show the input channel frequency response for each filter frequency selection.

Selecting a low value (i.e. 10 Hz) for the channel filter frequency provides the best noise rejection for a channel, but it also increases the channel update time. Selecting a high value for the channel filter frequency provides lower noise rejection, but decreases the channel update time.

The following table shows the available filter frequencies, cut-off frequency, step response, and a DC effective resolution for each filter frequency.

**Cut-off frequency, Step Response Time, and Effective Resolution (Based on Filter Frequency)**

Filter Frequency	Cut-Off Frequency	Step Response	ADC Effective Resolution
10 Hz	2.62 Hz	400 ms	20.5
50 Hz	13.1 Hz	80 ms	19.0
60 Hz	15.72 Hz	66.7 ms	19.0
250 Hz	65.5 Hz	16 ms	15.5

The step response is calculated by a  $4 \times (1/\text{filter frequency})$  settling time.

### Channel Cut-Off Frequency

The channel filter frequency selection determines a channel's cut-off frequency, also called the -3 dB frequency. The cut-off frequency is defined as the point on the input channel frequency response curve where frequency components of the input signal are passed with 3 dB of attenuation. All frequency components at or below the cut-off frequency are passed by the digital filter with less than 3 dB of attenuation. All frequency components above the cut-off frequency are increasingly attenuated, as shown in the graphs on page 3-5.

The cut-off frequency for each input channel is defined by its filter frequency selection. The table above shows the input channel cut-off frequency for each filter frequency. Choose a filter frequency so that your fastest changing signal is below that of the filter's cut-off frequency. The cut-off frequency should not be confused with update time. The cut-off frequency relates how the digital filter attenuates frequency components of the input signal. The update time defines the rate at which an input channel is scanned and its channel data word updated.

**Signal Attenuation with 10 Hz Input Filter**

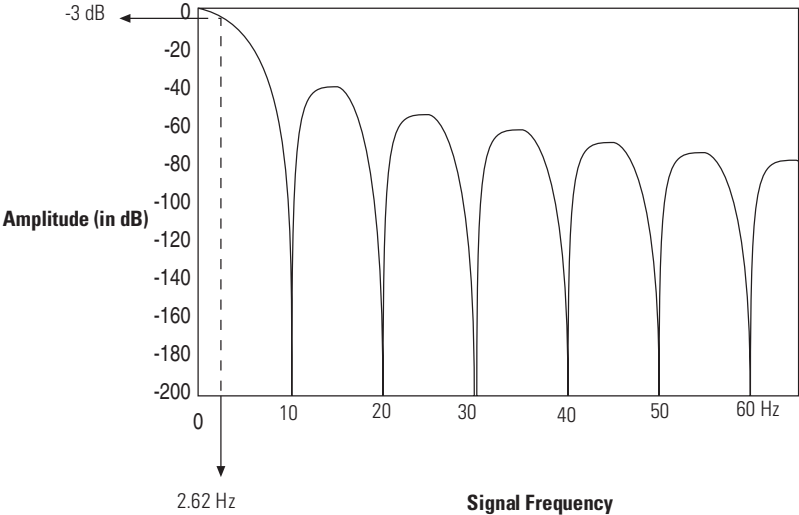

**Signal Attenuation with 50 Hz Input Filter**

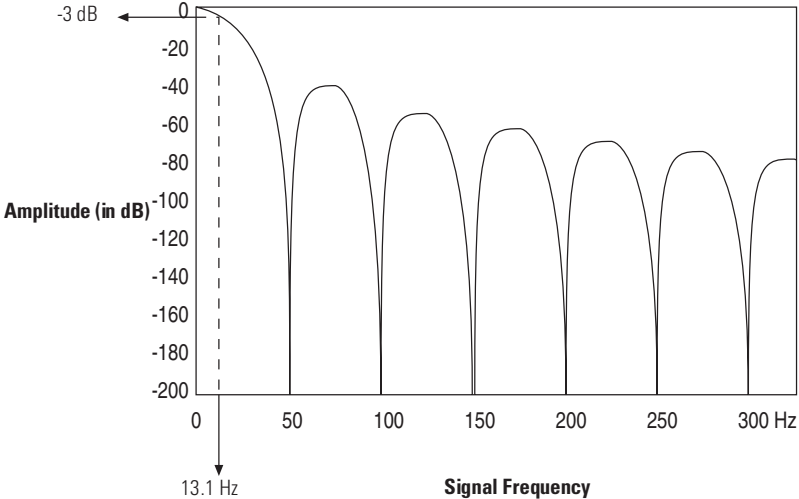

### Signal Attenuation with 60 Hz Input Filter

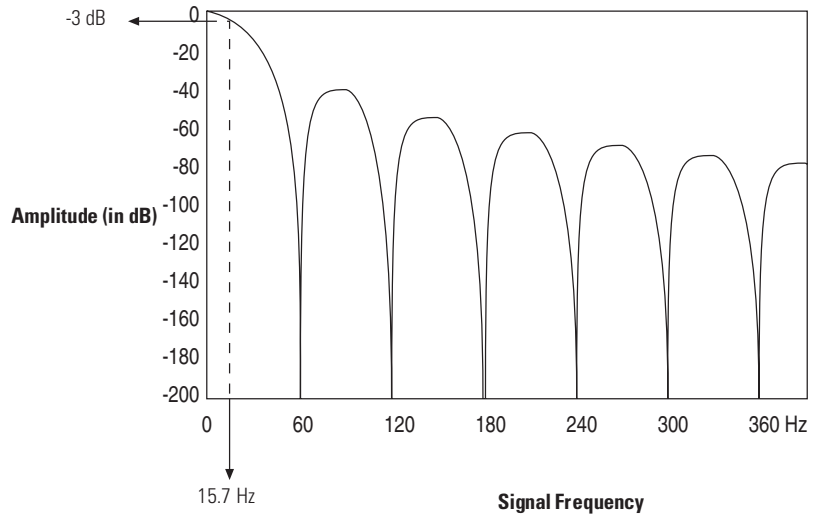

### Signal Attenuation with 250 Hz Input Filter

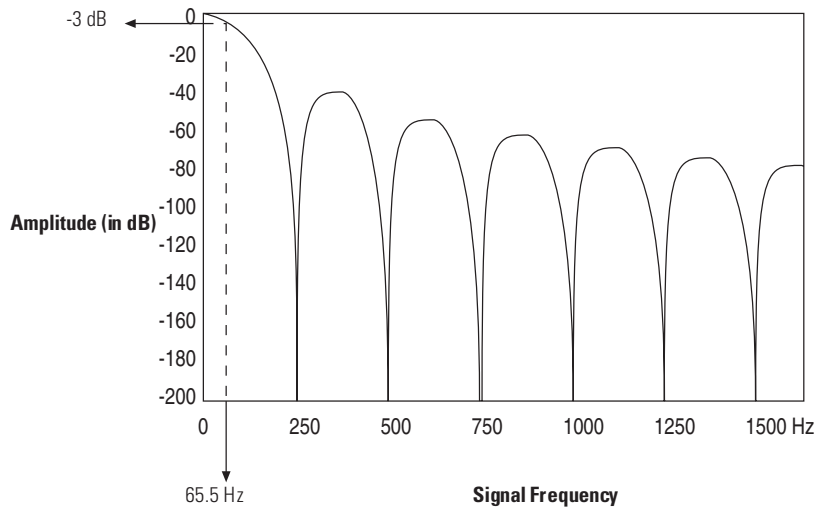

## Channel Step Response

The channel filter frequency determines the channel's step response. The step response is time required for the analog input signal to reach 95% of its expected, final value given a full-scale step change in the input signal. This means that if an input signal changes faster than the channel step response, a portion of that signal will be attenuated by the channel filter. The table on page 3-4 shows the step response for each filter frequency.

# Update Time

The thermocouple module update time is defined as the time required for the module to sample and convert the input signals of all enabled input channels and make the resulting data values available to the SLC processor. It can be calculated by adding the sum of all enabled sample times, plus a CJC update time.

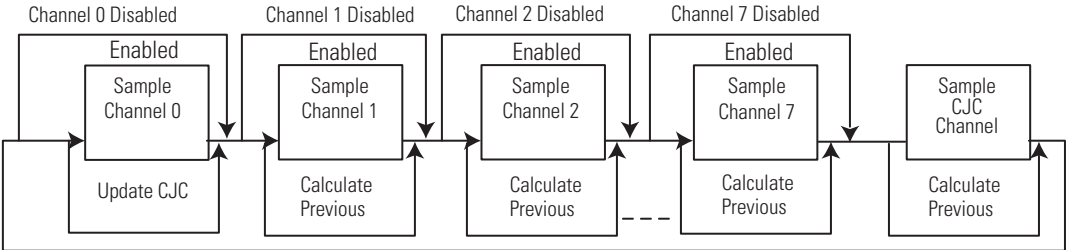

The following table shows the channel sampling time for each filter frequency. It also gives the CJC update time.

### Channel Sampling Time

Channel Sampling Time for Each Filter Frequency (all values ±1 ms)				
CJC Update Time	250 Hz Filter	60 Hz Filter	50 Hz Filter	10 Hz Filter
290 ms	66 ms	125 ms	140 ms	470 ms

The times above include a settling time necessary between input channel readings. The sampling times for filter frequencies listed do not include a 45 ms open-circuit detection time utilized when the channel is configured for open-circuit detection. CJC open-circuit detection does not require the additional 45 ms settling time.

The fastest module update time occurs when only one channel with a 250 Hz filter frequency is enabled.

$$\text{Module update time} = 290 \text{ ms} + 66 \text{ ms} = 356 \text{ ms}$$

The slowest module update time occurs when eight channels, each using a 10 Hz filter frequency, are enabled.

$$\text{Module update time} = 290 \text{ ms} + 470 \text{ ms} + 470 \text{ ms} + 470 \text{ ms} + 470 \text{ ms} + 470 \text{ ms} + 470 \text{ ms} + 470 \text{ ms} = 4.05 \text{ s}$$

### Update Time Calculation Example

The following example shows how to calculate the module update time for the given configuration:

Channel 0 configured for 250 Hz filter frequency, enabled  
 Channel 1 configured for 250 Hz filter frequency, enabled  
 Channel 2 configured for 50 Hz filter frequency, enabled  
 Channel 3 through 7 disabled

Using the values from the table on page 3-7, add the sum of all enabled channel sample times, plus one CJC update time.

Channel 0 sampling time	=	66 ms
Channel 1 sampling time	=	66 ms
Channel 2 sampling time	=	140 ms
CJC update time	=	290 ms
Module update time	=	562 ms

### Channel Turn-On, Turn-Off, and Reconfiguration Times

The time required for the module to recognize a new configuration for a channel is generally one module update time plus 890 µs per newly configured channel. If the filter frequency selected for the newly enabled, configured channel is new to the module, then auto-calibration is performed following configuration recognition.

Turn-off time requires up to one module update time.

Reconfiguration time is the same as turn-on time.

### Auto-calibration

Auto-calibration is performed by the module to correct for drift errors over temperature. Auto-calibration occurs immediately following configuration of a previously unselected filter frequency, and generally every two minutes for all selected filter frequencies of the system. The time required to perform auto-calibration is defined as follows:

#### Auto-calibration Time

250 Hz Filter	60 Hz Filter	50 Hz Filter	10 Hz Filter
325 ms	525 ms	585 ms	1.975 s

CJC sensors are acquired at 60 Hz to maximize the trade-off between resolution and update rate. For example, if some channels are acquired at 250 Hz and some are acquired at 50 Hz, then the total auto-calibration time would be:

Frequency	Auto-Calibration
250 Hz	325 ms
60 Hz	525 ms
50 Hz	585 ms
	1.435 s Total

During auto-calibration, input values are not updated.

## Response to Slot Disabling

By writing to the status file in the modular SLC processor, you can disable any chassis slot. Refer to your SLC programming manual for the slot disable/enable procedure.

### ATTENTION



### Possible Equipment Operation

Always understand the implications of disabling a module before using the slot disable feature.

Failure to observe this precaution can cause unintended equipment operation.

## Input Response

When a thermocouple slot is disabled, the thermocouple module continues to update its input image table. However, the SLC processor does not read input from a module that is disabled. Therefore, when the processor disables the thermocouple module slot, the module inputs appearing in the processor image table remain in their last state, and the module's updated image table is not read. When the processor re-enables the module slot, the current state of the module inputs are read by the processor during the subsequent scan.

## Output Response

The SLC processor may change the thermocouple module output data (configuration) as it appears in the processor output image. However, this data is not transferred to the thermocouple module. The outputs are held in their last state. When the slot is re-enabled, the data in the processor image is transferred to the thermocouple module.





## Channel Configuration, Data, and Status

Read this chapter to:

- configure each input channel
- check each input channel's configuration and status

### Channel Configuration

Channel configuration words appear in the SLC processor's output image table as shown below. Words 0 to 7 correspond to module channels 0 to 7.

After module installation, configure each channel to establish the way the channel operates (e.g., thermocouple type, temperature units, etc.). Configure the channel by setting bits in the configuration word using your programming device. The SLC configuration words are shown below.

#### SLC Output Image (Configuration) Words

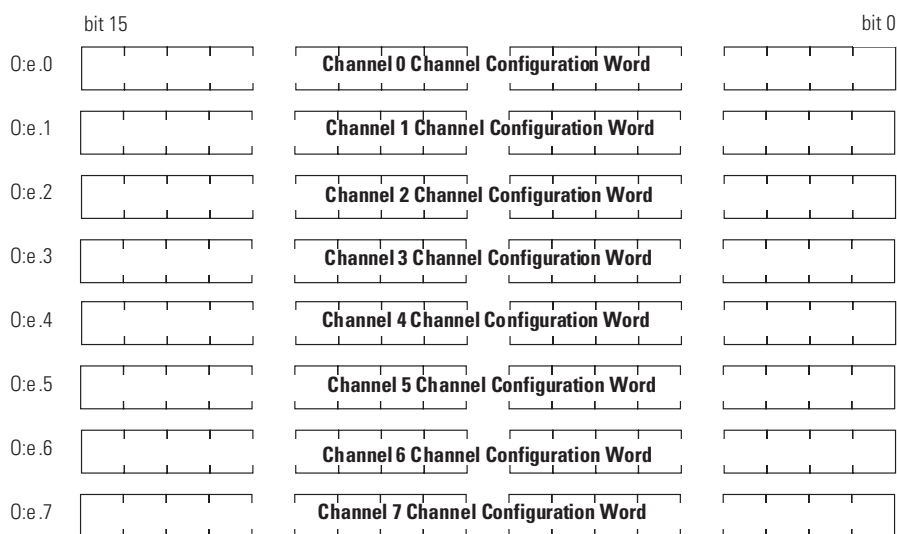

e = slot number of the module

The configuration word default settings are all zero. Next, we describe how you set configuration bits of a channel configuration word to set up the following channel parameters:

- data format such as engineering units, counts, or scaled-for-PID
- how the channel should respond to a detected open-input circuit
- filter frequency selection
- temperature units in °C or °F
- whether the channel is enabled or disabled
- whether status or data information is selected for the module's input image table

## Channel Configuration Procedure

The channel configuration word consists of bit fields, the settings of which determine how the channel operates. This procedure looks at each bit field separately and helps configure a channel for operation. Refer to the chart on page 4-4 and the bit field descriptions that follow for complete configuration information.

**TIP**

When using RSLogix 500 version 6.10 or higher, you can use the software's I/O wizard to configure the NT8 channels. Refer to Appendix C for more information.

1. Determine which channels are used in your program and enable them. Place a one in bit 0 if the channel is to be enabled. Place a zero in bit 0 if the channel is to be disabled.
2. Determine the input device type (J, K, etc. thermocouple) (or mV) for a channel and enter its respective four-digit binary code in bit field 1 through 4 of the channel configuration word.
3. Select a data format for the data word. Your selection determines how the analog input value from the A/D converter will be expressed in the data word. Enter your two-digit binary code in bit field 5 and 6 of the channel configuration word.
4. Determine the desired state for the channel data word if an open-circuit condition is enabled and detected for that channel. Enter the two-digit binary code in bit field 7 and 8 of the channel configuration word.

5. If the channel is configured for thermocouple inputs, determine if the channel data word should read in degrees Fahrenheit or degrees Celsius and enter a one or a zero in bit 9 of the configuration word. If the channel is configured for a mV analog sensor, enter a zero in bit 9.
6. Determine the desired input filter frequency for the channel and enter the two-digit binary code in bits 10 and 11 of the channel configuration word. A lower filter frequency increases the channel update time, but also increases the noise rejection and channel resolution. A higher filter frequency decreases the channel update time, but also decreases the noise rejection and effective resolution.
7. Ensure that bits 12 through 14 contain zeros.
8. Determine whether the channel input image word should contain data or status. Place a one in bit 15 if channel data is desired. Place a zero in bit 15 if status is desired.
9. Build the channel configuration word for every channel on each thermocouple/mV module repeating the procedures given in steps 1 through 8.
10. Enter this configuration into your ladder program and download it to the thermocouple module.

A detailed explanation appears in the following table:

**Channel Configuration Word (0:e.0 through 0:e.7) - Bit Definitions**

To Select		Make these bit settings															
		15	14	13	12	11	10	9	8	7	6	5	4	3	2	1	0
<b>Channel Enable</b>	<b>Channel Disable</b>																0
	<b>Channel Enable</b>																1
<b>Input Type</b>	<b>Thermocouple J</b>												0	0	0	0	
	<b>Thermocouple K</b>												0	0	0	1	
	<b>Thermocouple T</b>												0	0	1	0	
	<b>Thermocouple E</b>												0	0	1	1	
	<b>Thermocouple R</b>												0	1	0	0	
	<b>Thermocouple S</b>												0	1	0	1	
	<b>Thermocouple B</b>												0	1	1	0	
	<b>Thermocouple N</b>												0	1	1	1	
	<b>-50 to +50 mV</b>												1	0	0	0	
	<b>-100 to +100 mV</b>												1	0	0	1	
	<b>Invalid</b>												1	0	1	0	
	<b>Invalid</b>												1	0	1	1	
	<b>Invalid</b>												1	1	0	0	
	<b>Invalid</b>												1	1	0	1	
	<b>Invalid</b>												1	1	1	0	
<b>CJC temperature</b>												1	1	1	1		
<b>Data Format</b>	<b>Engineering Units x 1<sup>(1)</sup></b>											0	0				
	<b>Engineering Units x 10<sup>(1)</sup></b>											0	1				
	<b>Scaled-for-PID</b>											1	0				
	<b>Proportional counts</b>											1	1				
<b>Open Circuit</b>	<b>Zero on open circuit</b>									0	0						
	<b>Max. on open circuit</b>									0	1						
	<b>Min. on open circuit</b>									1	0						
	<b>Disabled</b>									1	1						
<b>Temperature units</b>	<b>°C<sup>(2)</sup></b>							0									
	<b>°F<sup>(2)</sup></b>							1									
<b>Channel filter frequency</b>	<b>10 Hz input filter</b>					0	0										
	<b>50 Hz input filter</b>					0	1										
	<b>60 HZ input filter</b>					1	0										
	<b>250 Hz input filter</b>					1	1										
<b>Unused</b>	<b>Unused<sup>(3)</sup></b>		0	0	0												
	<b>Invalid</b>		1	1	1												
<b>Input Image Type</b>	<b>Status Word</b>	0															
	<b>Data Word</b>	1															

(1) For engineering units x 1, values are expressed in 0.1 degrees or 0.01 mV. For engineering units x 10, values are expressed in 1.0 degrees or 0.1 mV.

(2) When millivolt input type is selected, the bit setting for temperature units is ignored.

(3) Ensure unused bits 12 through 14 are always set to zero.

## Select Channel Enable (Bit 0)

Use the channel enable bit to enable a channel. The thermocouple module only scans enabled channels. To optimize module operation and minimize throughput times, unused channels should be disabled by setting the channel enable bit to zero (default value).

When set (1) the channel enable bit is used by the module to read the configuration word information selected. While the enable bit is set, modification of the configuration word may lengthen the module update time for one cycle. If any change is made to the configuration word, the change is reflected in the status word before new data is valid (described on page 4-11).

While the channel enable bit is cleared (0), the associated channel data/status word values are cleared. After the channel enable bit is set (1), the associated channel data/status word remains cleared until the thermocouple module sets the channel status bit (bit 0) in the channel status word.

## Select Input Types (Bits 1 through 4)

The input type bit field lets you configure the channel for the type of input device you have connected to the module. Valid input devices are types J, K, T, E, R, S, B, and N thermocouple sensors and  $\pm 50$  mV and  $\pm 100$  mV analog input signals. The channel can also be configured to read the cold-junction temperature calculated for that specific channel. When the cold-junction compensation (CJC) temperature is selected, the channel ignores the physical input signal.

## Select Data Format (Bits 5 and 6)

The data format bit field lets you define the expressed format for the channel data word contained in the module input image. The data types are engineering units, scaled-for-PID, and proportional counts.

The **engineering units** allow you to select from two resolutions, x1 or x10. For engineering units x1, values are expressed in 0.1 degrees or 0.01 mV. For engineering units x10, values are expressed in 1.0 degrees or 0.1 mV. (Use the x10 setting to produce temperature readings in whole degrees Celsius or Fahrenheit.)

The **scaled-for-PID** value is the same for millivolt, thermocouple, and CJC input types. The input signal range is proportional to your selected input type and scaled into a 0 through 16,383 range, which is standard to the SLC PID algorithm.

The **proportional counts** are scaled to fit the defined temperature or voltage range. The input signal range is proportional to your selected input and scaled into a -32,768 to 32,767 range.

### Using Scaled-for-PID and Proportional Counts

The thermocouple module provides eight options for displaying input channel data. These are 0.1°F, 0.1°C, 1°F, 1°C, 0.01 mV, 0.1 mV, Scaled-for-PID, and Proportional Counts. The first six options represent real Engineering Units displayed by the 1746-NT8 and do not require explanation. The Scaled-for-PID and Proportional Counts selections provide the highest NT8 display resolution, but also require you to manually convert the channel data to real Engineering Units.

The equations below show how to convert from Scaled-for-PID to Engineering Units, Engineering Units to Scaled-for-PID, Proportional Counts to Engineering Units, and Engineering Units to Proportional Counts. To perform the conversions, use the defined temperature or millivolt range for the channel's input type. See the Channel Data Word Format table on page 4-8. The lowest possible value for an input type is  $S_{LOW}$ , and the highest possible value is  $S_{HIGH}$ .

### Effective Resolutions

The effective resolution for an input channel depends upon the filter frequency selected for that channel.

## Scaling Examples

<b>Scaled-for-PID to Engineering Units</b>	
<b>Equation:</b>	Engineering Units Equivalent = $S_{LOW} + [(S_{HIGH} - S_{LOW}) \times (\text{Scaled-for-PID value displayed} / 16384)]$
<b>Data:</b>	Assume type J input type, scaled-for-PID display type, channel data = 3421. Want to calculate °C equivalent. From Channel Data Word Format table, $S_{LOW} = -210^{\circ}\text{C}$ and $S_{HIGH} = 760^{\circ}\text{C}$ .
<b>Solution:</b>	Engineering Units Equivalent = $-210^{\circ}\text{C} + [(760^{\circ}\text{C} - (-210^{\circ}\text{C})) \times (3421 / 16384)] = -7.46^{\circ}\text{C}$ .
<b>Engineering Units to Scaled-for-PID</b>	
<b>Equation:</b>	Scaled-for-PID Equivalent = $16384 \times [(\text{Engineering Units desired} - S_{LOW}) / (S_{HIGH} - S_{LOW})]$
<b>Data:</b>	Assume type J input type, scaled-for-PID display type, desired channel temp. = $344^{\circ}\text{C}$ . Want to calculate Scaled-for-PID equivalent. From Channel Data Word Format table, $S_{LOW} = -210^{\circ}\text{C}$ and $S_{HIGH} = 760^{\circ}\text{C}$ .
<b>Solution:</b>	Scaled-for-PID Equivalent = $16384 \times [(344^{\circ}\text{C} - (-210^{\circ}\text{C})) / (760^{\circ}\text{C} - (-210^{\circ}\text{C}))] = 9357$
<b>Proportional Counts to Engineering Units</b>	
<b>Equation:</b>	Engineering Units Equivalent = $S_{LOW} + \{(S_{HIGH} - S_{LOW}) \times [(\text{Proportional Counts value displayed} + 32768) / 65536]\}$
<b>Data:</b>	Assume type E input type, proportional counts display type, channel data = 21567. Want to calculate °F equivalent. From Channel Data Word Format table, $S_{LOW} = -454^{\circ}\text{F}$ and $S_{HIGH} = 1832^{\circ}\text{F}$
<b>Solution:</b>	Engineering Units Equivalent = $-454^{\circ}\text{F} + \{(1832^{\circ}\text{F} - (-454^{\circ}\text{F})) \times [(21567 + 32768) / 65536]\} = 1441.3^{\circ}\text{F}$
<b>Engineering Units to Proportional Counts</b>	
<b>Equation:</b>	Proportional Counts Equivalent = $\{65536 \times [(\text{Engineering Units desired} - S_{LOW}) / (S_{HIGH} - S_{LOW})]\} - 32768$
<b>Data:</b>	Assume type E input type, proportional counts display type, desired channel temp. = $1000^{\circ}\text{F}$ . Want to calculate Proportional Counts equivalent. From Channel Data Word Format table, $S_{LOW} = -454^{\circ}\text{F}$ and $S_{HIGH} = 1832^{\circ}\text{F}$ . Proportional Counts Equivalent = $\{65536 \times [1000^{\circ}\text{F} - (-454^{\circ}\text{F}) / (1832^{\circ}\text{F} - (-454^{\circ}\text{F})]\} - 32768 = 8916$ .
<b>Solution:</b>	Proportional Counts Equivalent = $\{65536 \times [1000^{\circ}\text{F} - (-454^{\circ}\text{F}) / (1832^{\circ}\text{F} - (-454^{\circ}\text{F})]\} - 32768 = 8916$ .

## 1746-NT8 Thermocouple Module - Channel Data Word Format

## Data Format

Input Type	Engineering Units x10		Engineering Units x1		Scaled for PID	Proportional Counts
	°Celsius	°Fahrenheit	°Celsius	°Fahrenheit		
J	-210 to +760	-346 to +1400	-2100 to +7600	-3460 to +14000	0 to +16383	-32768 to +32767
K	-270 to +1370	-454 to +2498	-2700 to +13700	-4540 to +24980	0 to +16383	-32768 to +32767
T	-270 to +400	-454 to +752	-2700 to +4000	-4540 to +7520	0 to +16383	-32768 to +32767
E	-270 to +1000	-454 to +1832	-2700 to +10000	-4540 to +18320	0 to +16383	-32768 to +32767
R	0 to +1768	+32 to +3214	0 to +17680	+320 to +32140	0 to +16383	-32768 to +32767
S	0 to +1768	+32 to +2372	0 to +17680	+320 to +32140	0 to +16383	-32768 to +32767
B	+300 to +1820	+572 to +3308	+3000 to +18200	+5720 to +3276.7 <sup>(2)</sup>	0 to +16383	-32768 to +32767
N	0 to +1300	+32 to +2372	0 to +13000	+320 to +23720	0 to +16383	-32768 to +32767
±50 mV <sup>(1)</sup>	-500 to +500	-500 to +500	-5000 to +5000	-5000 to +5000	0 to +16383	-32768 to +32767
±100 mV <sup>(1)</sup>	-1000 to +1000	-1000 to +1000	-10000 to +1000	-10000 to +10000	0 to +16383	-32768 to +32767
CJC Sensor	-25 to +105	-13 to +221	-250 to +1050	-130 to +2210	0 to +16383	-32768 to +32767

(1) When millivolts are selected, the temperature setting is ignored. Analog input data is the same for either °C or °F selection.

(2) Type B thermocouple cannot be represented in engineering units x1 (°F) above 3276.7°F. Software treats it as an over range error.

## 1746-NT8 Thermocouple Module - Channel Data Word Resolution

## Data Format

Input Type	Engineering Units x10		Engineering Units x1		Scaled for PID		Proportional Counts	
	°Celsius	°Fahrenheit	°Celsius	°Fahrenheit	°Celsius	°Fahrenheit	°Celsius	°Fahrenheit
J	1°C/step	1°F/step	1°C/step	1°F/step	0.0592°C/step	0.1066°F/step	0.0148°C/step	0.0266°F/step
K	1°C/step	1°F/step	1°C/step	1°F/step	0.1001°C/step	0.1802°F/step	0.0250°C/step	0.0450°F/step
T	1°C/step	1°F/step	1°C/step	1°F/step	0.0409°C/step	0.0736°F/step	0.0102°C/step	0.0184°F/step
E	1°C/step	1°F/step	1°C/step	1°F/step	0.0775°C/step	0.1395°F/step	0.0194°C/step	0.0349°F/step
R	1°C/step	1°F/step	1°C/step	1°F/step	0.1079°C/step	0.1942°F/step	0.0270°C/step	0.0486°F/step
S	1°C/step	1°F/step	1°C/step	1°F/step	0.1079°C/step	0.1942°F/step	0.0270°C/step	0.0486°F/step
B	1°C/step	1°F/step	1°C/step	1°F/step	0.0928°C/step	0.1670°F/step	0.0232°C/step	0.0417°F/step
N	1°C/step	1°F/step	1°C/step	1°F/step	0.0793°C/step	0.1428°F/step	0.0198°C/step	0.0357°F/step
±50 mV <sup>(1)</sup>	0.1mV/step	0.1mV/step	0.1mV/step	0.1mV/step	6.104µV/step	6.104µV/step	1.526µV/step	1.526µV/step
±100 mV <sup>(1)</sup>	0.1mV/step	0.1mV/step	0.1mV/step	0.1mV/step	12.21µV/step	12.21µV/step	3.052µV/step	3.052µV/step
CJC Sensor	1°C/step	1°F/step	1°C/step	1°F/step	0.0079°C/step	0.0143°F/step	0.0020°C/step	0.0036°F/step

(1) When millivolts are selected, the temperature setting is ignored. Analog input data is the same for either °C or °F selection.



**IMPORTANT**

Data resolution is not equivalent to data accuracy. Input accuracy of  $\pm 50 \mu\text{V}$  may span multiple steps for PID and Proportional Counts data types. As an example, a Type B thermocouple temperature range of 0 to 1820°C provides a voltage input range of 0 to 13.82mV to the 1746-NT8. This is a very small input range and, when it is scaled to PID or proportional counts ranges, a small input change results in many counts being changed.

### Select Open-Circuit State (Bits 7 and 8)

The open-circuit bit field lets you define the state of the channel data word when an open-circuit condition is detected for that channel. This feature can be disabled by selecting the disable option.

An open-circuit condition occurs when the thermocouple itself or its extension wire is physically separated or open. This can happen if the wire gets cut or disconnected from terminal block.

If either of the two CJC devices is removed from the terminal block, any input channel configured for either a thermocouple or CJC temperature input is placed in an open-circuit condition. An input channel configured for millivolt input is not affected by CJC open circuit conditions.

The results of the data word in an open-circuit condition depend upon the selection of bits 7 and 8.

If **zero** is selected (00), the channel data word is forced to 0 during an open-circuit condition.

Selecting **maximum** forces the (01) channel data word value to its full scale value during an open-circuit condition. The full scale value is determined by the selected input type and data format.

Selecting **minimum** forces the (10) channel data word value to its low scale value during an open-circuit condition. The low scale value is determined by the selected input type and data format.

**Disabling** the open-circuit selection (11) may result in unintended operation on a failure. Generally, with the open-circuit option disabled, the data word remains unchanged. The open-circuit error bit and the channel LED flags the condition until the error is resolved.

For example, if channel one is configured as a thermocouple type when the CJC breaks in an open-circuit condition, if open-circuit detection is disabled, the data word remains unchanged. If the circuit selection is set at minimum, the data word is set to the low scale value for the range and format.

---

**IMPORTANT**

Enabling the open-circuit function adds approximately 45 ms to the channel update time. Disabling the open circuit detection removes the time adder. CJC sensors do not require the additional time; thus it is recommended that when using a channel for CJC sensor acquisition, the open-circuit selection is enabled.

---

### Select Temperature Units (Bit 9)

The temperature units bit lets you select temperature engineering units for thermocouple and CJC input types. Units are either degrees Celsius (°C) or degrees Fahrenheit (°F). This bit field is only active for thermocouple and CJC input types. It is ignored when millivolt inputs types are selected.

---

**IMPORTANT**

If you are using engineering units (x1 mode) and Fahrenheit temperature units (i.e. 0.1°F), the full scale temperature for thermocouple type B is not achievable with 16-bit signed numerical representation. An over-range error occurs for that channel if it tries to represent the full scale value. The maximum representable temperature is 3276.7°F (instead of 3308°F).

---

### Select Channel Filter Frequency (Bits 10 and 11)

The channel filter frequency bit field lets you select one of four filters available for a channel. The filter frequency affects the channel update time and noise rejection characteristics. A smaller filter frequency increases the channel update time, but also increases the noise rejection and channel resolution. A larger filter frequency decreases the noise rejection, but also decreases the channel update time and channel resolution.

Guidelines for filter frequency are listed below.

- 250 Hz setting provides minimal noise filtering.
- 60 Hz setting provides 60 Hz AC line noise filtering.
- 50 Hz setting provides 50 Hz AC line noise filtering.
- 10 Hz setting provides both 50 Hz and 60 Hz AC line noise filtering.

When a CJC input type is selected, filter frequency is ignored. To maximize the speed versus resolution trade-off, CJC inputs are sampled at 60 Hz.

### Unused Bits (Bits 12 through 14)

Bits 12-14 are not defined. Ensure these bits are always cleared (0).

### Select Input Image Type (Bit 15)

The input image type bit allows you to select data or status information in the channel's input image word. When set (1), the module places channel data in the corresponding input image word. When the bit is cleared (0) the module places channel status in the corresponding input image word.

## Channel Data/Status Word

The actual thermocouple or millivolt input data values or channel status reside in I:e.0 through I:e.7 of the thermocouple module input image file. The data values present depend on the input type and data formats you have selected. When an input channel is disabled, its data word is reset (0).

### Module Input Image (Data/Status) Word

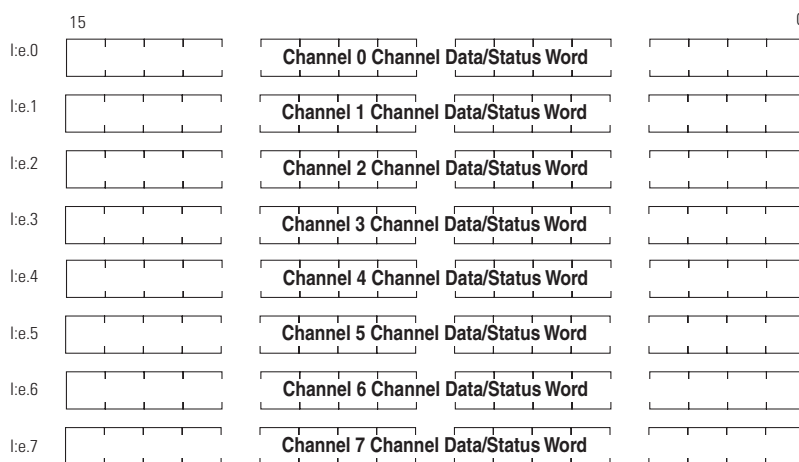

## Channel Status Checking

You can use the information provided in the status word to determine if the input configuration data for any channel is valid per your configuration in O:e.0 through O:e.7.

The channel status can be analyzed bit by bit. In addition to providing information about an enabled or disabled channel, each bit's status (0 or 1) tells you how the input data from the thermocouple or millivolt analog sensor connected to a specific channel will be translated for your application. The bit status also informs you of any error condition and can tell you what type of error occurred.

A bit-by-bit examination of the status word is provided in the chart on the following page.

**Channel 0 to 7 Status Word (I:e.0 through I:e.7) - Bit Definitions**

To Select		Make these bit settings																
		15	14	13	12	11	10	9	8	7	6	5	4	3	2	1	0	
<b>Channel</b>	<b>Channel Disable</b>																	0
<b>Status</b>	<b>Channel Enable</b>																	1
<b>Input Type</b>	<b>Thermocouple J</b>												0	0	0	0		
	<b>Thermocouple K</b>												0	0	0	1		
	<b>Thermocouple T</b>												0	0	1	0		
	<b>Thermocouple E</b>												0	0	1	1		
	<b>Thermocouple R</b>												0	1	0	0		
	<b>Thermocouple S</b>												0	1	0	1		
	<b>Thermocouple B</b>												0	1	1	0		
	<b>Thermocouple N</b>												0	1	1	1		
	<b>-50 to +50 mV</b>												1	0	0	0		
	<b>-100 to +100 mV</b>												1	0	0	1		
	<b>Invalid</b>												1	0	1	0		
	<b>Invalid</b>												1	0	1	1		
	<b>Invalid</b>												1	1	0	0		
	<b>Invalid</b>												1	1	0	1		
	<b>Invalid</b>												1	1	1	0		
<b>CJC temperature</b>												1	1	1	1			
<b>Data Format</b>	<b>Engineering Units x 1</b>											0	0					
	<b>Engineering Units x 10</b>											0	1					
	<b>Scaled-for-PID</b>											1	0					
	<b>Proportional counts</b>											1	1					
<b>Open Circuit</b>	<b>Zero on open circuit</b>											0	0					
	<b>Max. on open circuit</b>											0	1					
	<b>Min. on open circuit</b>											1	0					
	<b>Disabled</b>											1	1					
<b>Temperature units</b>	<b>°C</b>							0										
	<b>°F</b>							1										

**Channel 0 to 7 Status Word (I:e.0 through I:e.7) - Bit Definitions**

To Select		Make these bit settings															
		15	14	13	12	11	10	9	8	7	6	5	4	3	2	1	0
Channel filter frequency	10 Hz input filter					0	0										
	50 Hz input filter					0	1										
	60 HZ input filter					1	0										
	250 Hz input filter					1	1										
Open-circuit error	No error				0												
	Open circuit detected				1												
Under-range error	No error			0													
	Under range condition			1													
Over-range error	No error		0														
	Over range condition		1														
Channel error	No error	0															
	Channel error	1															

**TIP**

It takes one timing cycle to complete an update. (Refer to Chapter 3 for module update times.)

**IMPORTANT**

If the channel for which you are seeking status is disabled, all bit fields are cleared. The status word for any disabled channel is always 0000 0000 0000 0000 regardless of any previous setting that may have been made to the configuration word.

Explanations of the status conditions follow.

**Channel Status (Bit 0)**

The channel status bit indicates operational state of the channel. When the channel enable bit is set in the configuration word, the thermocouple module configures the selected channel and takes a data sample for the channel data word before setting this bit in the status word.

**Input Type Status (Bits 1 through 4)**

The input type bit field indicates what type of input signal you have configured for the channel. This field reflects the input type defined in the channel configuration word.

### **Data Format Type Status (Bits 5 and 6)**

The data format bit field indicates the data format you have defined for the channel. This field reflects the data type selected in bits 5 and 6 of the channel configuration word.

### **Open-Circuit Type Status (Bits 7 and 8)**

The open-circuit bit field indicates how you have defined the open-circuit bits configuration word, and therefore, the response of the thermocouple module to an open-circuit condition. This feature is active for all input types, including CJC temperature input.

### **Temperature Units Type Status (Bit 9)**

The temperature units field indicates the state of the temperature units bit in the configuration word (bit 9).

### **Channel Filter Frequency (Bits 10 and 11)**

The channel filter frequency bit field reflects the filter frequency you selected in the configuration word.

### **Open-Circuit E**

This bit is set (1) whenever a configured channel detects an open circuit condition at its input. An open-circuit at the CJC sensor also flags this error if the channel input type is either thermocouple or CJC temperature. A range error on the CJC sensor also flags this bit if the input type is thermocouple.

### **Under-Range Error (Bit 13)**

This bit is set (1) whenever a configured channel detects an under range condition for the channel data. An under-range condition exists when the input value is equal to or below the specified lower limit of the particular sensor connected to that channel.

### **Over-Range Error (Bit 14)**

This bit is set (1) whenever a configured channel detects an over range condition for the channel data. An over-range condition exists when the input value is equal to or above the specified upper limit of the particular sensor connected to that channel.

### **Channel Error (Bit 15)**

This bit is set (1) whenever a configured channel detects an error in the configuration word, or an error has occurred while acquiring the A/D data value. If during the auto-calibration process, the module detects an out-of-range condition for the filter frequency selected for the channel, the channel error bit is set. An out-of-range condition occurring during auto-calibration would be the result of an overly noisy environment, whereby the module cannot maintain accuracy specifications, thus flagging an error. The error bit is cleared when the error condition is resolved. The channel data word is not updated during a period of auto-calibration filter frequency tolerance errors.





## Programming Examples

Earlier chapters explained how the configuration word defines the way a channel operates. This chapter shows the programming required to configure the module. It also provides you with segments of ladder logic specific to unique situations that might apply to your programming requirements. The example segments include:

- basic example
- automatic monitoring thermocouples and CJC sensors
- verifying channel configuration changes
- interfacing to the PID instruction
- monitoring channel status bits
- PLC 5 example with NT8 in Remote I/O rack

To enter data into the channel configuration word (O:e.0 through O:e.7) when the channel is disabled (bit 0 = 0), follow these steps. Refer to the table on page 4-4 for specific configuration details.

**Example** - Configure eight channels of a thermocouple module residing in slot 3 of 1746 chassis. Configure each channel with the same parameters.

### Channel Configuration

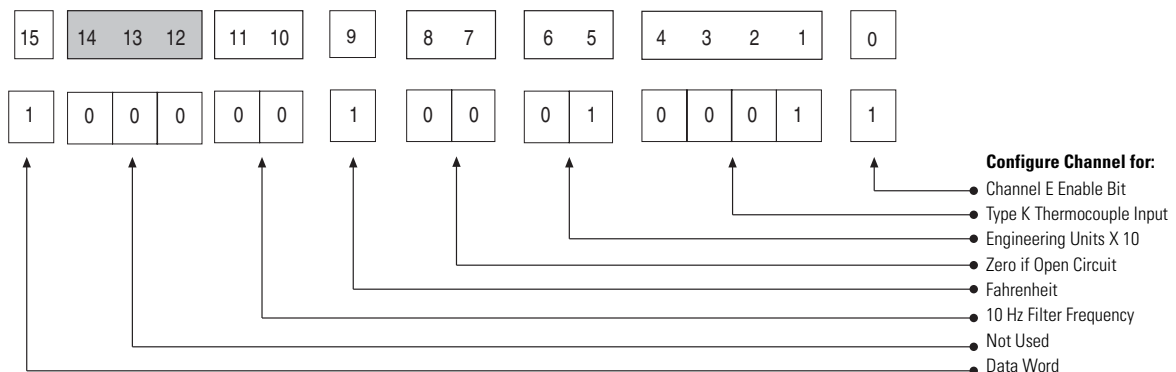

The following procedure transfers configuration data and sets the channel enable bits of all eight channels with a single File Copy instruction.

### Procedure

1. Create integer file N10. Integer file N10 should contain eight elements (N10:0 through N10:7).
2. Using the programming software, enter the configuration parameters for all eight thermocouple channels into data file locations N10:0 through N10:7.

#### Data table for initial programming

Data File N10 (bin) - NT 8 Configuration																		
Offset	15	14	13	12	11	10	9	8	7	6	5	4	3	2	1	0	Symbol	Description
N10:0	1	0	0	0	0	0	1	0	0	0	1	0	0	0	1	1		
N10:1	1	0	0	0	0	0	1	0	0	0	1	0	0	0	1	1		
N10:2	1	0	0	0	0	0	1	0	0	0	1	0	0	0	1	1		
N10:3	1	0	0	0	0	0	1	0	0	0	1	0	0	0	1	1		
N10:4	1	0	0	0	0	0	1	0	0	0	1	0	0	0	1	1		
N10:5	1	0	0	0	0	0	1	0	0	0	1	0	0	0	1	1		
N10:6	1	0	0	0	0	0	1	0	0	0	1	0	0	0	1	1		
N10:7	1	0	0	0	0	0	1	0	0	0	1	0	0	0	1	1		

3. Program a rung in your ladder logic to copy the contents of integer file N10 to the eight consecutive output words of the thermocouple module beginning with O:3.0.

#### Initial programming example

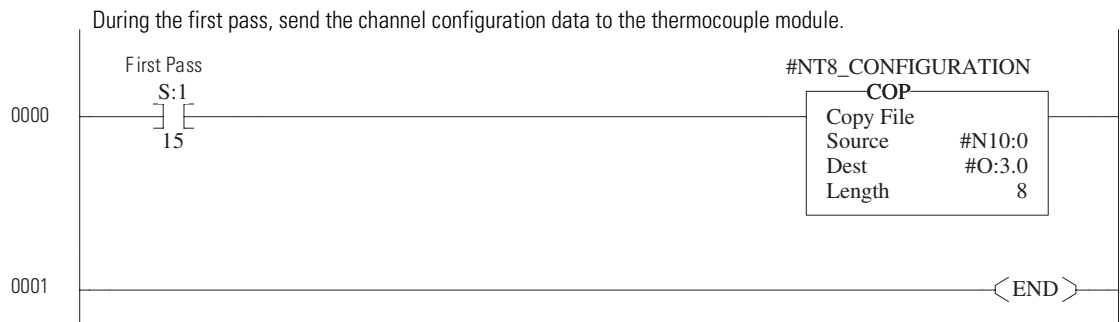

On power up, bit S:1/15 is set for the first program scan. During the first program scan, the configuration data in N10:0 through N10:7 will be sent to the 1746-NT8 channel configuration words.

## Automatic Monitoring Thermocouples and CJC Sensors

The following example explains how to change data in the channel configuration word when the channel is currently enabled.

**Example** - Execute a dynamic configuration change to channel 0 of the thermocouple module located in slot 1 of a 1746 chassis. Periodically (e.g., every 60 seconds) change from monitoring an external type K thermocouple to monitoring the CJC sensors mounted on the terminal block. The CJC reading gives a good indication of what the temperature is inside the control cabinet. Finally, set channel 0 back to type K thermocouple.

---

**IMPORTANT**

During configuration alteration, the state of each modified channel can not be determined until after one module update time.

---

**TIP**

N10:2/1 through N10:2/4 have the input type for type K Thermocouple (0001). N10:8/1 through N10:8/4 have the input type for CJC Temperature Sensor (1111).

## Verifying Configuration Changes

When executing a dynamic channel configuration change, there is always a delay from the time the ladder program makes the change to the time the 1746-NT8 supplies a data word using that new configuration information. Also, the ladder program should use the thermocouple temperature data location N10:20 for thermocouple temperature readings and data location N10:12 for CJC temperature readings.

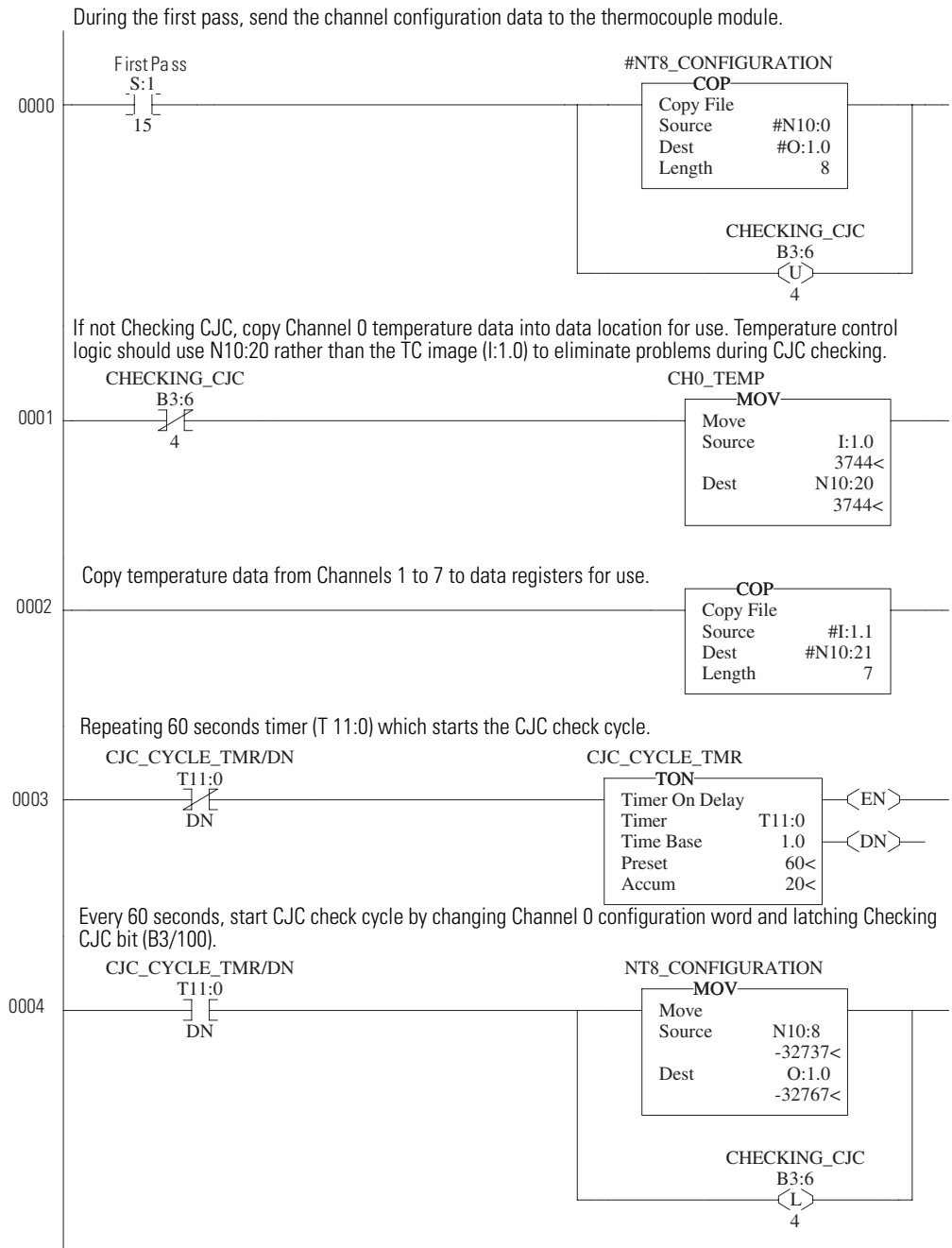

Wait 7 seconds for Channel 0 to accept CJC configuration and provide a data value (time depends on module configuration).

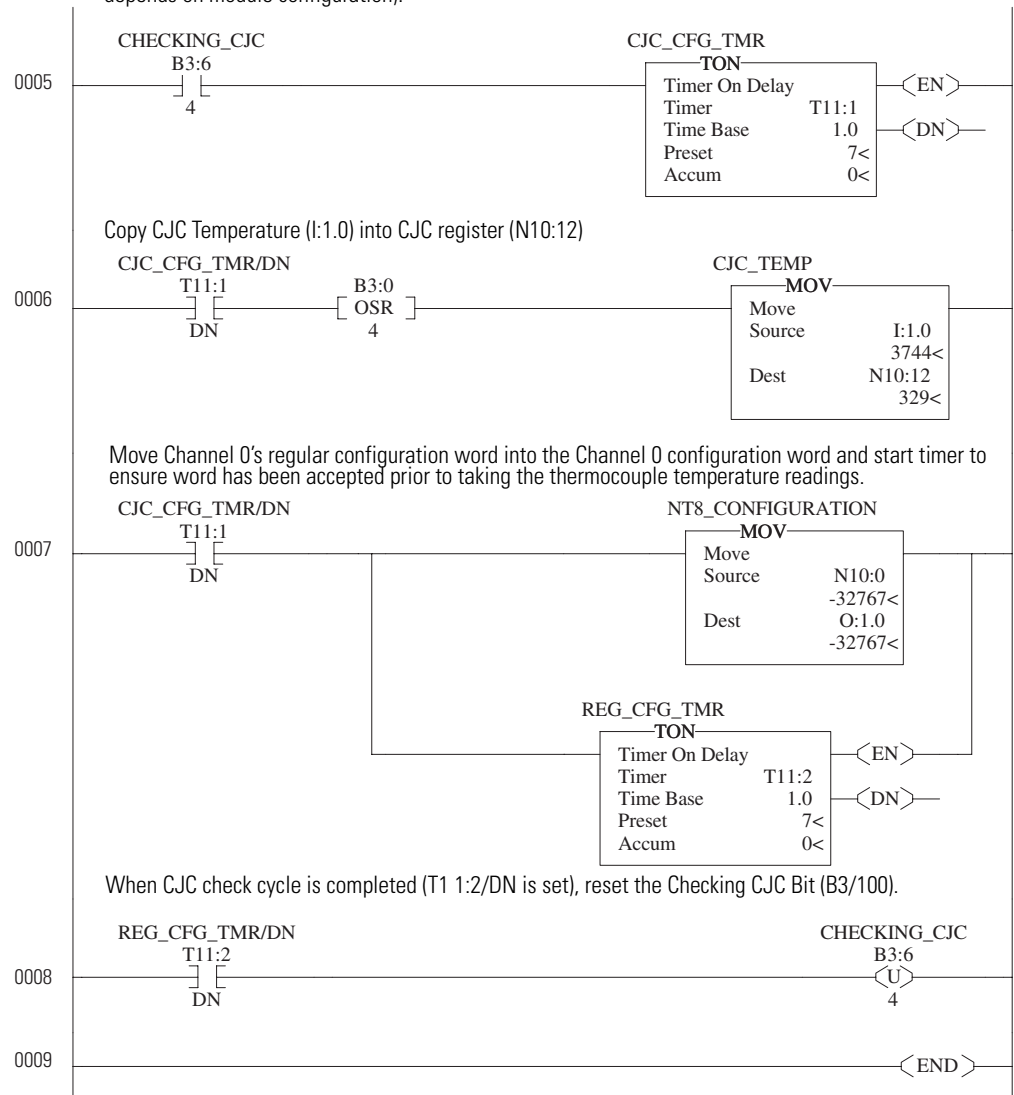

**Data Table for Configuration Changes**

address	15	data			0	address	15	data			0
N10:0	0000	0010	0010	0011	0011	N10:8	0000	0010	0011	1111	1111
N10:1	0000	0010	0010	0011	0011						
N10:2	0000	0010	0010	0011	0011						
N10:3	0000	0010	0010	0011	0011						
N10:4	0000	0010	0010	0011	0011						
N10:5	0000	0010	0010	0011	0011						
N10:6	0000	0010	0010	0011	0011						
N10:7	0000	0010	0010	0011	0011						

**Update Time Calculation**

Ch 0 Update Time	0.470
Ch 0 Open Circuit Check	0.045
Ch 1 Update Time	0.470
Ch 1 Open Circuit Check	0.045
Ch 2 Update Time	0.470
Ch 3 Update Time	0.470
Ch 3 Open Circuit Check	0.045
Ch 4 Update Time	0.470
Ch 4 Open Circuit Check	0.045
Ch 5 Update Time	0.470
Ch 6 Update Time	0.470
Ch 6 Open Circuit Check	0.045
Ch 7 Update Time	0.470
Ch 7 Open Circuit Check	0.045
CJC Checking	0.290
Update Time	4.410

**Auto-calibration Time Calculation**

Auto-calibration for 10 Hz	1.975
Auto-calibration for 60 Hz	0.525
Total Auto-calibration	2.500
Max Time Between Updates	6.910

After a channel configuration word is changed by the ladder logic, the module may not update the processor's input image until one update time later. In order to ensure that the program is using the proper input data, the ladder logic should wait one update time plus one

calibration time to ensure that the new input data matches the channel configuration requested. The above table shows how to calculate the update time and auto-calibration time for the channel configuration being used.

## Interfacing to the PID Instruction

The thermocouple module was designed to interface directly to the SLC 5/02 or later processor PID instruction without the need for an intermediate scale operation.

**Example** - Use 1746-NT8 channel data as the process variable in the PID instruction.

1. Select scaled-for-PID as the data type in the channel configuration word.
2. Specify the thermocouple channel data word as the process variable for the PID instruction.

In this example, the value -32701 (8043 H) is the numeric equivalent of configuration word N10:0 for channel 0. It is configured for a type K thermocouple, scaled-for-PID, zero the signal for an open-circuit, 10 Hz, °C, and channel enabled.

### Programming for PID Control Example

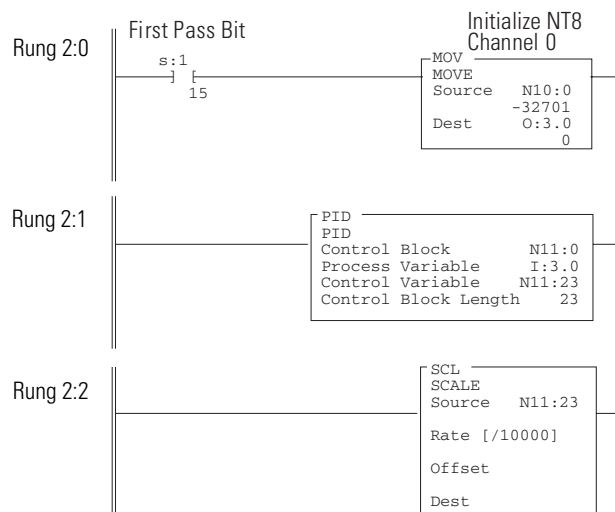

The Rate and Offset parameters should be set per your application. The Destination will typically be an analog output channel.

## Monitoring Channel Status Bits

The following example shows how to monitor the open-circuit error bits of each channel and set an alarm in the processor if one of the thermocouples opens. An open-circuit error can occur if the thermocouple breaks, one of the thermocouple wires gets cut or disconnected from the terminal block, or if the CJC sensors are not installed or are damaged.

---

**IMPORTANT**

If a CJC input is not installed or is damaged, all enabled thermocouple alarms are set, and all enabled thermocouple

---

The example shows how to automatically switch between reading the channel status words and channel sensor data words. Specifically, this example shows a simple method of utilizing a timer to periodically switch between reading the channel status and data words.

The program utilizes a timer accumulator value to determine when to set up the configuration words and when to read in the channel status and channel data information. The channel status information is copied from the I:2.0 to I:2.7 registers into registers N7:10 to N7:17. The channel data information is copied from I:2.0 to I:2.7 into registers N7:0 to N7:7. This allows sensor data and channel status information to be accessed at any time from these registers. However, when the module channels are configured to read sensor data, the channel status words (as reflected in N7:10 to N7:17) are not being dynamically updated, and vice-versa.



### Monitoring Channel Status Bits Example

During 1st program scan, copy thermocouple channel configuration words (N10:0 - N10:7) to NT8. In addition, initialize channel error registers (N10:20 - N10:27) and Error Flags (B3/119).

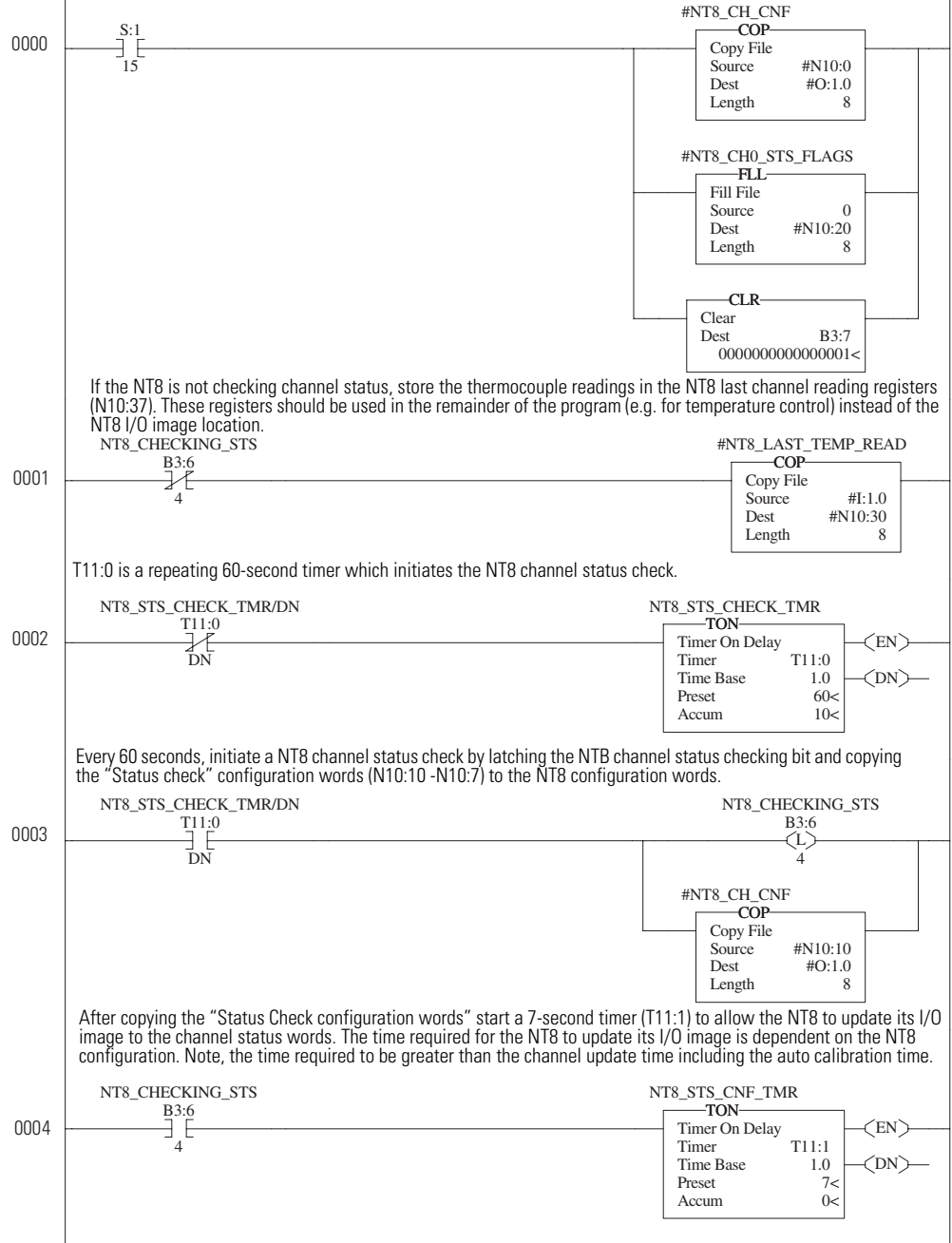

After waiting for the NT8 to update its I/O image, check each channel's status error bits by masking off the appropriate bits and checking if these bits are set (non-zero). If an error is detected, set the appropriate channel status error bits (B3:112 - B3:119). Rung 5 checks channels 0 to 3).

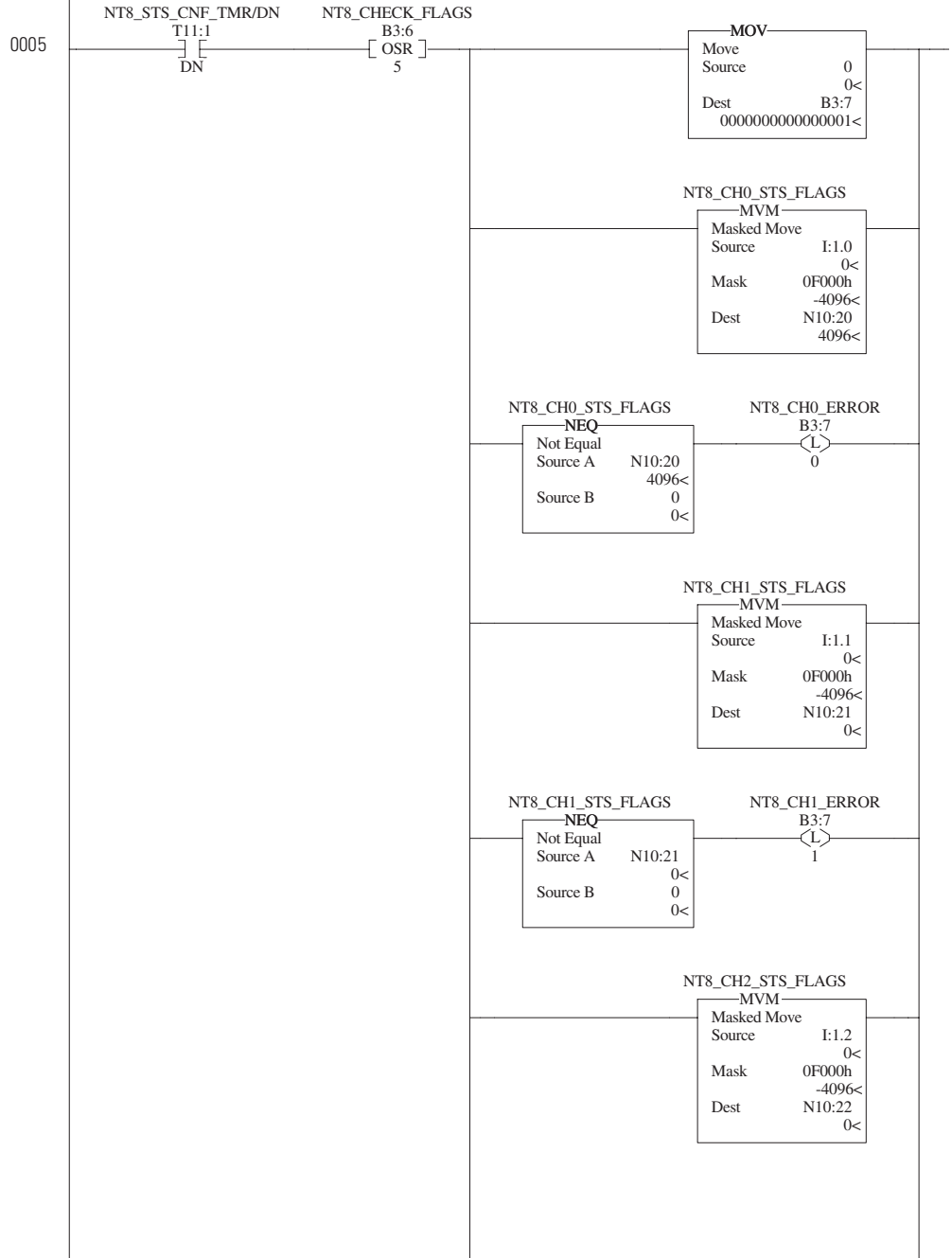

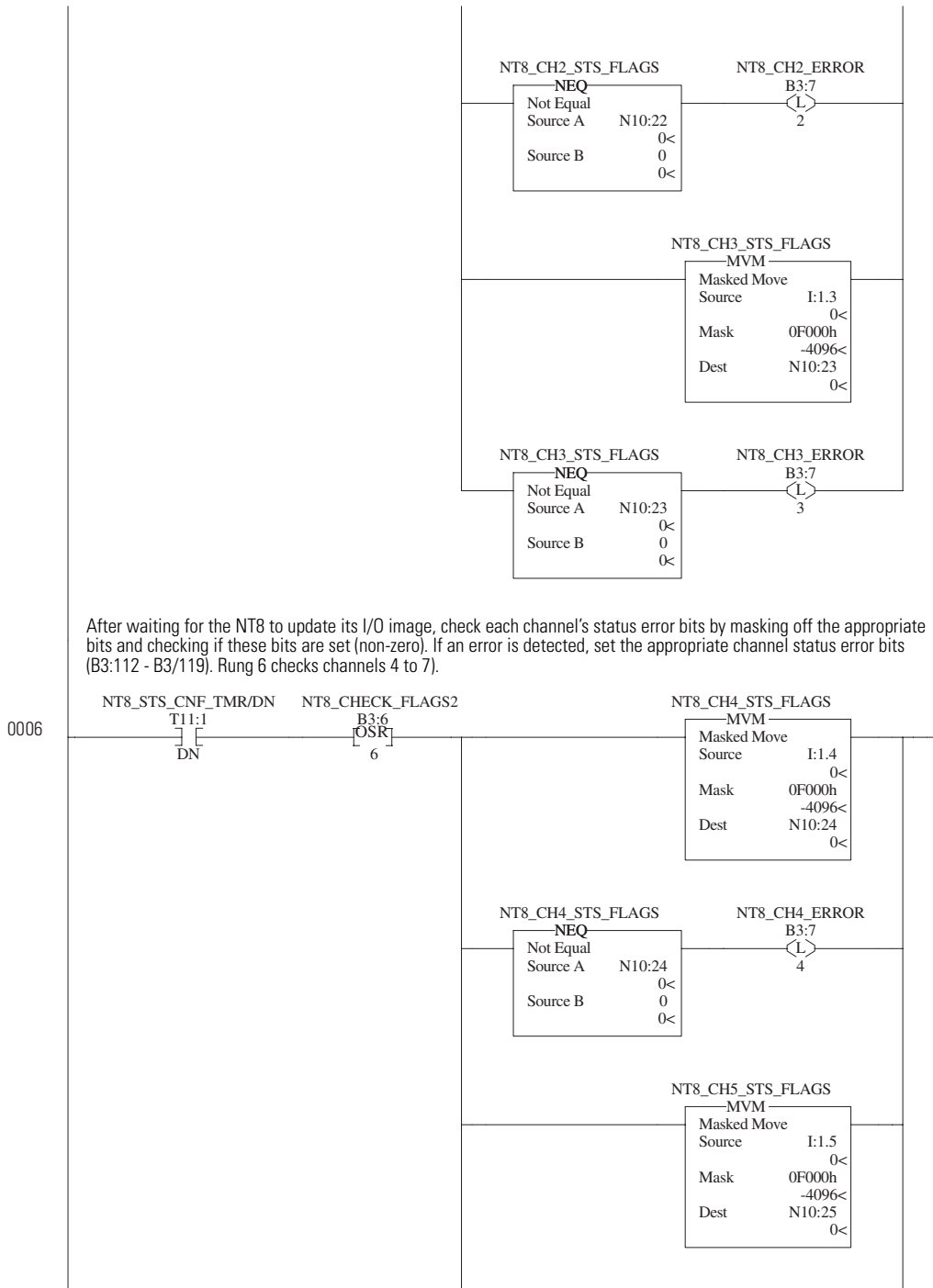

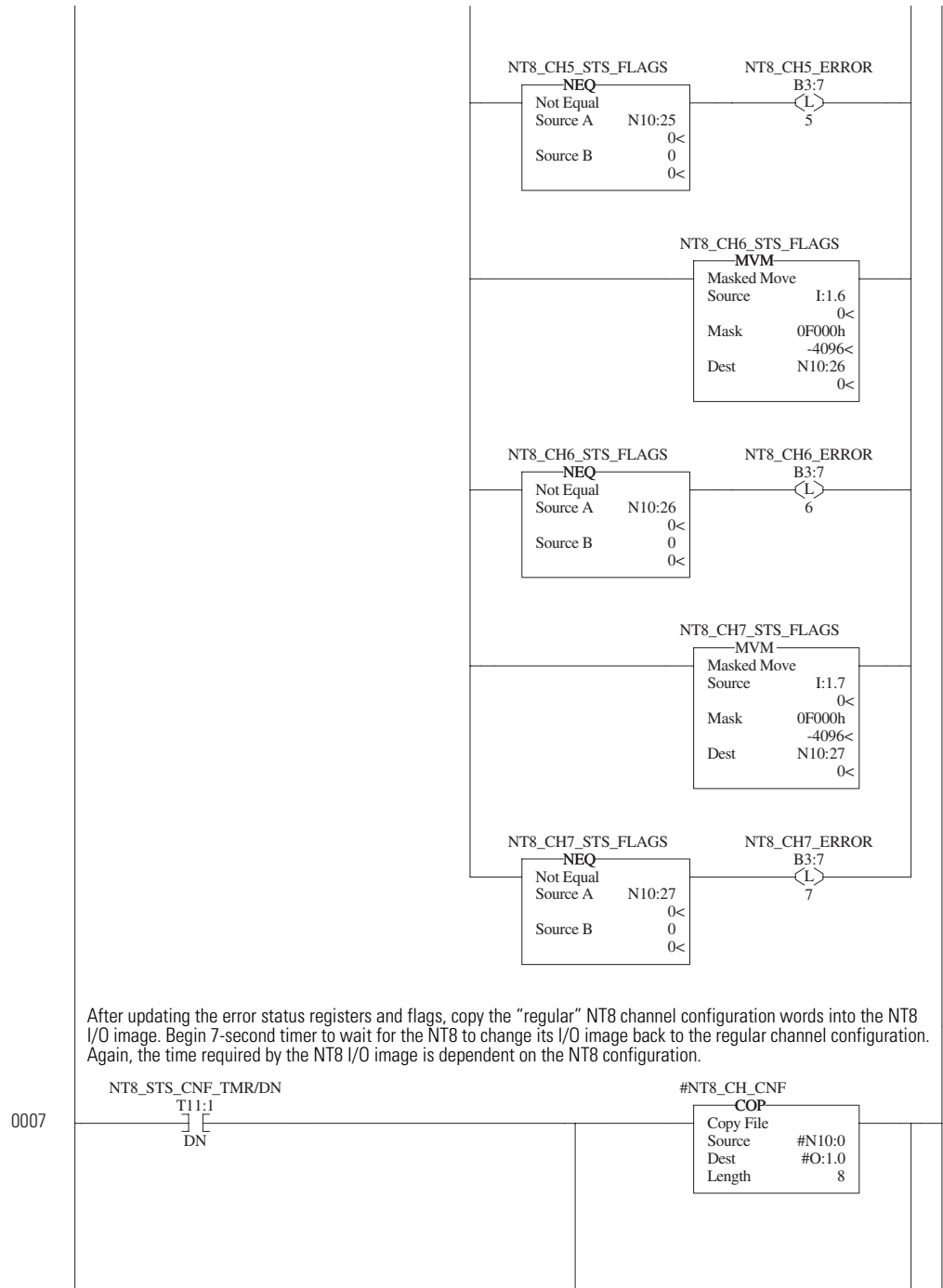

After updating the error status registers and flags, copy the "regular" NT8 channel configuration words into the NT8 I/O image. Begin 7-second timer to wait for the NT8 to change its I/O image back to the regular channel configuration. Again, the time required by the NT8 I/O image is dependent on the NT8 configuration.



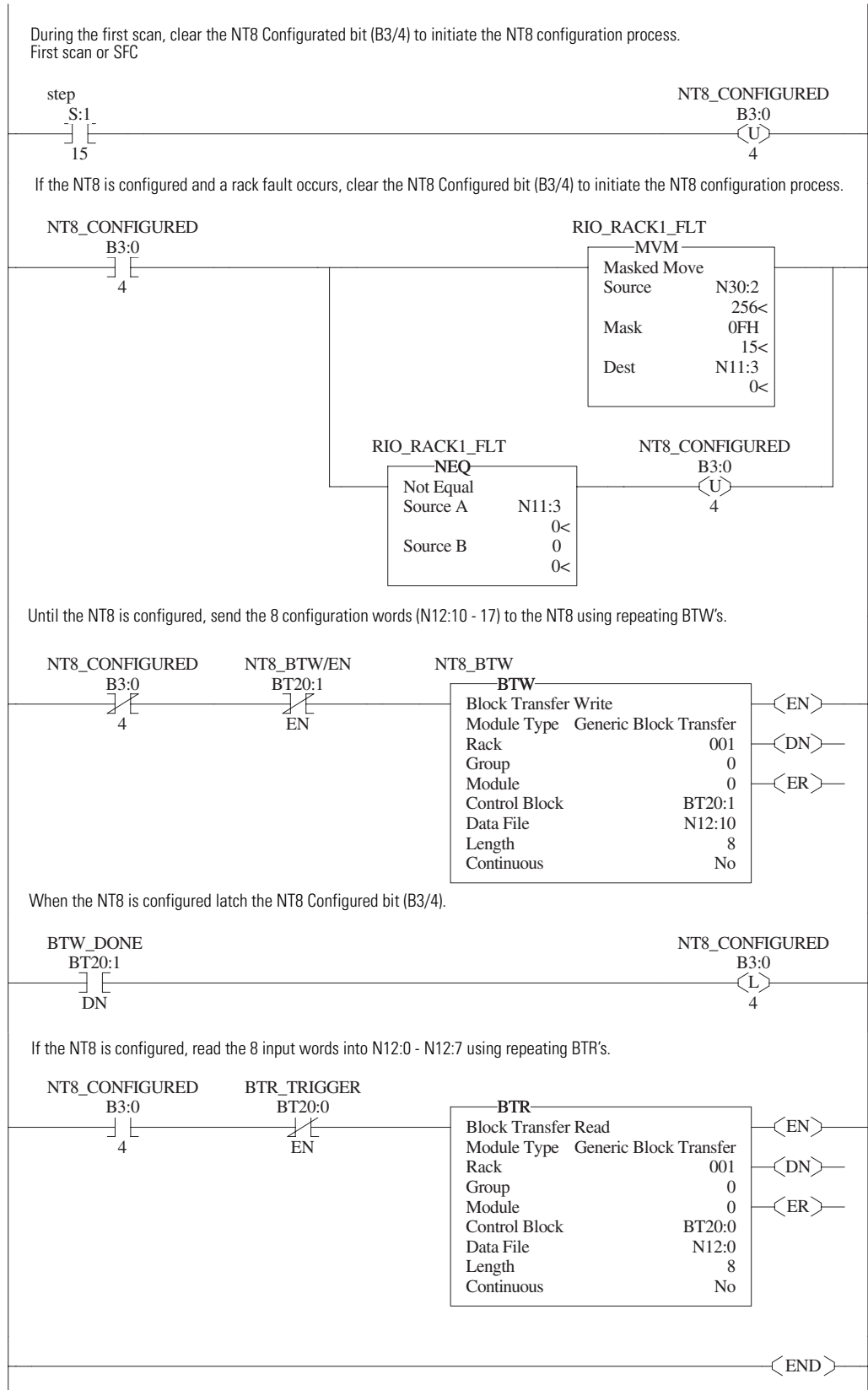

## SLC 500 Example with NT8 in Remote I/O Rack

The following example shows sample ladder logic when using an SLC controller to control the module in remote rack across the Remote I/O network. The SLC must use Block transfer reads and writes to communicate with the 1746-NT8 module in a remote rack.

### RIO example with SLC processor

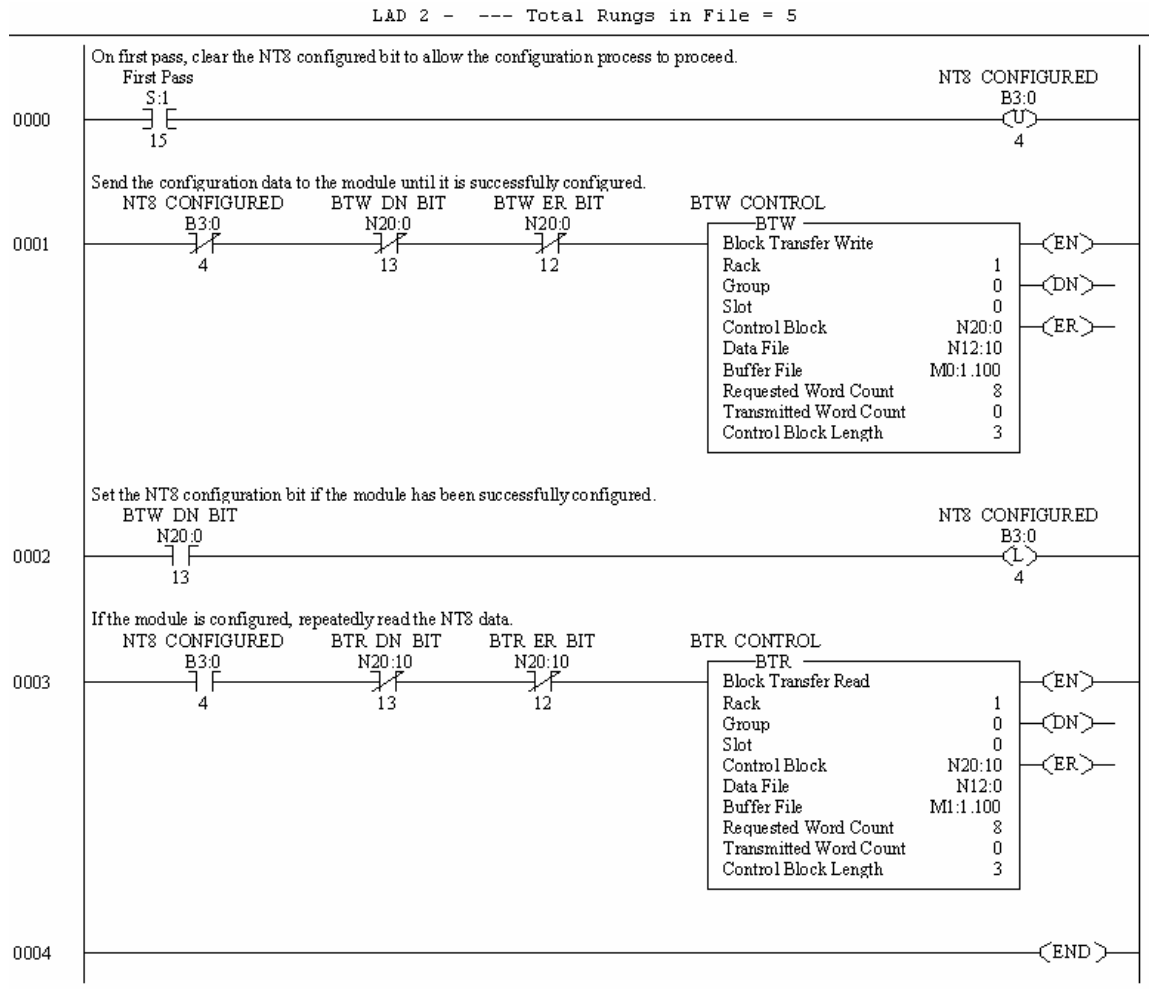

SLC processors with a 1747-SN series B RIO Scanner can use the block transfer instructions similarly to the PLC/5. This ladder example shows this implementation. The data file elements N20:10- N20:17 contain the configuration data for the NT8 as defined in previous examples.





## Troubleshooting Your Module

This chapter describes troubleshooting with channel-status and module-status LEDs. It explains the types of conditions that might cause the module to flag an error and suggests what corrective action you could take. Topics include:

- module and channel diagnostics
- LED indicators
- interpreting I/O error codes
- troubleshooting flowchart

### Module and Channel Diagnostics

The module operates at two levels:

- module level
- channel level

Module-level operation includes functions such as powerup, configuration, and communication with the SLC processor. Channel level operation includes functions such as data conversion and open circuit detection. The module performs internal diagnostics at both levels and immediately indicates detected error conditions with either of its status LEDs. See the LED troubleshooting tables on page 6-3 for LED operation.

### Module Diagnostics at Powerup

At module powerup, the module performs a series of internal diagnostic tests. If the module detects a failure, the module status LED remains off.

### Channel Diagnostics

When a channel is enabled, the module checks for a valid configuration. Then on each scan of its inputs, the module checks for out-of-range and open-circuit fault conditions of its inputs including the CJC input.

When the module detects a failure of any channel diagnostic test, it causes the channel status LED to blink and sets the corresponding

channel fault bit (bits 12-15 of the channel status word). Channel fault bits and LEDs are self-clearing when fault conditions are corrected.

---

**IMPORTANT**

If you clear the channel enable bit, the channel status bits are reset.

---

The module has nine LEDs; as shown below.

- eight channel-status LEDs, numbered to correspond with each channel
- one module-status LED

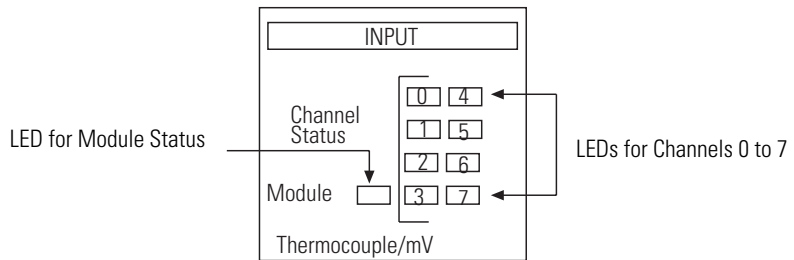

## LED Troubleshooting Tables

### Module-status LED

<b>If Module Status LED is:</b>	<b>Then:</b>	<b>Take this Corrective Action:</b>
On	The module is operating properly.	No action required.
Off	The module is turned off, or it detected a module fault.	Cycle power. If the condition persists, call your local Allen-Bradley distributor for assistance.
Flashing	Jumper may be in wrong position.	Check jumper 1 position.

### Module-status and Channel-status LED

<b>If Module Status LED is:</b>	<b>And Channel Status LED is:</b>	<b>Then:</b>	<b>Take this Corrective Action:</b>
On	On	The channel is enabled.	No action required.
	Flashing	The module detected: open-circuit condition, under-range condition, over-range condition.	Examine error bits in status word If bit 12=1, the input has an open circuit If bit 13=1, the input value is under range If bit 14=1, the input value is over range If bit 15=1, the channel has a diagnostic channel error
	Off	The module is in power up, or the channel is disabled.	No action is required.

## Channel-status LEDs (Green)

The channel-status LED operates with status bits in the channel status word to indicate the following faults detected by the module:

- invalid channel configuration
- an open-circuit input
- out-of-range errors
- selected filter frequency data acquisition or auto-calibration errors

When the module detects any of the following fault conditions, it causes the channel-status LED to flash and sets the corresponding fault bit in the channel status word. Channel fault bits (bits 12 through 15) and channel-status LEDs are self-clearing when fault conditions are corrected.

## Open-circuit Detection (Bit 12)

If open-circuit detection is enabled for an input channel, the module tests the channel for an open-circuit condition each time it scans its input. Open-circuit detection is always performed for the CJC inputs. Possible causes of an open circuit include:

- broken thermocouple or CJC sensor
- thermocouple or CJC sensor wire cut or disconnected
- millivolt input wire cut or disconnected

## Out-of-Range Detection (Bit 13 for Under Range, Bit 14 for Over Range)

The module tests all enabled channels for an out-of-range condition each time it scans its inputs. Possible causes of an out-of-range condition include:

- the temperature is too hot or too cold for the thermocouple being used.
- a type B thermocouple may be registering a °F value in Engineering Units x1 beyond the range allowed by the SLC processor (beyond 32,767) for the data word.
- a CJC sensor may be damaged or the temperature being detected by the CJC may be outside the CJC sensor range limits.

## Channel Error (Bit 15)

The module sets this fault bit when it detects any of the following configuration errors:

- configuration bits 1 through 4: invalid input type = 1010, 1011, 1100, 1101, or 1110.
- configuration bits 12 through 14: invalid non-zero bit setting.
- invalid data acquisition of an input channel.
- the filter frequency selected for the valid channel currently fails auto-calibration range checks.

## Module Status LED (Green)

The module-status LED indicates when the module detects a non-recoverable fault at power up or during operation. For this type of fault, the module:

- no longer communicates with the SLC processor
- disables all channels
- clears all data and status words

A module failure is non-recoverable and requires the assistance of your local Allen-Bradley distributor.

## Interpreting I/O Error Codes

I/O error codes appear in word S:6 of the SLC processor status file. The first two digits of the error code identify the slot (in hexadecimal) with the error. The last two digits identify the I/O error code (in hexadecimal).

The error codes that apply to your module include (in hexadecimal):

- 50 through 5E
- 71 (watchdog error)
- 90 through 94

For a description of the error codes, refer to the *SLC 500 Instruction Set Reference Manual*, publication 1746-RM001.

### Troubleshooting Flowchart

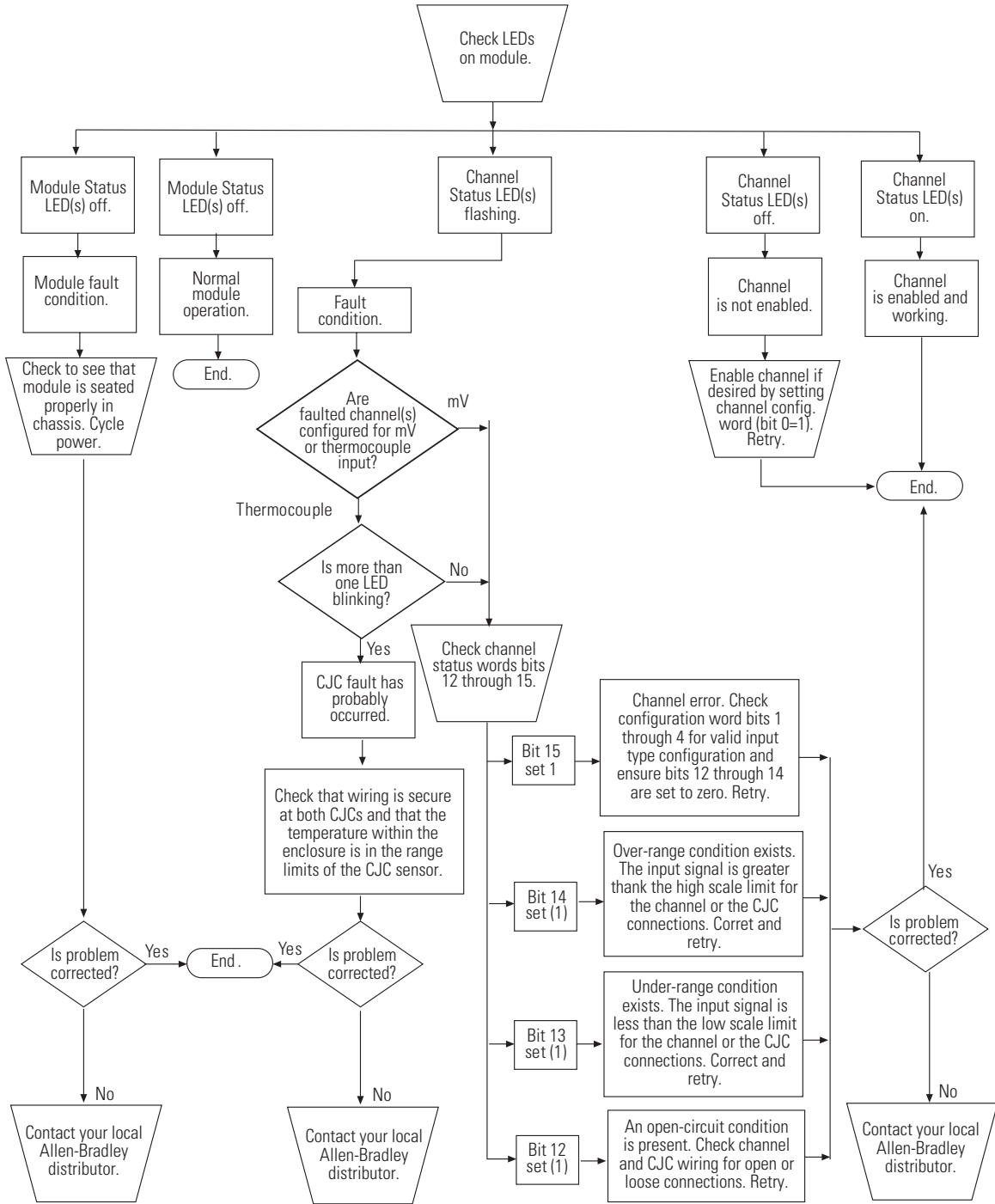

---

## Maintaining Your Module And Safety Considerations

Read this chapter to familiarize yourself with:

- preventive maintenance
- safety considerations

The National Fire Protection Association (NFPA) recommends maintenance procedures for electrical equipment. Refer to article 70B of the NFPA for general safety-related work practices.

### Preventive Maintenance

The printed circuit boards of your module must be protected from dirt, oil, moisture, and other airborne contaminants. To protect these boards, install the SLC 500 system in an enclosure suitable for its operating environment. Keep the interior of the enclosure clean, and whenever possible, keep the enclosure door closed.

Also, regularly inspect the terminal connections for tightness. Loose connections may cause a malfunction of the SLC system or damage to the components.

---

**ATTENTION****Possible Loose Connections**

Before inspecting connections, always ensure that incoming power is OFF.

Failure to observe this precaution can cause personal injury and equipment damage.

---

### Safety Considerations

Safety is always the most important consideration. Actively think about the safety of yourself and others, as well as the condition of your equipment. Consider the following:

**Indicator Lights** – When the module status LED on your module is illuminated, your module is receiving power.

**Activate Devices When Troubleshooting** – Never reach into a machine to activate a device; the machine may move unexpectedly. Use a wooden stick.

**Stand Clear Of Machinery** – When troubleshooting a problem with any SLC 500 system, have all personnel remain clear of machinery. The problem may be intermittent, and the machine may move unexpectedly. Have someone ready to operate an emergency stop switch.

---

**ATTENTION**



**Possible Equipment Operation**

Never reach into a machine to actuate a switch. Also, remove all electrical power at the main power disconnect switches before checking electrical connections or inputs/outputs causing machine motion.

Failure to observe these precautions can cause personal injury or equipment damage.

---

**Safety Circuits** – Circuits installed on machinery for safety reasons (like over-travel limit switches, stop push-buttons, and interlocks) should always be hard-wired to the master control relay. These circuits should also be wired in series so that when any one circuit opens, the master control relay is de-energized, thereby removing power.

**Class 1, Division 2** - This equipment is suitable for use in Class 1, Division 2, groups A, B, C, and D or non-hazardous locations only.

---

**ATTENTION**



**Explosion Hazard**

Never modify these circuits to defeat their function. Serious injury or equipment damage may result.

- Substitution of components may impair suitability for Class 1 Division 2.
  - Do not disconnect equipment unless power has been switched off or the area is known to be nonhazardous.
  - When in hazardous locations, turn off power before replacing or wiring modules.
- 

Refer to your system's *User Manual* for more information.



## Module Specifications

This appendix lists the specifications for the 1746-NT8 Thermocouple/millivolt Input Module.

### Electrical Specifications

Backplane Current Consumption	120 mA at 5V dc 70 mA at 24Vdc
Backplane Power Consumption	2.28W maximum (0.6W at 5V dc, 1.68W at 24V dc)
Number of Channels	8 (backplane and channel-to-channel isolated)
I/O Chassis Location	Any I/O module slot except 0
A/D Conversion Method	Sigma-Delta Modulation
Input Filtering	Input Filtering Low pass digital filter with programmable notch (filter) frequencies
Normal Mode Rejection (between [+] input and [-] input)	Greater than 100 dB at 50/60 Hz
Common Mode Rejection (between input and ground)	Greater than 100 dB at 50/60 Hz
Input Filter Cut-Off Frequencies <ul style="list-style-type: none"> <li>• 2.6 Hz at 10 Hz filter frequency</li> <li>• 13.1 Hz at 50 Hz filter frequency</li> <li>• 15.72 Hz at 60 Hz filter frequency</li> <li>• 65.5 Hz at 250 Hz filter frequency</li> </ul>	Greater than 100 dB at 50/60 Hz
Calibration	Module autocalibrates at power-up and approximately every two minutes afterward
Input Over-voltage Protection	±30V dc continuous 600W pulsed for 1 ms.
Isolation	500V dc for 1 minute between inputs and chassis ground and between inputs and backplane. 12.5V dc continuous between channels.

## Physical Specifications

LED Indicators	9 green status indicators, one for each of 8 channels and one for module status
Module ID Code	3533
Recommended Cable: for thermocouple inputs...	Appropriate shielded twisted pair thermocouple extension wire <sup>(1)</sup>
for mV inputs...	Belden™ 8761 or equivalent
Maximum Wire Size	One 14 AWG wire or two 22 AWG wires per terminal

(1) Refer to the thermocouple manufacturer for the correct extension wire.

## Environmental Specifications

Operating Temperature	0°C to +60°C (+32°F to +140°F)
Storage Temperature	-40°C to +85°C (-40°F to +185°F)
Relative Humidity	5% to 95% (without condensation)
Certification	UL and CUL approved
Hazardous Environment Classification	Class I Division 2 Hazardous Environment Groups A, B, C, D
EMC	CE compliant for all applicable directives C-Tick compliant for all applicable acts

## Input Specifications

Type of Input (Selectable)	Thermocouple Type J	-210°C to +760°C	(-346°F to +1400°F)
	Thermocouple Type K	-270°C to +1370°C	(-454°F to +2498°F)
	Thermocouple Type T	-270°C to +400°C	(-454°F to +752°F)
	Thermocouple Type E	-270°C to +1000°C	(-454°F to +1832°F)
	Thermocouple Type R	0°C to +1768°C	(+32°F to +3214°F)
	Thermocouple Type S	0°C to +1768°C	(+32°F to +3214°F)
	Thermocouple Type B	+300°C to +1820°C	(+572°F to +3308°F)
	Thermocouple Type N	0°C to +1300°C	(+32°F to +2372°F)
	Millivolt (-50mV dc to +50mV dc)		
	Millivolt (-100mV dc to +100mV dc)		
Thermocouple Linearization	NIST ITS-90 standard		
Cold Junction Compensation	Accuracy $\pm 1.72^{\circ}\text{C}$ , $-25^{\circ}\text{C}$ to $+105^{\circ}\text{C}$		
Module Input Impedance	Greater than 10MW		
Input Device Impedance	Output impedance of input device must be less than 100 ohm to meet accuracy specifications.		
Temperature Scale (Selectable)	$^{\circ}\text{C}$ or $^{\circ}\text{F}$ and $0.1^{\circ}\text{C}$ or $0.1^{\circ}\text{F}$		
DC Millivolt Scale (Selectable)	0.1 mV or 0.01 mV		
Open Circuit Detection (Selectable)	Upscale, Downscale, Zero, or Disabled		
Time to Detect Open Circuit	One channel cycle time		
Input Step Response	0 to 95% in 400 ms (10 Hz)		
Display Resolution	See Channel Data Word Resolution table on page 4-8		
Overall Module Accuracy at $257^{\circ}\text{C}$ ( $77^{\circ}\text{F}$ )	See Module Accuracy Tables, page A-6		
Overall Module Accuracy	See Module Accuracy Tables, page A-6		
Overall Module Drift	See Module Accuracy Tables, page A-6		
Module Update Time	Dependent upon enabled channels (see Update Time, page 3-7)		
Channel Turn-Off Time	Up to one module update time		

## Overall Accuracy

The accuracy of the module is determined by many aspects of the hardware and software functionality of the module. The following discussion explains what the user can expect in terms of accuracy based on the thermocouple and millivolt inputs for the 1746-NT8 module.

The accuracies specified as follows include errors due to the cold junction compensation for thermocouples and hardware and software errors associated with the system. The hardware and software errors include calibration of the system and non-linearity of the ADC. For the sake of the calculations, the resolution of the ADC was assumed to be at least 16 bits (use of the 10 Hz, 50 Hz, and 60 Hz filter frequencies).

**TIP**

The 250 Hz frequency should not be applied to thermocouple inputs (See table on page 3-4).

## Millivolt

For millivolt inputs, the error is  $\pm 30$  uV typical at 25°C, and  $\pm 120$  uV maximum over temperature for the 10 Hz, 50 Hz, and 60 Hz filter frequencies. The 250 Hz filter frequency accuracy is highly dependent upon operating environment and may be worse in noisy environments.

As with any high precision analog input device, system grounding does affect the accuracy of the readings. Care should be taken to ensure that the proper filter frequency has been selected based on the environmental conditions in which the module is to be used.

CJC compensation does not affect the millivolt inputs in terms of accuracy.

The following diagrams are provided to give a measure of “system” accuracy using test data from a single test module. The tests recorded deviation between measured and expected values. This data was taken over an entire range of the thermocouple (or millivolt range, as applicable) and over the module’s temperature range (0 - 60°C). The maximum deviation for each thermocouple temperature (or millivolt range) was plotted.

**uV Err, ±100mV Span, Prop Cts, 60 Hz, 0°C**

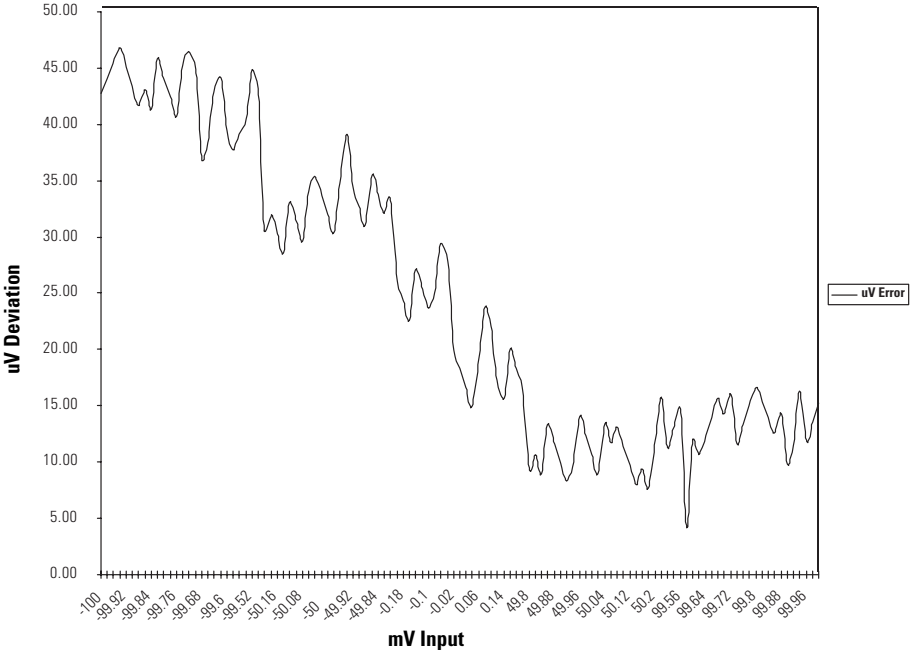

**uV Err, ±100mV Span, Prop Cts, 60 Hz, 25°C**

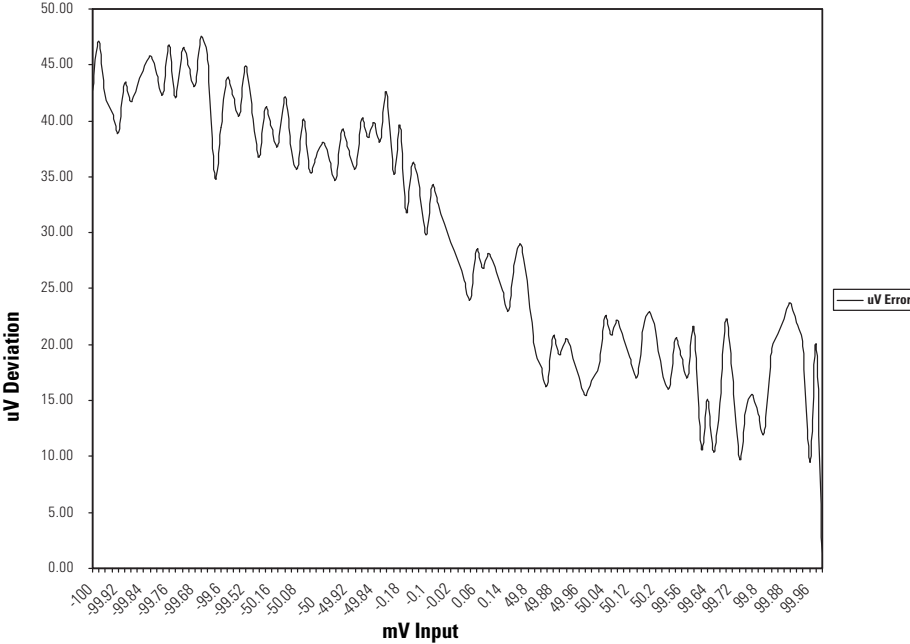

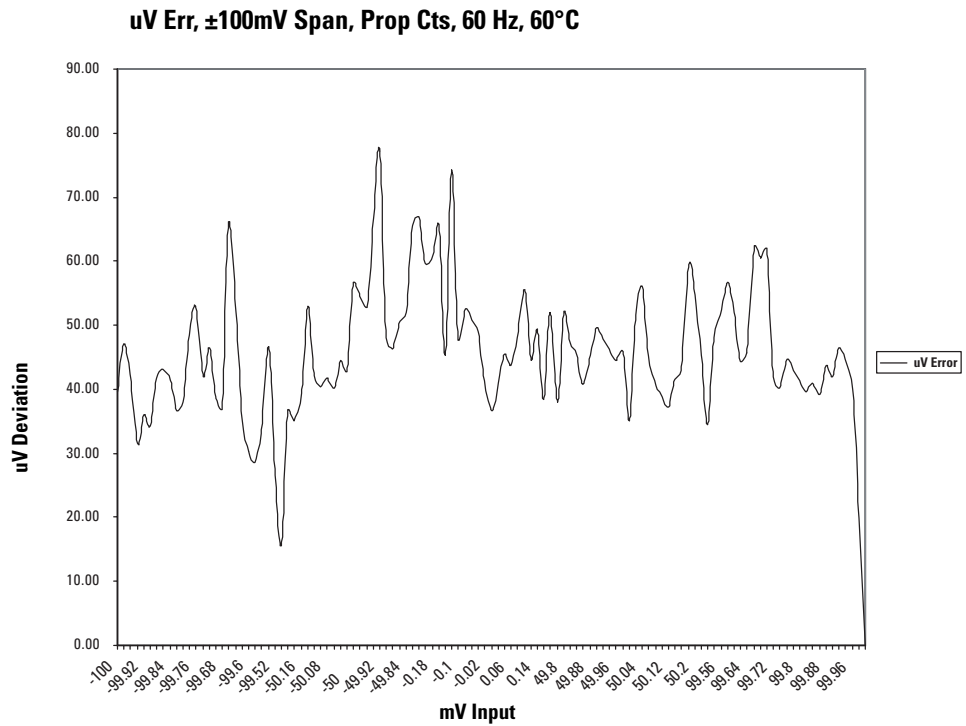

### Thermocouple

The following table provides the total error expected of the thermocouple based on the thermocouple type, and the given reference point, at 25°C. The calculations assumed typical hardware/software error and typical CJC accuracy at 25°C.

Thermocouple Type	Thermocouple Reference Point	Error
J	+275°C (+527°F)	±1.4°C (±2.52°F)
K	+550°C (+1022°F)	±1.5°C (±2.7°F)
T	+65°C (+149°F)	±1.3°C (±2.34°F)
E	+365°C (+689°F)	±1.3°C (±2.34°F)
R	+885°C (+1625°F)	±3.6°C (±6.48°F)
S	+885°C (+1625°F)	±3.4°C (±6.12°F)
B	+1060°C (+1940°F)	±2.7°C (±4.86°F)
N	+500°C (+932°F)	±1.3°C (±2.34°F)

The following table provides the total error expected over the temperature range of the module (0 to 60°C) for each thermocouple based upon the type, and the given reference point, at the extremes of the temperature range (0 or 60°C). The calculations are based on maximum hardware/software error and maximum CJC inaccuracy over temperature.

Thermocouple Type	Thermocouple Reference Point	Error
J	+275°C (+527°F)	±3.0°C (±5.4°F)
K	+550°C (+1022°F)	±3.0°C (±5.4°F)
T	+65°C (+149°F)	±3.4°C (±6.12°F)
E	+365°C (+689°F)	±2.5°C (±4.5°F)
R	+885°C (+1625°F)	±6.5°C (±11.7°F)
S	+885°C (+1625°F)	±7.2°C (±12.96°F)
B	+1060°C (+1940°F)	±8.4°C (±15.12°F)
N	+500°C (+932°F)	±3.0°C (±5.4°F)

The diagrams that follow for each thermocouple type give data for a sample module over the input range of the thermocouple over temperature. Thermocouples are usually parabolic in their  $\mu\text{V}$  to  $^{\circ}\text{C}$  curves. Normally, at the ends of any given thermocouple range, the ratio of change in temperature increases as a result of a change in voltage. In other words, at the ends, a smaller change in voltage results in a larger change in  $^{\circ}\text{C}$ . The data that follows gives an idea of a sample module's error over the thermocouple range, versus at a single reference point as provided with the tables above.

**TIP**

The data was recorded at 60 Hz. Values at 10 Hz and 50 Hz would be comparable.

**uV Err, ±100mV Span, Prop Cts, 60 Hz, 0°C, 25°C, 60°C**

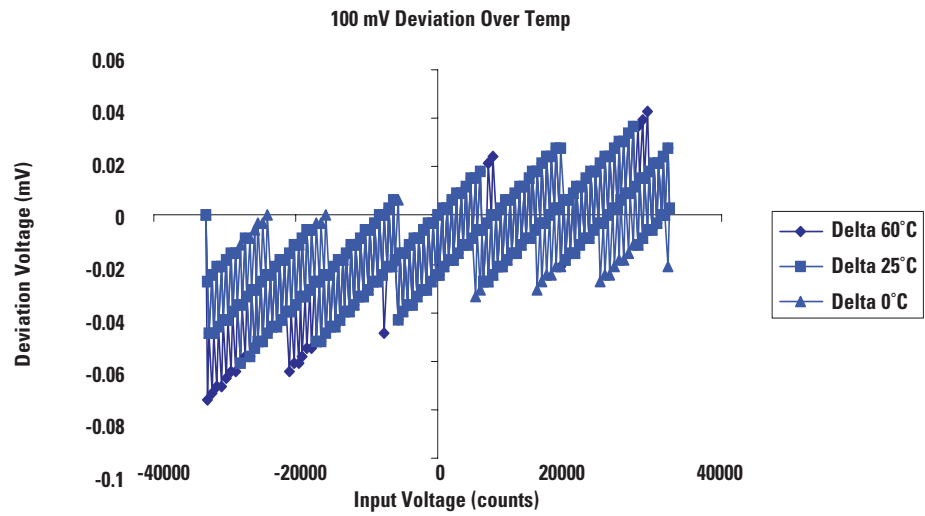

**uV Err, ±50mV Span, Prop Cts, 60 Hz, 25°C**

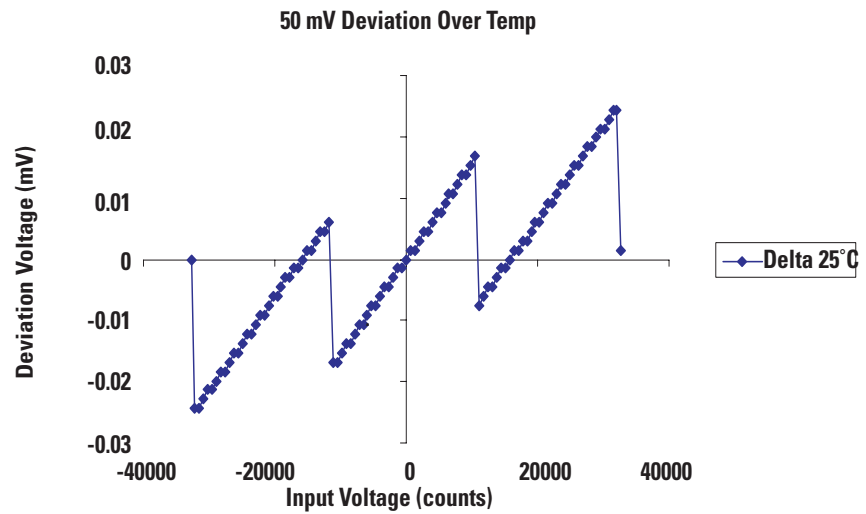



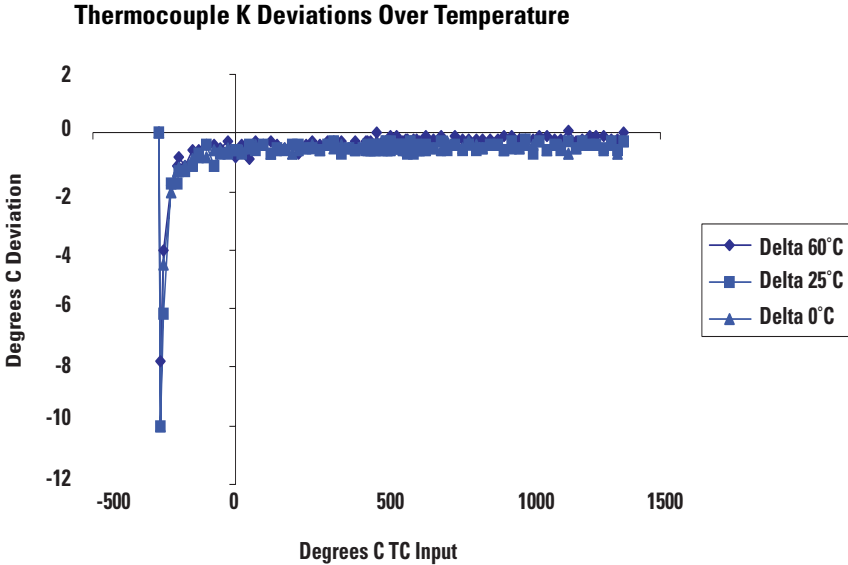
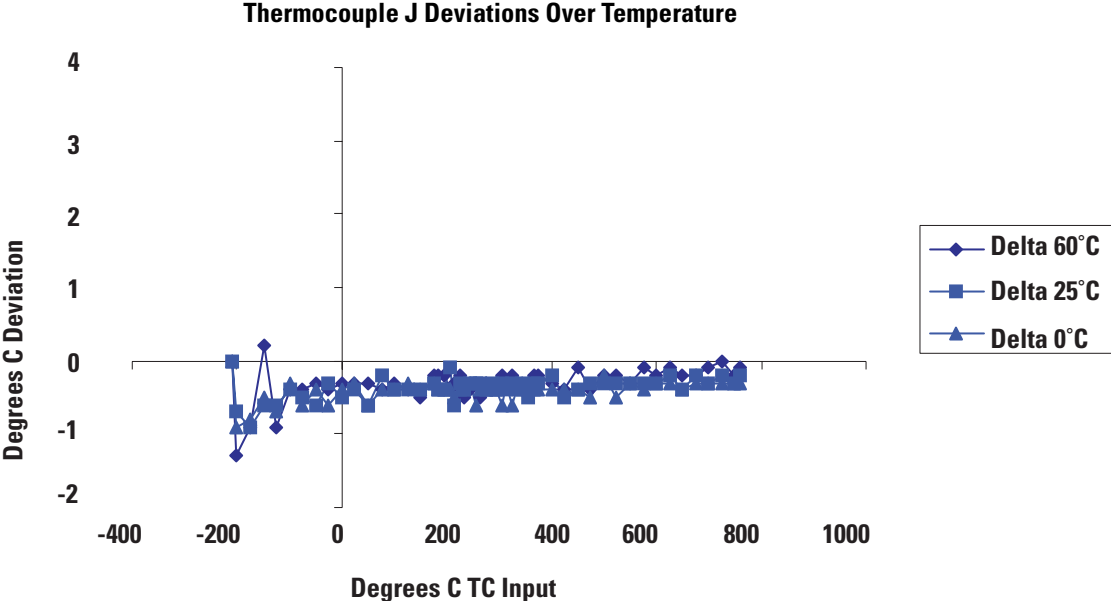

Thermocouple T Deviations Over Temperature

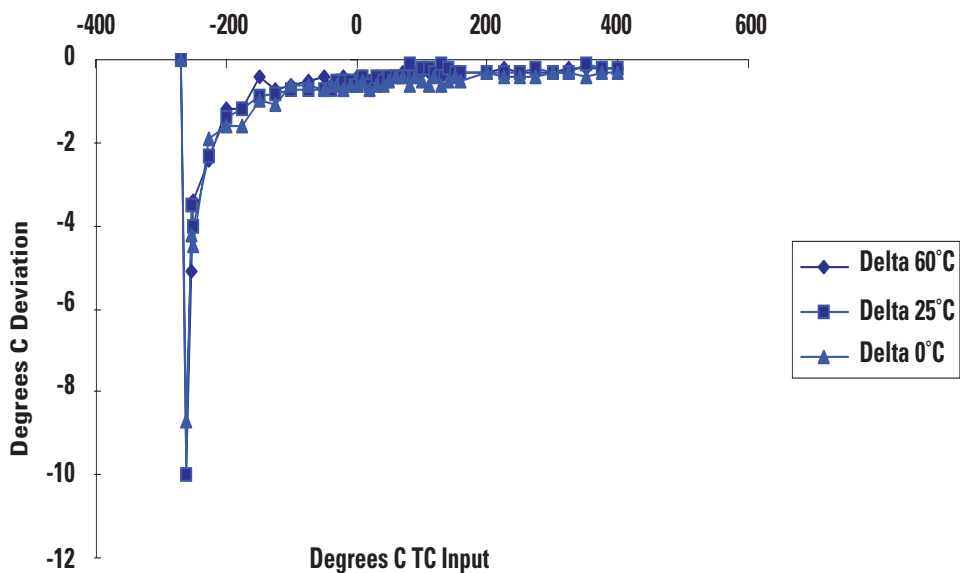

Thermocouple E Deviations Over Temperature

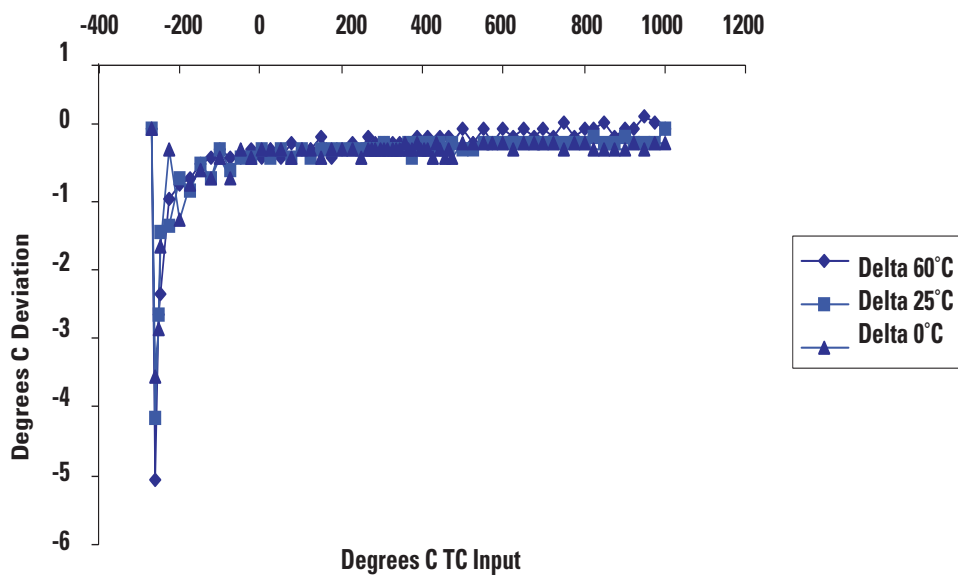

**Thermocouple B Deviations Over Temperature**

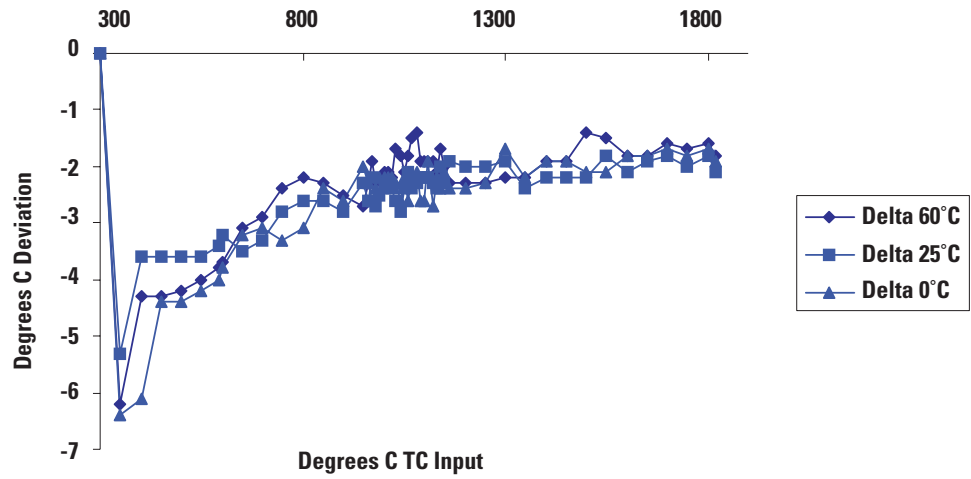

**Thermocouple N Deviations Over Temperature**

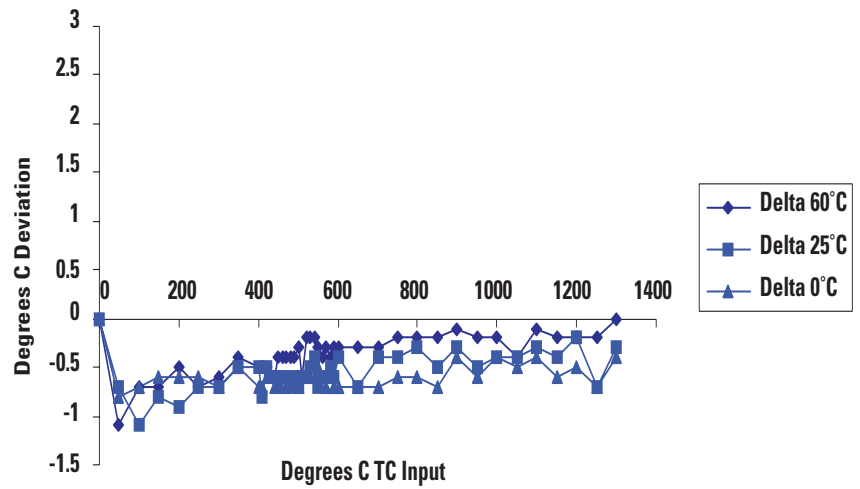



## Using Grounded Junction, Ungrounded Junction, and Exposed Junction Thermocouples

This appendix describes the types of thermocouples available and explains the trade-offs in using them with the 1746-NT8 module.

### Thermocouple Types

There are three (3) types of thermocouple junctions:

- **Grounded Junction** - The measuring junction is physically connected to the protective sheath forming a completely sealed integral junction. If the sheath is metal (or electrically conductive), then there is electrical continuity between the junction and sheath. The junction is protected from corrosive or erosive conditions. The response time approaches that of the exposed junction type.
- **Ungrounded Junction** - The measuring junction is electrically isolated from the protective metal sheath. This may also be referred to as an insulated junction. This type is often used where noise would affect the reading and for frequent or rapid temperature cycling. The response time is longer than the grounded junction.
- **Exposed Junction** - The measuring junction does not have a protective metal sheath, so it is exposed. This junction style provides the fastest response time but leaves the thermocouple wires unprotected against corrosive or mechanical damage.

The following illustrations show each of the three (3) thermocouple types.

### Grounded Junction

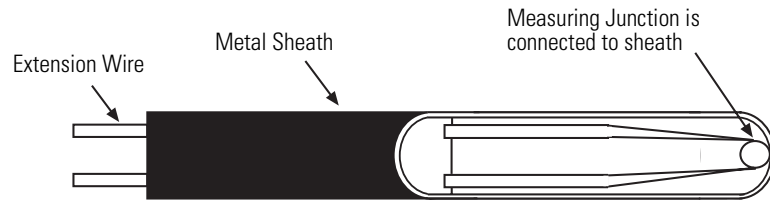

### Ungrounded (Insulated) Junction

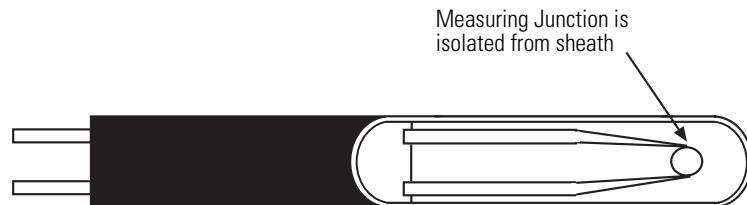

### Exposed Junction

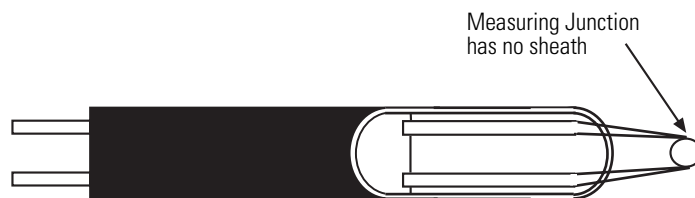

## Isolation

The 1746-NT8 module provides the following electrical isolation:

- 12.5V dc electrical isolation channel-to-channel
- 500V dc electrical isolation channel-to-chassis ground
- 500V dc electrical isolation channel-to-backplane

Care must be taken when choosing a thermocouple type and connecting it to the 1746-NT8 module from the environment being measured. If adequate precautions are not taken for a given thermocouple type, the electrical isolation of the 1746-NT8 module may be compromised.

## Grounded Junction

As shown in the following illustration, the shield input terminals are internally connected together, which are then connected to chassis ground. Using grounded junction thermocouples with electrically conductive sheaths removes the thermocouple signal to chassis ground isolation of the module. This is inherent to the thermocouple construction. In addition, if multiple grounded junction thermocouples are used, the module's channel-to-channel isolation is removed since there is no isolation between signal and sheath and the sheaths are tied together. It should be noted that the isolation is removed even if the sheaths are connected to chassis ground at a location other than the module, since the module is connected to chassis ground.

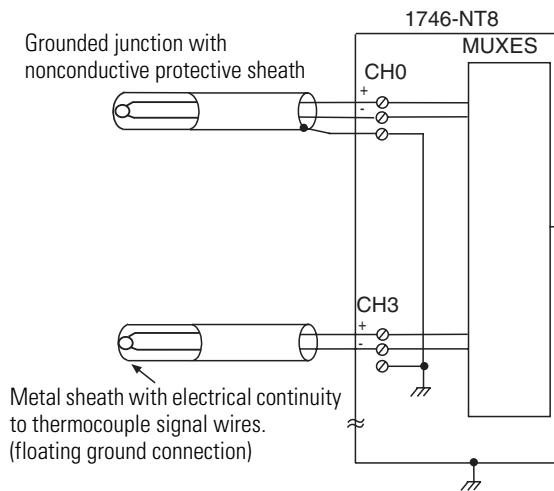

For grounded junction thermocouples, it is recommended that they have protective sheaths made of electrically insulated material (e.g. ceramic), or the metal protective sheaths be floated. The metal sheaths would need to be floated with respect to any path to chassis ground or to another thermocouple metal sheath. This means the metal sheath must be insulated from electrically conductive process material and have all connections to chassis ground broken. It should be noted that a floated sheath may result in a less noise immune thermocouple signal.

## Exposed Junction Thermocouples

Recommended wiring for exposed junction thermocouples is shown in the following illustration. Using exposed junction thermocouples may result in removal of channel-to-channel isolation. This may occur if multiple exposed thermocouples are in direct contact with electrically conductive process material. To prevent violation of channel-to-channel isolation:

- For multiple exposed thermocouples, do not allow the measuring junction of the thermocouple to make direct contact with electrically conductive process material.
- Use all ungrounded junction thermocouple instead of the exposed junction type.

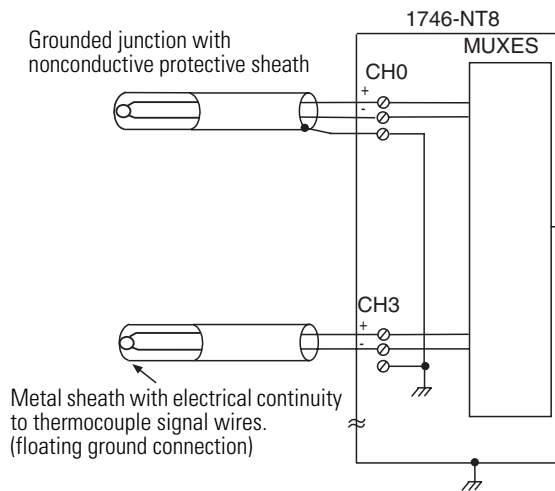



## Configuring the 1746-NT8 Module with RSLogix 500

This appendix describes how to configure the NT8 module with RSLogix 500 v6.10 or higher. To configure your module:

1. Access the I/O Configuration menu.
2. Determine the chassis number and slot location of where the NT8 module is located. Highlight the module.

### I/O configuration menu

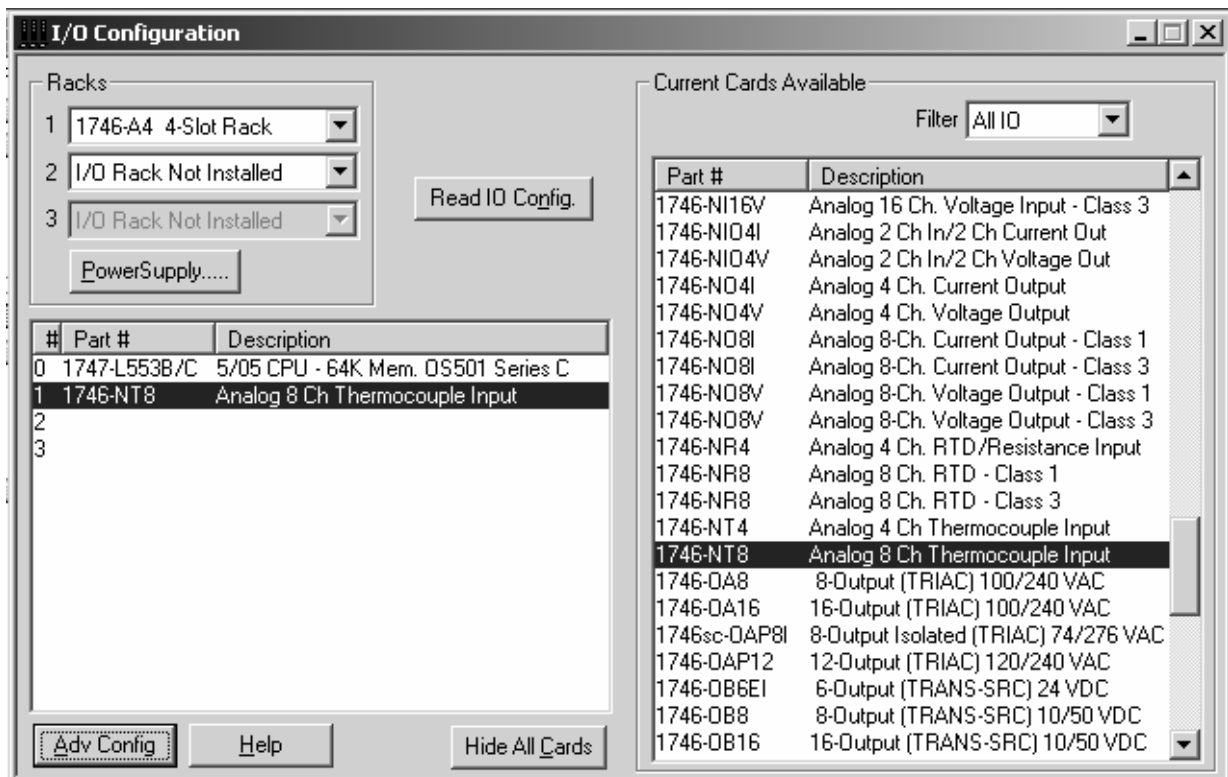

3. Press the Adv. Config button.

The following dialog box appears.

**Adv. Configuration menu**

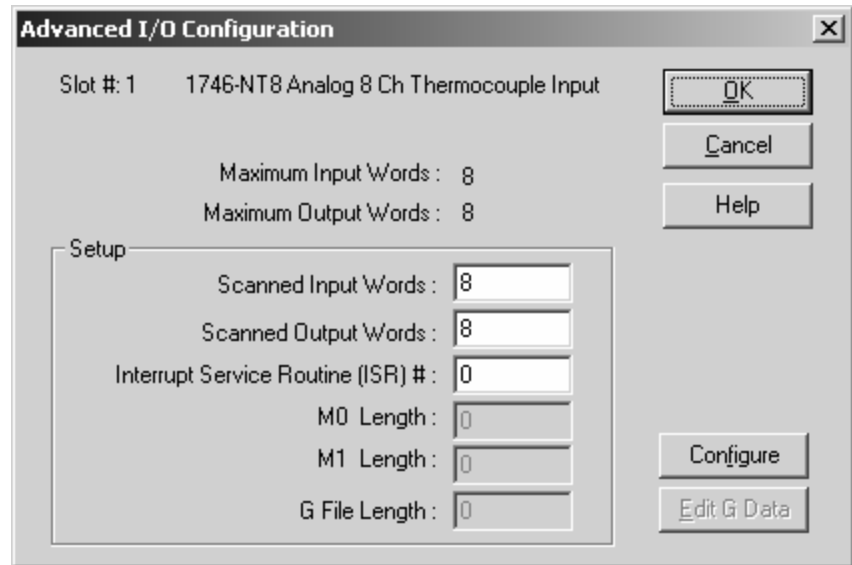

4. Press the Configure button.

The following dialog box appears. This allows you to configure options for each channel.

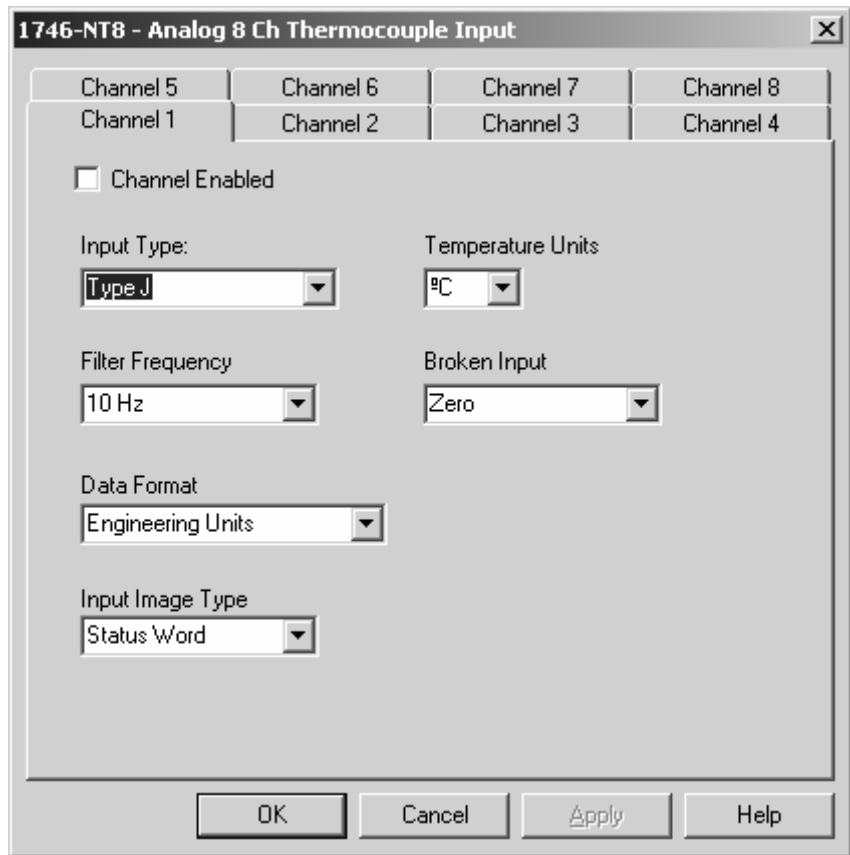
**Module configuration Options**

The dialog box allows you to access the parameters for all channels. Each tab has an identical menu with the parameters shown.

**Menu Options**

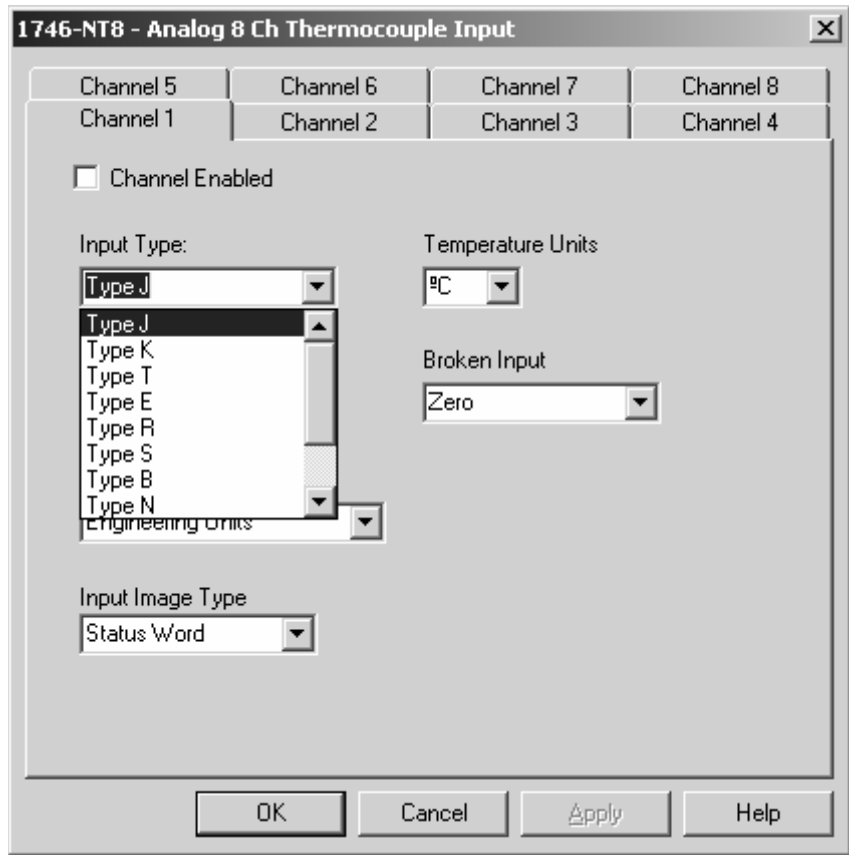

Opening the drop down menus of the various parameters shows the available choices. The following summarizes the different options for each parameter.

Parameter	Description
Channel Enabled	Controls bit 0 of the configuration file and sets whether the channel is being used.
Input Type	Sets bits 1 to 4 and sets the type of thermocouple being used.
Temperature Units	Sets bit 9 for temperature (°C or °F).
Filter Frequency	Sets bits 10 and 11 and determine the frequency of the channel filter.
Broken Input	Sets bits 7 and 8 and determines how to handle an open circuit condition.
Data Format	Sets bits 5 and 6 and determines the scale of the data.
Input Image Type	Sets the input to status word or data word and sets bit 15.

Each tab edits the word of configuration data for that channel for a total of 8 words of configuration data.

5. Press OK to set the parameters.

The following dialog box appears.

**Added Rung Parameters**

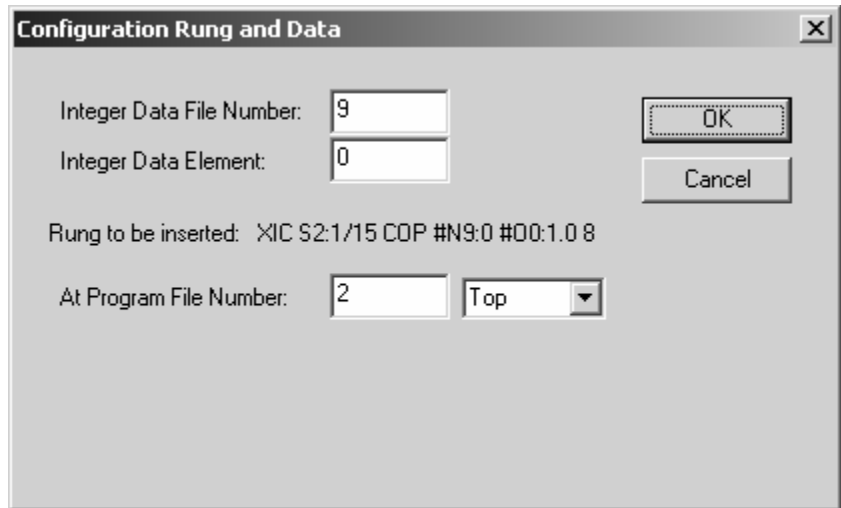

6. Choose the data file for the configuration and the location for the configuration rung within your ladder logic program.
7. Press **OK**.

The following rung is inserted into the program.

**Rung Inserted into program logic**

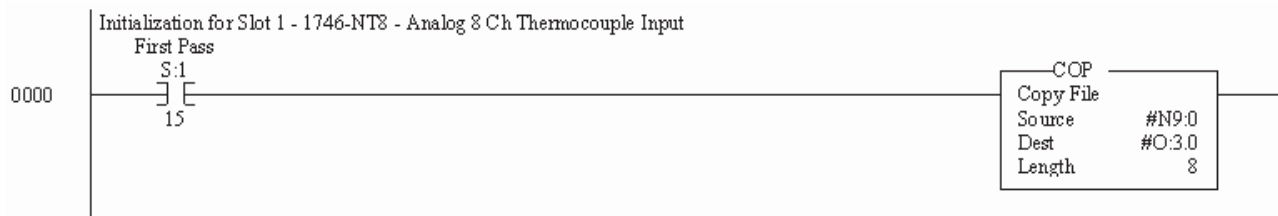

This rung sends the configuration to the module on the first program scan. The source and destination of the COP instruction may change depending on what you entered in the channel tab and the module location.



You should understand the following terms and abbreviations before using this guide.

### **A/D**

Refers to analog-to-digital conversion. The conversion produces a digital value whose magnitude is proportional to the instantaneous magnitude of an analog input signal.

### **Attenuation**

The reduction in magnitude of a signal as it passes through a system. The opposite of gain.

### **Channel**

Refers to one of eight, small-signal analog input interfaces to the modules' terminal block. Each channel is configured for connection to a thermocouple or DC millivolt (mV) input device, and has its own configuration and status words.

### **Chassis**

A hardware assembly that houses devices such as I/O modules, adapter modules, processor modules, and power supplies.

### **CJC**

(Cold-Junction Compensation) The means by which the module compensates for the offset voltage error introduced by the temperature at the junction between the thermocouple lead wire and the input terminal block (the cold junction).

### **Common mode rejection ratio (CMRR)**

The ratio of a device's differential voltage gain to common mode voltage gain. Expressed in dB, CMRR is a comparative measure of a device's ability to reject interference caused by a voltage common to its terminal relative to ground.

### **Common mode voltage**

The voltage difference between the negative terminal and analog common during normal differential operation.

**Configuration word**

Contains the channel configuration information needed by the module to configure and operate each channel. Information is written to the configuration word through the logic supplied in your ladder program.

**Cut-off frequency**

The frequency at which the input signal is attenuated 3 dB by the digital filter. Frequency components of the input signal that are below the cut-off frequency are passed with under 3 dB of attenuation for low-pass filters.

**dB (decibel)**

A logarithmic measure of the ratio of two signal levels.

**Data word**

A 16-bit integer that represents the value of the analog input channel. The channel data word is valid only when the channel is enabled and there are no channel errors.

**Digital filter**

A low-pass filter of the A/D converter. The digital filter provides high-frequency noise rejection.

**Effective resolution**

The number of bits in the channel data word that do not vary due to noise.

**Full-scale error (gain error)**

The difference in slope between the actual and ideal analog transfer functions.

**Full-scale range (FSR)**

The difference between the maximum and minimum specified analog values.

**Gain drift**

The change in full-scale transition voltage measured over the operating temperature range of the module.



**Input data scaling**

Depends on the data format that you select for the channel data word. You can select from scaled-for-PID or Engineering Units for millivolt, thermocouple, or CJC inputs, which you must compute to fit your application's temperature or voltage resolution.

**Local system**

A control system with I/O chassis within several feet of the processor, and using 1746-C7 or 1746-C9 ribbon cable for communication.

**LSB (least significant bit)**

The bit that represents the smallest value within a string of bits. The "weight" of this value is defined as the full-scale range divided by the resolution.

**Multiplexer**

A switching system that allows several input signals to share a common A/D converter.

**Normal mode rejection (differential mode rejection)**

A logarithmic measure, in dB, of a device's ability to reject noise signals between or among circuit signal conductors, but not between the equipment grounding conductor or signal reference structure and the signal conductors.

**Remote system**

A control system where the chassis can be located several thousand feet from the processor chassis. Chassis communication is via the 1747-SN Scanner and 1747-ASB Remote I/O Adapter.

**Resolution**

The smallest detectable change in a measurement, typically expressed in engineering units (e.g.  $0.15^{\circ}\text{C}$ ) or as number of bits. For example, a 12-bit value has 4,096 possible counts. It can therefore be used to measure 1 part in 4096.

**Sampling time**

The time required by the A/D converter to sample an input channel.

**Status word**

Contains status information about the channel's current configuration and operational state. You can use this information in your ladder program to determine whether the channel data word is valid.

**Step response time**

The time required for the A/D signal to reach 95% of its expected, final value, given a full-scale step change in the input signal.

**Update time**

The time for the module to sample and convert a channel input signal and make the resulting value available to the SLC processor.

**A**

**addressing** 3-2  
**auto calibration** 3-8  
**automatic monitoring thermocouples  
and CJC sensors** 5-3

**B**

**before using module** 3-1  
**block diagram** 1-6

**C**

**cables** 2-9  
**channel configuration** 4-1  
**channel configuration procedure** 4-2

- data format select 4-5
- effective resolutions 4-6
- input types select 4-5
- select channel enable 4-5
- using scaled for PID and proportional  
counts 4-6

**channel cut off frequency** 3-4  
**channel data and status word** 4-11  
**channel diagnostics** 6-1  
**channel enable select** 4-5  
**channel filter frequency selection** 3-3  
**channel reconfiguration times** 3-8  
**channel status checking** 4-12

- channel error 4-15
- channel filter frequency 4-15
- channel status 4-14
- data format type status 4-14
- input type status 4-14
- open circuit 4-15
- open circuit type status 4-14
- over range error 4-15
- temperature units type status 4-14
- under range error 4-15

**channel step response** 3-6  
**channel turn off** 3-8  
**channel turn on** 3-8  
**cold junction compensation** 2-11  
**config words** 3-2  
**configuration**

- with RSLogix 500 B-1

**D**

**data words** 3-3  
**diagnostic LEDs** 1-3

**diagnostics at powerup** 6-1  
**diagnostics channel** 6-1

**E**

**electrical specifications** A-1  
**electrostatic damage** 2-1  
**environmental specifications** A-2

**F**

**fixed I/O chassis module compatibility**  
2-3  
**fixed I/O current draw** 2-3

**G**

**general considerations** 2-4  
**general description** 1-1

- diagnostic LEDs 1-3
- hardware features 1-2
- input ranges 1-1

**H**

**hardware features** 1-2

**I**

**ID code** 3-1  
**input image data words and status  
words** 3-3  
**input ranges** 1-1

- millivolt input ranges 1-2
- thermocouple temperature ranges 1-1

**input specifications** A-3

- millivolt A-4
- overall accuracy A-4
- thermocouple A-6

**install** 2-5  
**installing the module** 2-1  
**interfacing to PID instruction** 5-7  
**interpreting IO error codes** 6-5  
**isolation** B-2

- exposed junction B-4
- grounded junction B-3

**L**

**LED troubleshooting** 6-3  
**linear millivolt device compatibility** 1-7

## M

- millivolt input ranges** 1-2
- modular system** 2-2
- module addressing** 1-5, 3-2
  - input image data words and status words 3-3
  - output image config words 3-2
- module and channel diagnostics** 6-1
- module general description** 1-1
- module ID code** 3-1
- module install** 2-5
- module operation** 1-5
- module removal** 2-5
- monitoring channel status bits** 5-8

## O

- output image config words** 3-2
- overview** 1-1

## P

- physical specifications** A-2
- PLC 5 example** 5-13
- power requirements** 2-2
  - fixed I/O chassis compatibility 2-3
  - modular system 2-2
- preparing and wiring cables** 2-9
- preventive maintenance** 7-1
- programming examples** 5-1

## S

- safety considerations** 7-1
- scaling examples** 4-7
  - channel filter frequency 4-10
  - input image type 4-11
  - open circuit state 4-9
  - temperature units 4-10
  - unused bits 4-11
- SLC 500 example** 5-15
- slot disabling** 3-9
  - input response 3-9
  - output response 3-9
- specifications**

- electrical A-1
- environmental A-2
- input A-3
- physical A-2
- status words** 3-3
- system operation** 1-4
- system overview** 1-3
  - block diagram 1-6
  - linear millivolt device compatibility 1-7
  - module addressing 1-5
  - module operation 1-5
  - operation 1-4

## T

- terminal block removal** 2-6
- thermocouple** A-6
- thermocouple temperature ranges** 1-1
- thermocouple types** B-1
  - exposed junction B-2
  - grounded junction B-2
  - insulated junction B-2
  - ungrounded junction B-2
- troubleshooting** 6-1
  - channel error 6-5
  - channel status LED 6-4
  - interpreting IO error codes 6-5
  - LED table 6-3
  - module status LED 6-5
  - open circuit detection 6-4
  - out of range detection 6-4

## U

- update time** 3-7
  - calculation 3-8

## V

- verifying configuration changes** 5-3

## W

- wiring module** 2-1, 2-7
  - cold junction compensation 2-11
  - preparing and wiring cables 2-9



# Rockwell Automation Support

Rockwell Automation provides technical information on the web to assist you in using our products. At <http://support.rockwellautomation.com>, you can find technical manuals, a knowledge base of FAQs, technical and application notes, sample code and links to software service packs, and a MySupport feature that you can customize to make the best use of these tools.

For an additional level of technical phone support for installation, configuration and troubleshooting, we offer TechConnect Support programs. For more information, contact your local distributor or Rockwell Automation representative, or visit <http://support.rockwellautomation.com>.

## Installation Assistance

If you experience a problem with a hardware module within the first 24 hours of installation, please review the information that's contained in this manual. You can also contact a special Customer Support number for initial help in getting your module up and running:

United States	1.440.646.3223 Monday – Friday, 8am – 5pm EST
Outside United States	Please contact your local Rockwell Automation representative for any technical support issues.

## New Product Satisfaction Return

Rockwell tests all of our products to ensure that they are fully operational when shipped from the manufacturing facility. However, if your product is not functioning and needs to be returned:

United States	Contact your distributor. You must provide a Customer Support case number (see phone number above to obtain one) to your distributor in order to complete the return process.
Outside United States	Please contact your local Rockwell Automation representative for return procedure.

[www.rockwellautomation.com](http://www.rockwellautomation.com)

### Power, Control and Information Solutions Headquarters

Americas: Rockwell Automation, 1201 South Second Street, Milwaukee, WI 53204-2496 USA, Tel: (1) 414.382.2000, Fax: (1) 414.382.4444

Europe/Middle East/Africa: Rockwell Automation, Vorstlaan/Boulevard du Souverain 36, 1170 Brussels, Belgium, Tel: (32) 2 663 0600, Fax: (32) 2 663 0640

Asia Pacific: Rockwell Automation, Level 14, Core F, Cyberport 3, 100 Cyberport Road, Hong Kong, Tel: (852) 2887 4788, Fax: (852) 2508 1846

Publication 1746-UM022B-EN-P - January 2005

Supersedes Publication 1746-6.22 - July 1999

Copyright © 2005 Rockwell Automation, Inc. All rights reserved. Printed in the U.S.A.