

Gas Turbine Reference Library

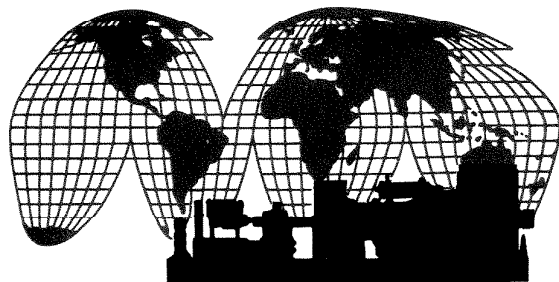

SPEED & TRONIC[®] **CONTROL SYSTEM**

Arne Loft

Manager—Gas Turbine Technical Support—Europe
Gas Turbine International Department
Gas Turbine Products Division, Schenectady, N.Y.

GENERAL  **ELECTRIC**

Copyright© 1972 General Electric Co.

Printed in U.S.A.

INTRODUCTION

The SPEEDTRONIC* control system has come of age.

From the first unit, installed in Long Island in 1968, to the ones being started today, 118 customers around the world have accumulated over 500,000 hours on about 300 SPEEDTRONIC controlled heavy-duty gas turbines, while the equipment itself has accumulated over 2 million hours on the electronics. These units are either in service or being installed in applications as varied as from utility to marine, and from pipe line to process combined cycles, with environments that vary from minus to plus 50C. A significant number of these are in overseas areas with about 80 located in Area Division Europe.

With approximately 50 printed circuit boards per control panel, this represents more than 100,000,000 electrical-board-hours under the most diversified, trying and demanding circumstances. Still, the SPEEDTRONIC running reliability accumulated so far has been over 99 percent.

But what is the SPEEDTRONIC Control System?

For a considerable period during the late '60's, the General Electric Company developed, prototyped and tested a solid-state, analog and digital gas turbine control, protection and sequential system with an integrated power supply. This system is designed to give GE gas turbines better performance. Specifically, it provides:

- Maximum starting and running reliability
- Fast response, accurate performance and longer life
- Adaptability to diversified gas turbine cycles and applications.

All controlling parameters – start-up, acceleration, speed, temperature, and load – are generated electrically, biased and computed electronically, and indicated and checked electrically. The output amplifiers drive servo valves utilizing high-pressure hydraulics for the hydraulic cylinder which employs direct electronic feedback, creating a system with no detectable dead band.

This SPEEDTRONIC control system is designed for all General Electric heavy-duty gas turbines – from 4000 hp individual units to 400 Mw combined cycles. These units are applied to turbines for electric utility peaking, base-load, or power block; for pipeline pumping; for compressor drives in industrial and chemical processes; for marine drives, and for locomotives. Thus, not all features de-

*Trademark of General Electric Co.

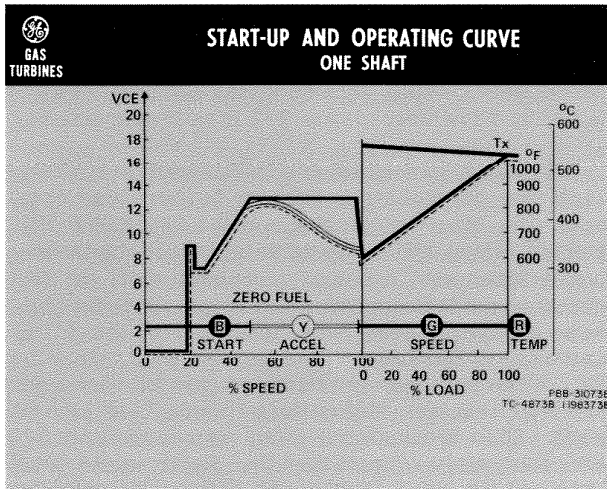

Figure 3

quiring the least fuel will take control. The output of this minimum value gate is the one basic output: VCE (electronic control voltage), which in turn determines fuel flow.

Into these three input loops may be fed a number of derived parameters, such as acceleration, as well as separate inputs, such as load. The output may, in turn, be split into dual values, such as the VCE splitter, for dual fuel, or separate outputs obtained such as required to control the speed ratio valve, variable second-stage nozzle, and the blow-off valve. To get a clearer picture of the control system, refer to the start-up and operating characteristic curve, Fig. 3.

Start-up Loop

The VCE level is determined by a number of pre-set values to obtain the proper fuel flow for cranking, firing, warm-up, acceleration and a maximum ceiling.

During the initial phase of the start-up, VCE is held at zero in order to keep fuel off until firing speed is reached and purging is completed (2TV). At that point, the start-up loop sets firing VCE. Upon detection of flame (28FD), VCE is cut back to warm-up in order to avoid thermal shock to the hot gas path parts. At the end of a warm-up period, whether it be a fixed one-minute warm-up (2W), as is normally the case with a cold machine, or whether it be the fact that the unit has reached suppressed temperature control, as may be the case with a warm unit, the VCE ceiling will rise to its acceleration value until intercepted by a ramp rate of temperature rise of normally 3C (5F) per second, said rate being the proper value for bringing the unit from the warm-up temperature level to the ac-

celeration temperature level. After a short while, the turbine will begin to accelerate faster because the efficiency of the unit is improving and the exhaust temperature will begin to decrease at a rate resembling the initial rate of rise. At this point, the acceleration control will take over, normally at about 1 (or 1/2) percent per second, cutting back fuel in preparation for the governor, again to avoid thermal shock. This gentle cut-back is a significant step towards longer life and lower maintenance. When operating speed has been reached, the preset VCE limits established for the above purposes are eliminated (14HS) and a ceiling, normally a little below 20 VCE, will be established as a back-up for the speed and temperature system.

Figure 4 shows schematically how these pre-set values are fed into the starting loop operational amplifier. While the speed and temperature loops are closed loops, the start-up loop actually is an open loop.

Speed Loop

The most important operating loop is the speed loop. It consists of the speed sensor, amplifiers, set-point and feedback, as well as appropriate pulse rate to analog converters, scaling resistors, etc.

On one-shaft machines, the speed signal comes from the inductor alternator or magnetic pick-ups, depending upon the application. On two-shaft units, a set of magnetic pick-ups is mounted by the load shaft to provide the speed signal, while the inductor alternator or magnetic pick ups provide the signal from the HP set (gas generator set).

The inductor alternator and magnetic pick-ups mounted on the compressor stub-shaft have an out-

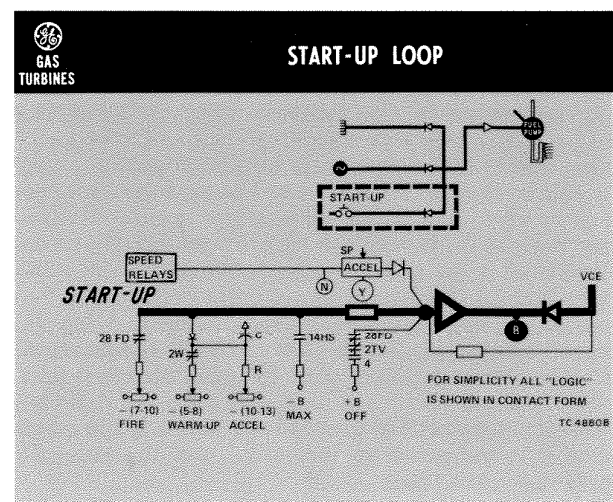

Figure 4

GAS TURBINES TURBINE CONTROL PANEL		
CONTROL	PROTECTION	SEQUENCING
INCL STATUS INDICATION	MONITOR-ALARM-TRIP	INCL STATUS INDICATION
START-UP ACCELERATION HP & LP SPEED TEMPERATURE & RATE VARIABLE NOZZLE LIQUID & GAS FUEL PULSATION LOAD PRECISE POWER MANUAL	OVERSPEED OVERTEMPERATURE VIBRATION FLAME GRND. OPEN & SHT CKT SPEED INDICATION TEMP INDICATION VIBRATION INDICATION ANNUNCIATION	NORMAL START FAST START MULTIPLE START NORMAL STOP EMERGENCY STOP ZERO SPEED DETECT FIRING SPEED DETECT SYNC SPEED DETECT IGNITION MCC PROGRAMMING
FAIL: PROCESS CONTINUE REDUNDANCY BY ASSOC	FAIL: TURBINE STOP DOUBLE REDUNDANCY	FAIL: TURBINE STOP MAX START RELIABILITY
POWER SUPPLY REDUNDANT OUTPUT • FAIL SAFE		
<small>PEB 31525A 1199352A TC 5393A</small>		

Figure 1

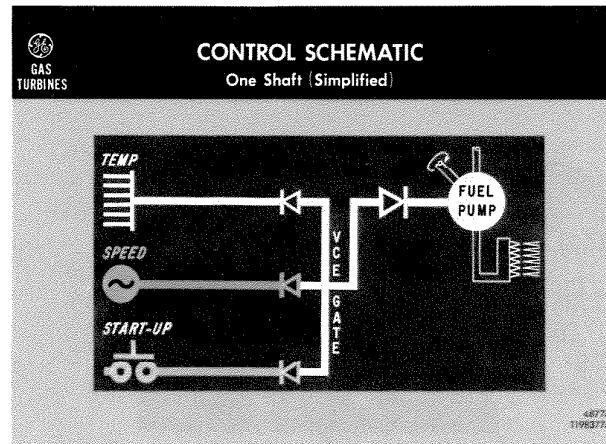

Figure 2

scribed in this paper apply to all applications or gas turbine models.

The Mark I system is presently running on several hundred machines. From experience gathered on these, plus additional computer studies, as well as field experience on a new prototype system, we have developed a second generation system: SPEED-TRONIC Mark II. This new control will further enhance reliability by a large reduction in the quantity of electronics and interconnecting wiring due to the increased utilization of the latest electronic technology in both the analog and digital systems. New micrologic circuits have been developed for both the sequential and the annunciator function, and IC's will be even more predominant in this new generation of controls for heavy-duty gas turbines.

DESIGN PHILOSOPHY

The SPEEDTRONIC control system can be divided into four functional parts (Fig. 1):

- Control System – normal operation.
- Protection System – independent back-up.
- Sequential System – logic required for automatic startup and shutdown.
- Power Supply System – self-contained, redundant system which makes the over-all system completely independent of external power.

Before proceeding with the design details of the four parts, it may be well to elaborate on the philosophy of the design employed in each area. It is important to think of what will happen in case of failure of a component, and how the system should be designed to give the customer the best possible operation in case of such a failure, while still protecting the prime-mover.

CONTROL SYSTEM

Philosophy

The failure mode, in case of the most likely type of failure that can be calculated or estimated, has been designed to be a "process continue" type of failure. This means what normally might be thought of, from a prime-mover point of view, as fail unsafe, but it gives the customer a "process fail-safe" unit. It allows the gas turbine to continue to perform its function in spite of a control failure, a big step toward high running reliability. To back this up, we have built into the system "redundancy by association". By this, we mean that when the system is operating on one control, such as temperature control, the speed control will back it up and vice-versa. In this way, redundancy is obtained without adding a myriad of components.

Design

The standard one-shaft control system consists of three major input loops (Fig. 2); startup, speed, and temperature. The output of these are fed into a minimum value gate, where the parameter re-

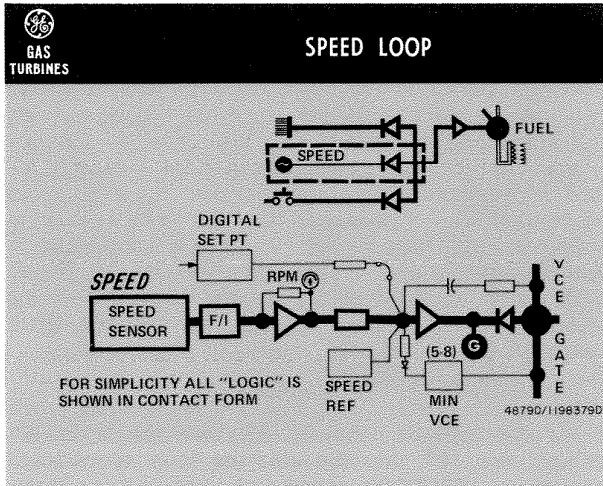

Figure 5

put frequency that is equal to the turbine rpm, a handy feature in many respects. There are 60 teeth on the rotor; 60 pulses per revolution will be obtained. For instance, at 5100 rpm, which is the speed of the MS 5000 gas turbine at full speed, 5100 x 60 cycles per minute, or 5100 Hz, will be obtained. This high frequency is fed into the pulse rate to analog converter, the output of which goes into the speed amplifier (Fig. 5) whose output voltage then is proportional to speed and is used for speed control, speed indication, speed level sensors, and for deriving the acceleration signal for all acceleration control. This speed signal is fed to the summing junction of the speed loop operational amplifier where it is summed with the set-point, the 100 percent speed reference, and the feedback. By utilizing a high-frequency signal, better analog signals as well as faster and more accurate response to transients is obtained. Considering a generator drive unit, the speed reference can be assumed to be set at 100 percent. The digital set point may be at any value above or below this 50/60 Hz synchronous speed, but in the most common case, it will be set just above for fast synchronizing which can thus occur a few seconds after reaching full-speed. It also makes the unit generate an output instantly after breaker closing. VCE is fed back through droop resistors to that summing junction, thus determining the gain of the speed loop. The full-speed no-load bias is set to cancel the influence of the FSNL fuel flow on the range and set point of the other four inputs. Thus, when these five inputs: speed and speed reference, FSNL bias and VCE feedback, as well as the set-point, sum to zero, the system is satisfied and the unit is on speed control. Actually, with the speed at 100 percent and no load, the inputs cancel in the pairs as indicated, and the set-point provides zero input.

The loading rate (from no-load to full-load) is limited to 4 or 12 minutes depending on the application and model. For dead-load pick-up and fast emergency loading, this rate may optionally be reduced to a few seconds and 1/2 minute respectively.

Normally, generator drive units will be operated at about 4-percent droop in order to share load properly with other generating units. SPEEDTRONIC control offers optionally an automatic instantaneous conversion, with minimal frequency shift, to isochronous mode for isolated operation. With its high-accuracy speed reference, it allows 60 (or 50) Hz operation regardless of load and will hold within 0.1 Hz. When parallel operation is again required, the unit will transfer to the droop mode with no load shift. This isochronous mode is accomplished by simultaneously eliminating the steady-state feedback and the FSNL bias (by 83 FC), while retaining the transient feedback, thus making the speed loop an integrator.

Both the HP (gas generator) set and LP (load turbine) on two-shaft turbines are generally operated in the isochronous mode for optimum part load, off-ambient and transient performance.

Temperature Loop

The other main control loop is the temperature loop. Its main purpose is to limit the start-up and operating temperature of the gas turbine to safe values.

Exhaust temperature is used as the prime parameter, rather than turbine inlet temperature. Turbine inlet temperature, in relation to the stationary turbine nozzles, is an important factor, as is the temperature of the first-stage buckets. Inter-stage passages as well as the exhaust ducting, which is made of low alloy steel, have temperature limitations. This, coupled with requirements for long sensor life, good sampling, serviceability, etc., makes the choice of exhaust versus turbine inlet temperature a natural. While sensing and limiting the exhaust temperature, the system is designed to also limit the turbine inlet temperature to the design value through proper component gains and biases.

The sampling of the exhaust gases to obtain a true picture of the average exhaust temperature is important. Through test in the factory and in the field, and with the use of statistical analysis, a "twelve even area" criteria was developed. This criteria gives an average deviation from the mean of less than five degrees, based on fifty degrees spread in the exhaust duct. Actual measured spread in the exhaust is normally less than this value, as-

sureing even better control. This symmetrical arrangement furthermore enables experienced personnel to detect irregularities in the combustion system, such as plugged fuel nozzles, etc. (Fig. 6).

Thus, for control, the exhaust temperature is sensed by 12 fast-acting thermocouples in the exhaust duct. The outputs are averaged and cold junction compensated in a thermocouple averaging system with individual CHECK/AVERAGE/REJECT switches that allow the operator to check individual thermocouple outputs while running. These switches are located on the front of the SPEEDTRONIC control panel for easy access. Should a thermocouple be open or shorted the switch is thrown to REJECT. The average is only affected to the extent of 1/12 of the deviation of that particular thermocouple from the average. Several more thermocouples can be rejected if need be, without materially affecting the average. However, experience has shown that many years of service can be expected from these thermocouples due to their stainless steel sheath and rugged construction.

To obtain good response and accuracy requires high convection, low radiation and low conduction design. To obtain long life, good material (in regard to stress and corrosion) and good mechanical design (primarily to avoid vibration and transportation damage) are the prime requirements.

Figure 7 shows a cross-section of the thermocouple tip as well as the thermocouple assembly.

The thin-walled radiation shield is oriented in the direction of flow, exposing the 1.6 mm (1/16-inch) O.D., swaged magnesium oxide, fully-enclosed iron-constantan or chromel-alumel thermocouple to the high-velocity gas stream. This arrangement produces a fast, accurate, and reliable sensor with a time constant of about three seconds. The output of the system is fed into the MV/V (milli-

volt to volt) amplifier (Fig. 8). Thus, a voltage proportional to temperature from approximately 40-700C (100-1300F) is obtained and can be displayed on the exhaust temperature meter. The difference between the temperature signal and the temperature reference is amplified in the maintemperature amplifier. Feedback for this amplifier is provided from the VCE voltage. In other words, when the temperature, the temperature set point and the feedback sum to zero, the temperature system is in control.

Power-Control Loop

Marine units have a fourth loop, a power-control loop, for part-load control of the gas turbine. The speed-control loop on these units becomes an operating limit, i. e. a topping governor to provide backup speed control during transients.

Fuel Servo Loop

VCE is fed to the fuel control (Fig. 9) through an operational amplifier to the servo valve and hydraulic cylinder. VCE is amplified, fed to the servo valve and stabilized with feedback. The servo valve controls the hydraulic cylinder, the position of which is fed back by way of LVDT's (Linear Variable Differential Transformers), or RVDT's (Rotary Variable Differential Transformers) and three kilohertz oscillator/detectors to the amplifier. In this manner, the servo valve is allowed to operate fully open until the stroke of the cylinder almost reaches the desired value, the speed of response being very much increased by this feature. In addition, the "universal liquid fuel system" uses speed feedback from the flow divider.

Servo Valves

The SPEEDTRONIC control system can operate satisfactorily with a wide variety of servo valve

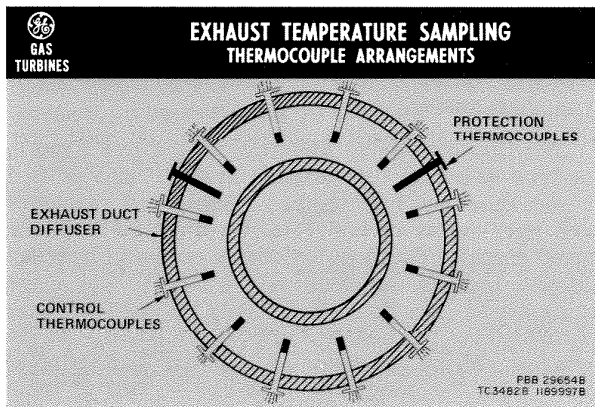

Figure 6

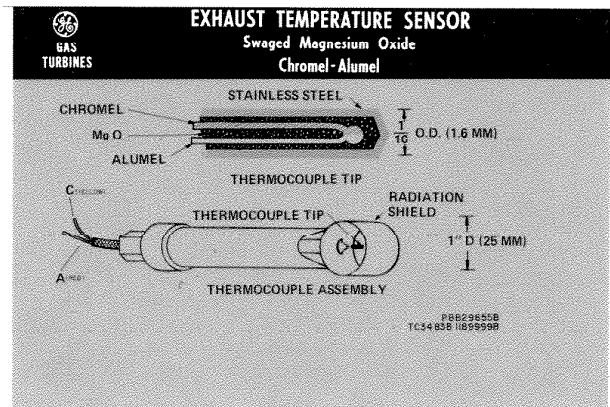

Figure 7

types. However, based on controlled contamination tests, performed by independent laboratories, it has been determined that the spool-type valve performs reliably with high levels of fluid contamination. Hence, we have standardized on this type for the gas valves and nozzle actuating cylinder. The servo valve type used in conjunction with the fuel pump has sometimes been of a different design since these servo valves generally are an integral part of the liquid fuel pump and its control. Servo valves control the flow of fluid to and from a load actuator in proportion to the input current signal to the torque motor. For the spool-type servo valve, high pressure oil, at about 100 atmospheres (1200-1600 psi) is introduced into cavities marked P as shown in Fig. 10. In the case of double acting cylinders (such as the nozzle cylinder), the ports marked 1 and 2 are connected to the load actuator; for single acting cylinders (such as gas control valves) only port 1 is connected. Cavity R is a return line. The four torque motor leads, constituting two separate coils, are driven from the servo amplifier. In actual operation, the second-stage displacement (and hence the oil flow) is proportional in magnitude and direction to the current signal to the torque motor. The spool is precisely controlled by a push-pull, frictionless, force feedback servo system.

In order to make sure that a failure does not shut down the machine, if it can possibly be avoided, but also to assure that no failure goes undetected, servo valves with dual coils are used. Also on most models the LVDT's utilized actually are dual LVDT's and detectors. Thus, should a servo valve coil, an LVDT, its oscillator or discriminator become disabled, or shorted, or a wire become disconnected, an alarm will be sounded, but the unit will continue to operate as designed, with undetectable shift in load or speed.

That basic system applies whether a liquid fuel pump or a gas control valve is used. In the case, however, of a gas system, an additional valve is required in order to make fuel flow a function of VCE and speed. Since the fuel pump is driven directly through gears from the turbine, its fuel flow is automatically a function of speed and since stroke is linear with VCE, the output becomes a product of the two. In like fashion, a speed ratio valve is used in the gas system in order to give the gas control valve an input pressure which is a function of speed. The speed ratio valve gets its signal from the voltage output of the speed amplifier as mentioned above, and a transducer of the pressure into the gas control valve. These values are fed into an operational amplifier similar to the ones used for the gas and oil systems and similar servo valves and cylinders are used. Only a single LVDT is used for the speed ratio valve, since failure of that LVDT is made to result in a wide open valve. The gas control valve, in turn, can maintain speed or temperature as required with a minimal error as determined by the gain of the system. This single LVDT will probably become standard for all three output systems after considerable experience has been obtained verifying the reliability of the feedback systems. The MS 1000 is now running utilizing only single LVDT's.

Universal Fuel System

The new Universal Fuel System, schematically described in Fig. 11 makes use of field-proven components from earlier systems. This system is designed to handle all liquid fuels, from naphtha on the light end, through the entire distillate range, to crude and residual oils on the heavy end. After proper proof testing is completed, the Universal Fuel System is expected to replace our present variable-displacement pump system. The major components are: Main fuel pump, a free-wheeling flow divider equipped with speed sensors, and an electro-hydraulically controlled bypass valve.

The main fuel pump is a fixed-displacement, gear-type pump virtually identical to the one used in our earlier universal flow divider system. It is driven by the accessory gear and incorporates pressure loaded side plates and mechanical-face-type shaft seals.

The flow divider is identical to the one used in the free-wheeling flow divider system, except that it incorporates two toothed-wheels and magnetic pick-ups, one at each end, to provide a flow divider speed signal. The flow divider, a series of hydraulic gear motors, mechanically linked to run at the same speed, has thus again taken on the dual role of measuring the flow and dividing it equally to the nozzles. Since its speed is a linear indication of fuel flow, the magnetic pick-ups - two of them through a high-value gate for running reliability - provide the fuel flow signal for the feedback.

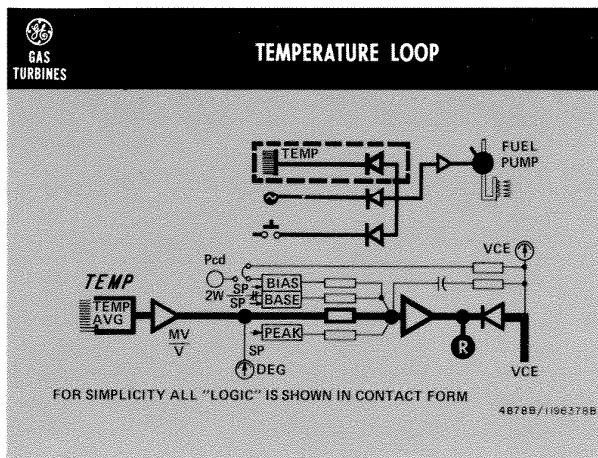

Figure 8

CONTROL SCHEMATIC ONE SHAFT (SIMPLIFIED)

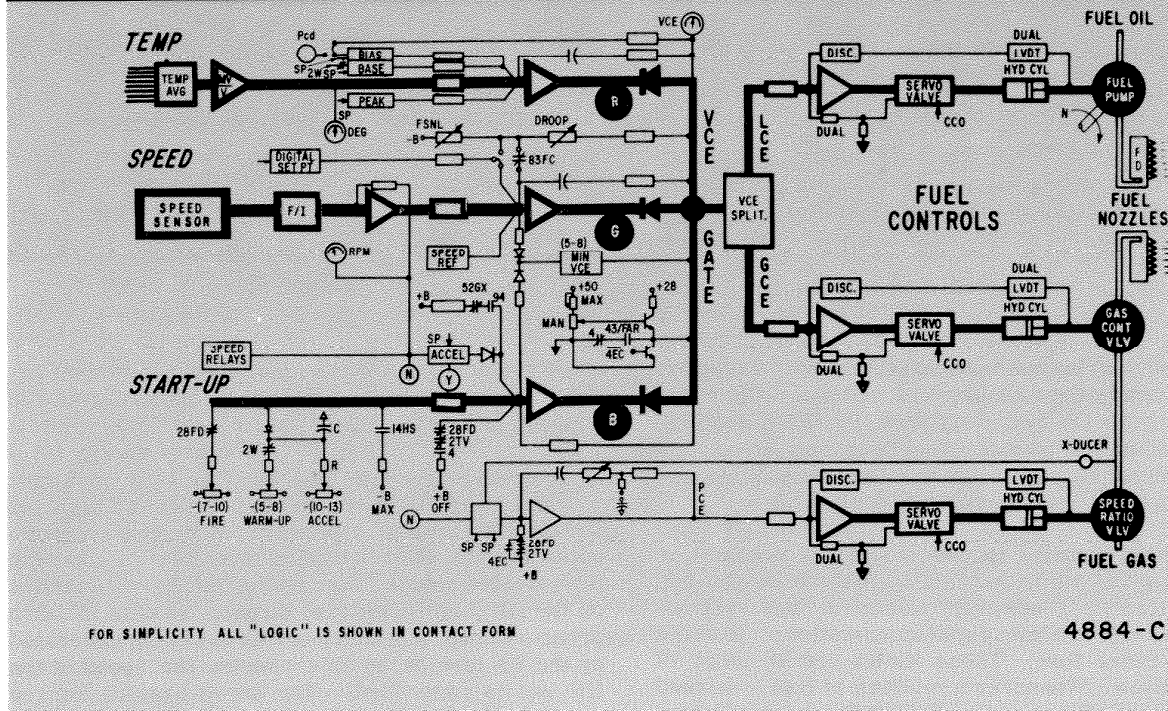

Figure 9

The bypass valve is a simple plug valve actuated by a hydraulic cylinder which in turn is commanded by an electro-hydraulic servo-valve mounted directly on the cylinder. The control system commands a turbine fuel flow ($FCE = VCE' \times N$; where $VCE' = VCE - 4$) which is compared to the flow divider speed feedback signal. The error signal is fed to the bypass valve amplifier that strokes the valve to feed the flow divider the proper flow by dividing the main pump discharge flow into two paths - one to the flow divider and one back to main pump suction. The resultant flow divider speed change will thus "nul" the bypass valve input, keeping it at its new position.

VCE Splitter For Dual Fuel

The SPEEDTRONIC control incorporates a very commonly used option: Dual fuel. To effect a transfer from one fuel to another it is necessary to split the VCE signal into two parts, the sum of which acts similarly to the individual fuel system before the transfer. The transfer may be divided into three functions: (1) the establishment of initial conditions, (2) a line filling time of approximately 30 seconds,

and (3) the actual transfer, which also takes 30 seconds. Figure 12 shows a transfer from gas to oil. Initially the LCE signal, which is a signal to the liquid fuel system, will jump up to slightly more than 4 on the VCE meter. This will initiate a slight oil flow to the liquid fuel nozzles, allowing the fuel lines to get filled. During this time the GCE, which is the VCE signal going to the gas control system, is held equal to VCE to make sure there is no decrease in fuel flow - thus power - while the fuel system is getting ready for operation, (i.e. valves opened, lines filled etc). This 30 second period will actually result in a fuel increase when the lines are filled, unless the unit is on speed governing, temperature control, or load control, in which cases VCE will automatically decrease to hold the total fuel flow constant.

For emergency conditions, such as loss of fuel gas pressure, the 30 second fill time can automatically be by-passed, resulting in a less smooth, but substantially faster, transfer. After the 30 seconds, the actual transfer will be initiated with the GCE decreasing linearly to 4 from wherever it was, and the LCE increasing linearly to whatever the VCE

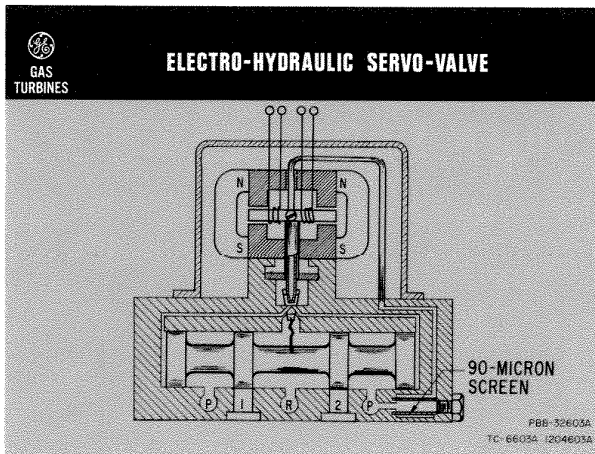

Figure 10

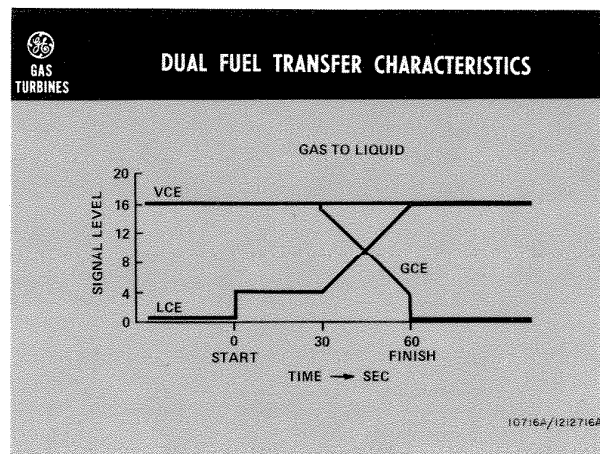

Figure 12

value is. During the transfer the sum of the active VCE, namely the LCE above 4 and the GCE above 4 still equals the active VCE or the VCE above 4. As soon as the transfer has been completed, the GCE will go to zero with the LCE remaining undisturbed at the VCE value.

The fuel transfer may be stopped at any time, in other words, while burning a mixture of gas and oil. There are, however, minimum fuel restrictions in order to achieve good atomization or to avoid hot gas cross-flow. These limits are at about 10 percent flow. Whenever a mixture of fuel is burned and the load changes, the VCE will respond in the normal manner and the LCE and GCE values will respond proportionately.

Two-Shaft Operation

The fuel control system for two-shaft machines utilizes exactly the same basic system as the one-

shaft version. In addition, however, since the two-shaft unit uses a variable second-stage nozzle and has an additional shaft, some additional control loops are required (Fig. 13). The total energy level is determined by fuel flow similar to a one-shaft machine, while the energy split between the high and low-pressure sets is determined by the pressure ratio across their respective turbines. Opening the variable nozzle, decreasing the back pressure on the HP (high-pressure) turbine, results in more pressure drop, and thus more torque being generated by the HP turbine; in this manner the speed of the HP set is controlled. The servo system for the nozzle utilizes similar servo amplifier and servo valve and feedback to that used in the fuel control.

The speed signal for the main fuel loop is obtained by magnetic pick-ups mounted in close proximity to a 60-tooth wheel on the low-pressure set (load turbine shaft), while the inductor alternator, when used, remains on the compressor stub shaft to produce power and indicate N_{HP} . The set point for this HP set speed is exhaust temperature, firing temperature or a fixed speed, depending on the level of load and the type of cycle. The output of this amplifier is tied into the nozzle servo system.

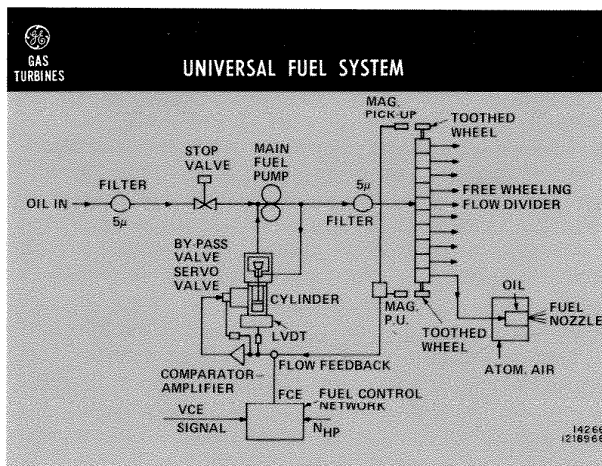

Figure 11

The operation of a regenerative, two-shaft, SPEEDTRONIC controlled gas turbine is planned to give optimum full-load, part-load, as well as off-ambient performance (Fig. 14). This is accomplished by operating the turbine at maximum allowable firing or exhaust temperature. Thus at full load, the HP set is at full speed and the firing temperature (T_F) is at maximum, as determined by exhaust temperature (T_X) and turbine pressure ratio (P_{CD}). As load is reduced, fuel flow is cut back by the LP set governing system; T_F tends to decrease, thus commanding the HP set to slow down by closing the nozzle, until T_F is again at its set-point. The unit is then on nozzle control. As load

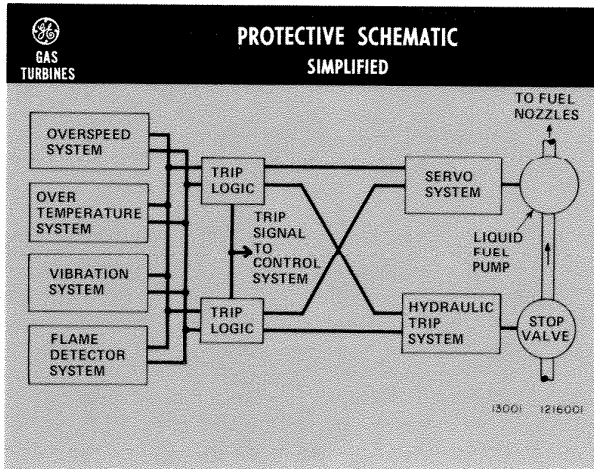

Figure 15

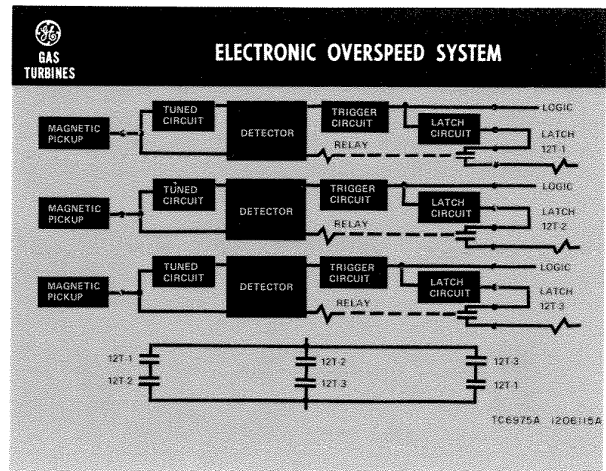

Figure 16

Design

The gas turbine and its driven load, similar to any other prime-mover and its load, must be protected against a number of conditions. These conditions may be broken down into two categories: the simple trip signals, such as pressure switches or system relaying, used for low lube-oil pressure, generator differential, high gas-compressor discharge pressure, or similar; and the more complex parameters such as overspeed, overtemperature, vibration and flame. Here we will deal only with the more complex protection.

Overspeed

Although it is contemplated to retain the option to add the mechanical overspeed bolt and its trip mechanism, the electronic overspeed system is built on the assumption that it is not being backed up by a bolt. The electronic system offers a number of features impossible to obtain with a mechanical system (Fig. 16). The system without the option consists of three independent sub-systems of sensors, amplifiers, and cards. The system is made to detect the status of these three sub-systems before the unit can start up. If any one of the cards indicates that the status is "running" when the unit is standing still, something must be wrong and the unit is not allowed to start. During the starting sequence, before firing (below ten percent speed) the overspeed trip system must revert to the running state or the sequence will not be allowed to proceed, but will alarm. Once the unit is running, should any one of the three sub-systems fail, the unit will continue to run, but will alarm.

Each circuit is designed for an absolute maximum reliability, but any conceivable failure is a

fail-safe one. A failure of a sub-system makes that system tell the unit to shut down, and only the presence of two other sub-systems disputing the trip condition keeps the unit running. However, when the majority indicates a trip state, the unit will trip. An alarm will sound on any abnormality of any of the three sub-systems.

The overspeed trip point, normally set at 110 percent of running speed, is preset and not adjustable – so no tampering can result. Since there are different trip speeds for different machines, and even for the different shafts of a two-shaft machine, the cards are furthermore designed to make it impossible to start with a card in the wrong slot. A further feature, not expected to be used except in a very rare case, is that it is perfectly possible to remove a failed card during running, examine it, and replace it. The mechanical overspeed trip system (when used) is normally set at almost 113 percent.

Overtemperature

The overtemperature system consists of two separate channels (Fig. 17). The input for each of these channels may be either one or three thermocouples entirely separate from the twelve control thermocouples. A comparator looks at these two channels and the control channel, and if at any time, a discrepancy is detected in excess of the preset allowed value, the unit will sound an alarm. Open thermocouple failure of one channel will permit the unit to continue to operate. However, if both overtemperature trip channels should fail open, the unit will trip.

prevent a loss of load from causing an overspeed trip of the load turbine.

General

SPEEDTRONIC control has a number of features built-in to assist the gas turbine and/or the operator. One of these is the "Minimum VCE System", that assures the unit of minimum fuel during cut-back to avoid flame-out. Another feature is the "Manual VCE" control that allows the initial start-up man or any trouble shooter to take control of VCE, thus fuel, in order to completely control the start-up or loading of the turbine. Since this control is operated through the minimum value gate, the other parameters such as speed and temperature can still cut back to protect the turbine.

Control mode indicating lights are located electrically in each of the major input circuits including the acceleration loop, and physically on the front of the panel, with provision for remote indication. Thus, the operator, locally or remotely, can see that the unit is on start-up control, detect when the suppressed temperature takes over, determine when the acceleration control becomes active, and when the unit goes on speed governor. After that, when he has loaded the gas turbine (manually or automatically at his option) to full capability, the red temperature light will come ON, indicating he is at full power for that particular ambient. To further assist him, the governor raise circuit is tied in with the temperature loop in such a manner that after the unit reaches temperature control, the speed set-point will automatically stop increasing. Thus, should the temperature control become disabled, or even be greatly affected by a short circuit or something similar, the governor will immediately take over, a feature we call "redundancy by association". (See Fig. 3.)

In like manner, the range of the speed adjustment is limited by the range of the digital set-point (95 to 107 percent for generator drive; 50 or 80 to 105 percent for mechanical drive). Also, the temperature control is, of course, at all times backing up the governing system. Therefore, in the unlikely event of loss of speed signal, the unit deliberately goes to full-load, a process fail-safe condition allowing the operator to keep producing power until he is ready to shut down and still a safe condition from the point of view of the prime-mover due to the back-up protection.

The net effect of a component or system failure depends on the subsystem, the model, the application, the cycle, and the level of load at the time. The result of a failure in the speed loop will generally go undetected (except for annunciation) since the unit will go to full-load. Loss of the temperature loop will either cause no change, a 2 percent

load increase or, in case of a two-shaft regenerative unit at 50 - 100 percent load, it may trip the unit on high exhaust temperature. For special applications, this unlikely shutdown may be prevented by a redundant temperature loop and other optional features.

These features constitute the "super reliability" system that utilizes redundant main loops and monitors all possible functions to determine the malfunctions or even relatively small drifts. A related feature allows "servicing while running" of most cards in the SPEEDTRONIC page. These systems are sometimes used on industrial applications where many years of continuous operation are required, and for marine use or similar application where a shutdown could prove very expensive or disastrous.

Another optional feature for marine applications is the emergency take-home control, that can be plugged directly into the gas turbine accessory system base in case of total propulsion control system disability. This control can start and stop the turbine and will run it manually at a safe, reduced power level.

PROTECTION SYSTEM

Philosophy

In the design of the protection system, a dual-route, fail-safe philosophy is utilized (Fig. 15). Thus, in case of failure of the protective system, the turbine will shut down, and at least two "trip routes" are available. To obtain maximum running reliability, a system of simple redundancy, and in some areas of double redundancy, is built in. This means that in the case of, for instance, overspeed, there are three systems, so a single failure will still allow the unit to run, but will annunciate. The system is furthermore designed so that even during start-up, it is self-checking, so if the overspeed protection is absent, i.e., if a sensor is missing (as might happen after an overhaul), a wire has broken, or if any failure in the overspeed protection system is detected, the turbine will not start.

Subsequently, when the unit is running, a failure of just one of the channels will just alarm as mentioned before. The same is normally true with the dual-channel overtemperature system. Completely independent of the temperature control system, a typical failure of either one of these channels will just alarm, while failure of both will shut down the turbine. Thus, redundancy for maximum operating reliability, but fail-safeness in case of complete failure, is obtained.

CONTROL SCHEMATIC TWO SHAFT (SIMPLIFIED)

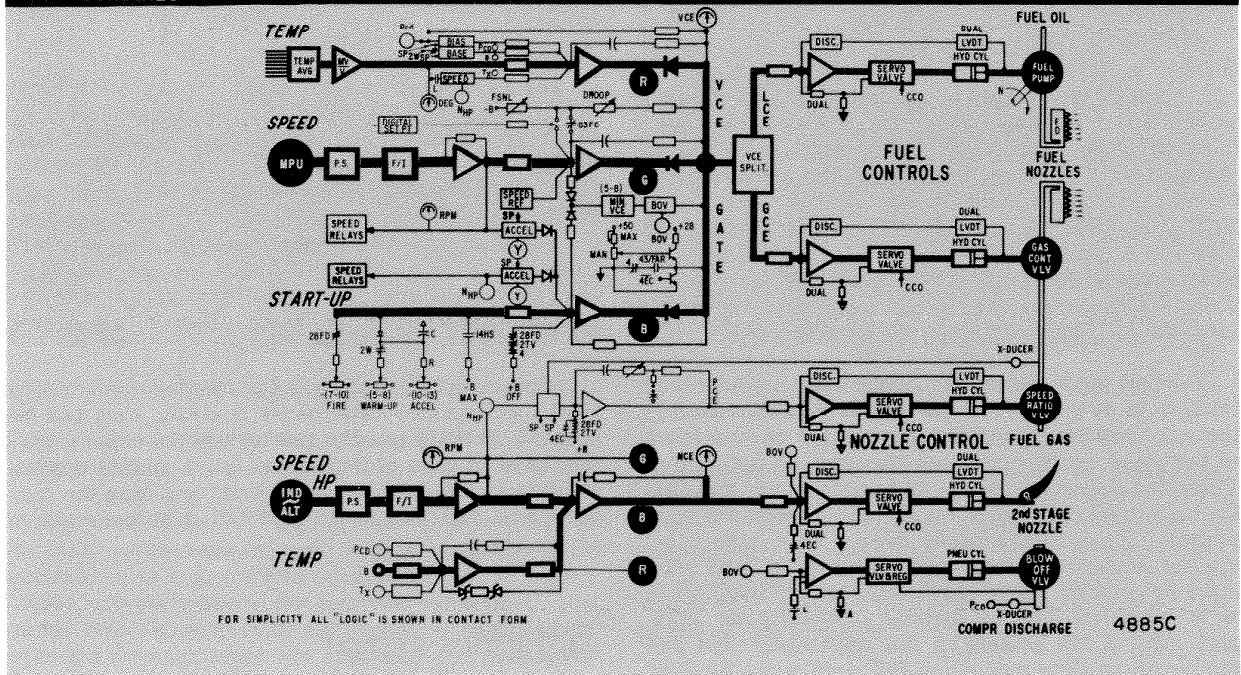

Figure 13

is decreased further, slowing down the HP set, the turbine pressure ratio decreases and T_X reaches its limit. Further decreases in load will cause the nozzle to close, favoring the load turbine, while slowing down the HP set and holding T_X constant. Between one-quarter and one-half load, the HP set reaches its minimum governing speed and T_X will start to drop.

For generator drive applications, with the load turbine at full-speed no-load, the HP set would run at 80 percent (90 percent) speed. For mechanical drive applications, the minimum load turbine speed is normally 50 percent. The HP set speed will depend on the load at that 50 percent point. For lighter loads the variable nozzle will go wide open to hold the 80 percent (90 percent). If the LP torque required is even below this value, N_{HP} will decrease until steady-state is reached at an LP of 50 percent, with the nozzle angle at maximum, and N_{HP} at some point below 80 percent (90 percent).

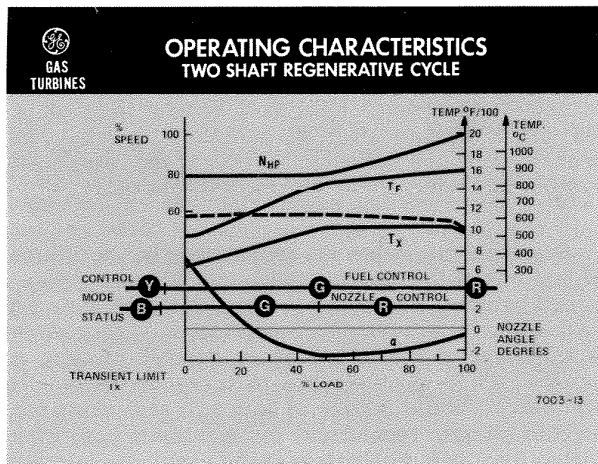

Figure 14

Operating the unit on nozzle control in this manner assures maximum T_F or T_X . In order to pick up load, the HP set must be accelerated, but since the unit is already at its steady-state temperature limit, provision must be made to exceed the steady-state T_X . This is done by a bias from HP set speed that transiently allows the unit to exceed the steady-state T_X , but still limits the T_F to the rated value. This results in a very much improved dynamic response of the whole gas turbine.

On regenerative, two-shaft machines for generator drive, the nozzle control opens the nozzle fully and a regenerator blow-off valve blows off excess energy stored in the hot regenerator in order to

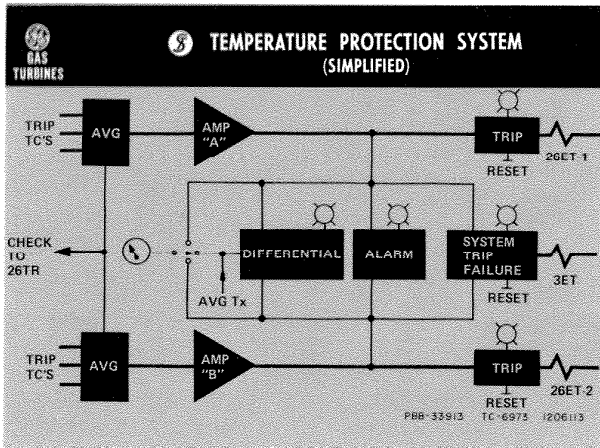

Figure 17

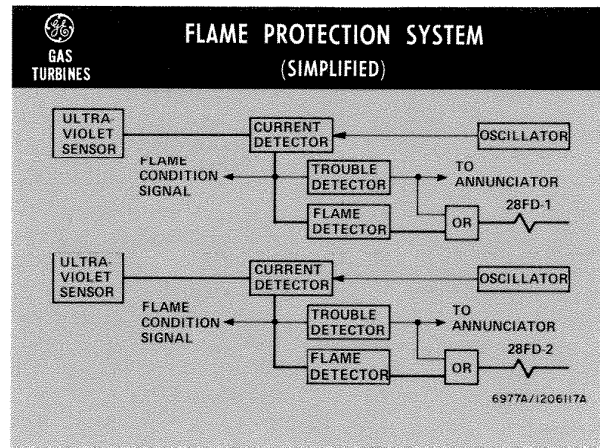

Figure 19

Vibration

The vibration protection normally consists of three velocity-type pick-ups: two on the gas turbine, and one on the load (Fig. 18). For some load compressors, with a high stator-to-rotor weight ratio, a proximity vibration detector is utilized. Its output is treated to make it compatible with the standard velocity pick-up amplification system. The output of these velocity pick-ups is a voltage proportional to velocity and the trip system is normally set at a trip value of one inch-per-second vibration. The three pick-up channels are independent of each other and a calibration card is available to set and check each of these channels. Should any channel become open circuited, grounded, or short circuited, the alarm will sound, but the unit is permitted to continue to operate. An option of

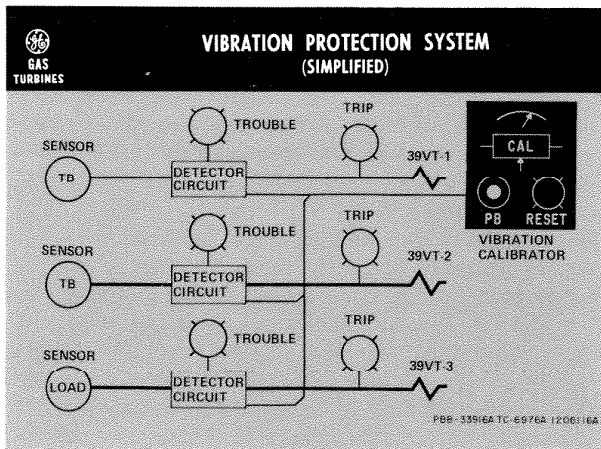

Figure 18

incorporating additional channels is available for applications such as multiple compressor trains.

Flame Detection

The flame detection system consists of two detectors per combustion system (Fig. 19). Thus non-regenerative units have two detectors; regenerative units have four. Flame detectors are utilized both in the start-up sequence and during running. Similar to the overspeed system, the FD system is checked to be in the "Off" condition prior to start, thus protecting against shorts or "failed-on" detectors. Then, after firing speed has been reached, as soon as one detector per system detects flame, the starting sequence is allowed to proceed; conversely, a failure of only one detector will allow the unit to continue to run, but will alarm. With both detectors detecting loss of flame, the unit is immediately shut down. The fast response of flame-out detection is particularly important on machines having exhaust fired equipment, but also on exhaust recovery equipment due to possible accumulation of explosive mixtures. Open circuits and grounds are alarmed similarly to the vibration system.

Hydraulic Trip System

In order to fully protect the gas turbine and, hence, trip the fuel system completely independent of the control system, a hydraulic trip system is used. Figure 20 is a typical schematic diagram of the hydraulic trip system. It shows the components for a single-shaft, dual-fuel gas turbine. The output of the protective system provides the trip signal for the solenoid dump valve(s) 20FG and/or 20FL. The design and operation of the fuel oil stop valve

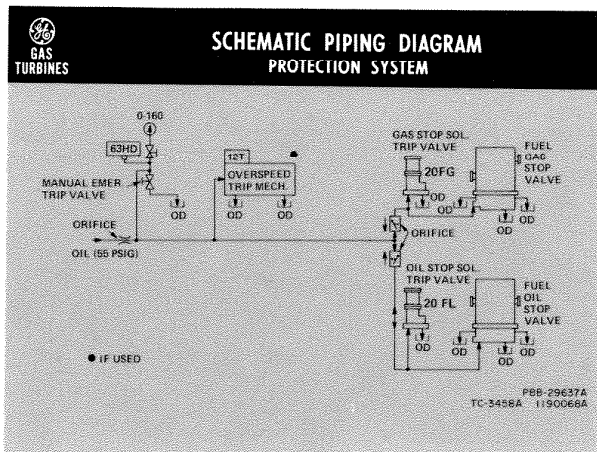

Figure 20

and fuel gas speed-ratio/stop valve are identical and are not described here. The system shown for the dual-fuel turbine permits completely independent operation of the fuel gas speed-ratio/stop valve and the 20FG fuel oil stop valve by operation of 20FG or 20FL and the two orifices in the check valves between the two trip valves. On command of the protective system, both valves are tripped simultaneously, thus closing the oil and gas stop valves. Likewise, the overspeed trip mechanism, if used, and the manual emergency trip valve will trip both valves simultaneously.

The single-fuel turbine would have only one solenoid dump valve.

Complete electrical panel interconnection is provided through pressure switch, 63HD. If for any reason any of the devices trip this system, 63HD provides the signal to the SPEEDTRONIC control panel to completely de-energize and shut down the turbine via both the hydraulic trip system and the control system servo valves. These in turn close the gas control valve and unstroke the fuel pump. Simultaneously, 20FG and 20FL are de-energized as a back-up in the hydraulic trip system to ensure that the dump valve relays close the stop valves.

Annunciator

The annunciator, a logical part of the protection system, is normally a 40-point, back-lighted type, with acknowledge, reset, and lamp test push buttons. The circuits are so set up that only the abnormalities will be indicated. During normal start-up and shut-down, no annunciation will take place. The solid-state annunciator has the "first out" feature, that makes the first annunciation flash with subsequent ones steady.

SEQUENTIAL SYSTEM

Philosophy

A fail-safe philosophy has been used in designing the sequential system; that is, the turbine will be tripped in case of most malfunctions. While maximum turbine starting reliability is indeed important, it is not quite so important to allow the starting cycle to continue as it is to keep the process going when the turbine is running. Good starting reliability has been obtained primarily by careful attention to details and by the use of reliable components, such as solid-state control and protection systems, sealed output relays, safety-rated electronic components, servo valves and pumps. A particular feature further enhancing starting reliability is the use of the multiple start, which means that once the unit has been given a start signal, the failure of the sequence to progress, will automatically revert it to the initial stage, and as soon as the turbine comes down to recoupling speed, it will restart. In this manner, with no further operator attention, it will come up to speed if at all possible. This multiple start takes place over a maximum total duration of twenty minutes. During this time, it will repeat the cycle as often as it is possible.

It should be mentioned here that whereas a number of steps have been taken to improve starting reliability, our past record - before the introduction of the SPEEDTRONIC control system - shows better than 97 percent average with some units at a reported 100 percent starting reliability.

Design

The sequential system consists of a number of inputs such as manually operated switches, remote control signals, gas turbine and load protection parameters, as well as the SPEEDTRONIC control and protection interface signals of permissives, speed and status. These inputs are fed into the standard "logic page" for start-up and shutdown of the turbine and its load, regardless of type. To accommodate the variety of applications encountered such as generator drive, pipeline pumping, mechanical drive, etc, the sequential system is set up to receive external signals at strategic points in the sequence, as well as to provide the process with signals from all important steps, such as Start Signal, Minimum Speed, Fire, 40 percent Speed, Full-Speed, Raise, Lower, Full-Load, etc. The logic consists of sealed relays or solid-state diode-transistor logic and timers to automatically program the start-up from operator local or remote initiation, or automatic black-start, to loaded condition as desired. For instance, they

- (1) activate the auxiliaries,

- (2) engage the clutch,
- (3) crank the unit,
- (4) turn on fuel and set proper amount for firing,
- (5) turn on ignition and detect flame,
- (6) set-up the warm-up time,
- (7) determine speed points,
- (8) detect complete sequence,
- (9) initiate synchronizing,
- (10) close the generator breaker,
- (11) load the unit to the desired point.

Many of the logic outputs are fed into a bank of output relays whose function is to activate or deactivate heavy-duty solenoids and contactors. For this reason, the outputs are normally protected with a resistor-capacitor-diode circuit across the solenoids to prevent high-voltage spikes from being generated. The contacts can handle the solenoids without this protection. The protection network serves to suppress electrical noise, in addition to extending contact life. For manually controlled applications, most of the sequence functions are performed by the operator via the Master Selector Switch on the base, eliminating much of the sequencing equipment.

POWER SUPPLY

Philosophy

Two basically different power supplies are available:

- A. The simple one for applications where the power source is reliable and non-interruptable (battery).
- B. The multiple input one where the power source is AC or the "super reliability" feature is desired and economically justified.

Simple Power Supply

The single input power supply is shown on Fig. 21. Since the battery can be considered a very reliable source of power, a simple inverter-regulator (dc/dc converter) is used, furnishing four regulated dc voltages to the final regulators for P5-volts P and N 12-volts and P28-volts for the SPEEDTRONIC busses. The power for ignition, etc. is furnished directly from the ac line. Black-start is an option

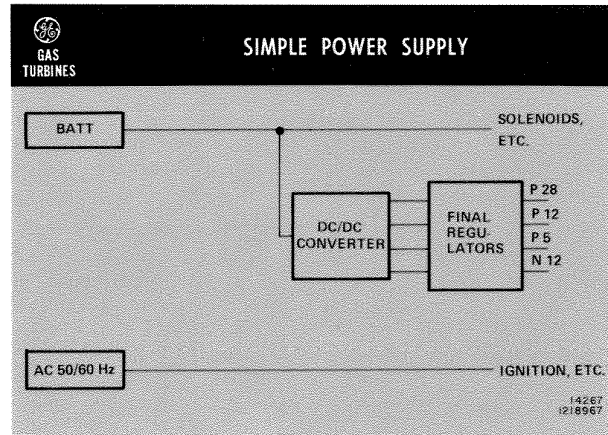

Figure 21

that is achieved by adding a 115-volt 60-Hz inverter which includes an ac power selector (Fig. 22).

Multiple Input Power Supply

The multiple-input power supply (Fig. 23) runs on 115-volt, 50/60-Hz ac, 125-volt dc, or the output from the inductor alternator (if used) of 3600, 5100 or 6900/7100-Hz, depending on the gas turbine model. During starting, one of the first two supplies will be available. While running, the inductor alternator will supply all the power required to run the control, protection, and sequential system; thus, no external power is required for running. Black-start is an option that is achieved by adding a 115-volt, 60-Hz inverter.

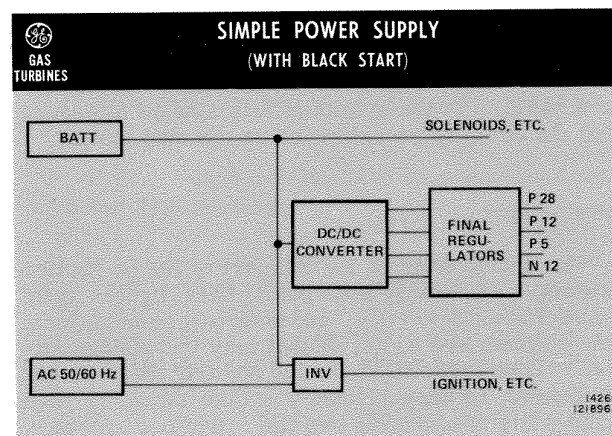

Figure 22

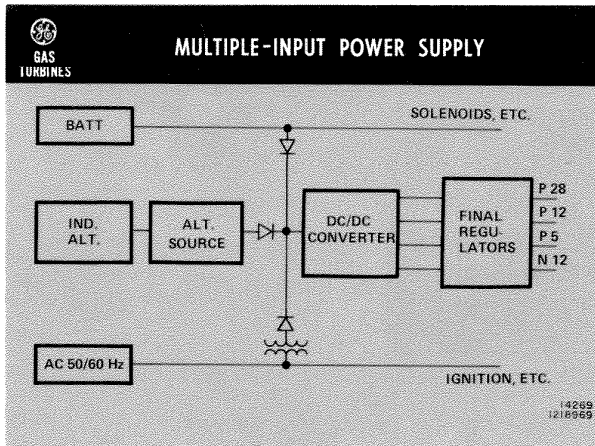

Figure 23

The converter and final regulator can be made redundant, so that even in case of failure of the heart of the power supply, the unit may continue to run, but will alarm.

The control and protection system is furthermore made fail-safe, so that, should all power fail in spite of the system redundancies, the machine will shut-down safely.

The hydraulic power is supplied at the 80-110 atmosphere pressure level (1200-1600 psi) by a shaft-driven pump. On some applications this may be augmented by a motor-driven pump.

Design

Inductor Alternator

When dependable external power is not available, the inductor alternator becomes the key to the reliability of the SPEEDTRONIC control and protection systems. (Fig. 24) The full name is actually a Permanent Magnet, Homo-Polar, Inductor Alternator. It does not require any separate excitation, has no electrical moving parts such as windings or slip rings, has no bearings, requires no alignment (actually the output increases with misalignment), but has a 2-kva, 150-volts, 3 to 7 kilo Hz output, its frequency resulting in greater output for a given physical size. The power is fed to the power supply for conversion to useful voltages as described below, while a frequency signal is fed to the control portion. In addition, the alternator includes four separate isolated windings used for reference and monitoring of the speed control system. Mounted in an adaptor assembly, electrically separate from the inductor alternator, but generating the same

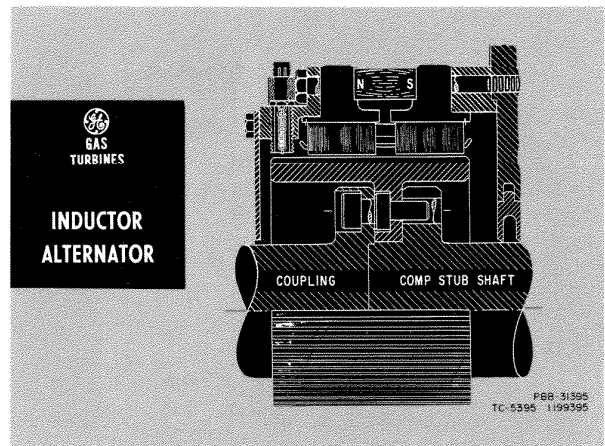

Figure 24

frequency, are magnetic pick-ups whose outputs are fed to the overspeed protection portion as indicated above.

The power supply itself is a non-interruptable, self-contained, multiple-input type. It consists of the following major portions:

A. Power Source Selector

This will accept an input from either or all of the following: 99 - 134 vdc from the battery, 50 - 60 Hz from the line, or optionally, power from the inductor alternator. It has indicating lights to show availability of the ac or dc sources. Its outputs are 95 to 140 volts dc for solenoids, and dc for the converter.

B. Dc/dc Converter

The converter receives dc from the source selector and makes four regulated dc voltages for the final regulators.

C. Final Regulators

The final regulators receive dc from the converter, and produce regulated busses at -12, +5.3, +12 and +28 volts. The system has indicating lights, and overvoltage protection on particular busses.

CONSTRUCTION

Except for the interface components mounted on the turbine itself, all systems are mounted in the SPEEDTRONIC control panel, standardized as a 92 x 92 x 220 cm cubicle (36 x 36 x 90 in.), but expandable to 180 cm (72 in.) depth to line up with walk-in control house design.

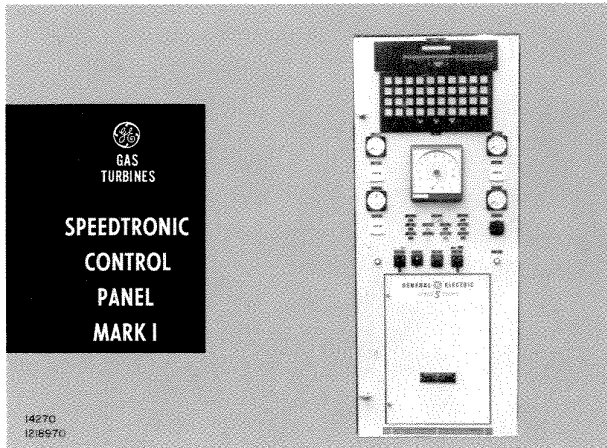

Figure 25



Figure 27

It can be physically divided into three parts: (Example described is Mark II)

a) The front door or panel containing the interface with the operator, all inputs (switches, push buttons, thermocouple average and check module, etc.) and outputs (lights, annunciator, meters, counters), as well as the "page" of control, protection and sequence equipment and associated adaptability adjustments. This page (Fig. 28) employs the optimum combination of integrated circuits and discrete components. It is arranged in rows of up to 18 cards each, (Fig. 29) containing the analog and digital cards of the control and protection systems and of the interface with the sequential and gas turbine components, all arranged functionally and identified for easy tie-in with the elementary diagrams.

b) The inside page (Fig. 30), containing the output relays is arranged in an easily identifiable fashion to facilitate servicing. For manually controlled machines the functions of this page are basically replaced by the operator, the Master Selector Switch on the turbine base, and a few protective relays.

c) The side and back walls where the power supply and all incoming terminal boards, identified for field servicing, are located. From these terminal boards, standardized multi-conductor cables run to the quick disconnects on the turbine junction boxes for fast, reliable field installation and start-up.

FEATURES

Naturally, as a system evolves, particular features change: Some are redundant, some are improved, and new applications require new ones.

The Mark I system, now in operation on over 200 machines, obviously has accumulated the most experience, and we will retain it on some models until a logical introduction point is reached.

Speedtronette, the simplified version specifically designed for the MS 1000, but also acting as a prototype for the Mark II analog portion, has led the way to the optimum utilization of integrated circuits (IC's).

Mark II utilizes the experience gained from Mark I, the development program and tests of the analog systems in Speedtronette, as well as the application of digital technology incorporating the latest micrologic components in special gas turbine printed circuit cards for the protection, sequential and annun-

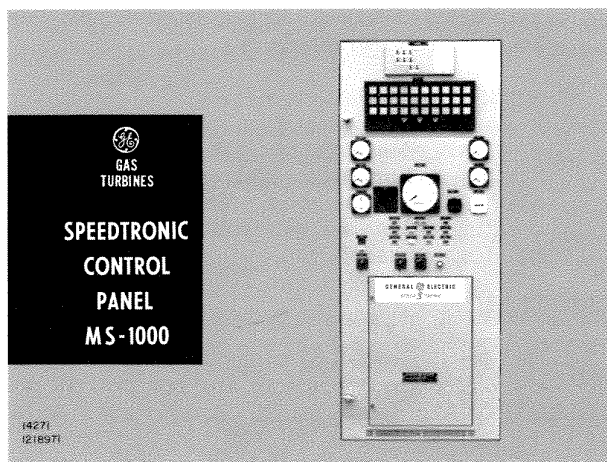

Figure 26

ciator circuits previously done by relaying. In addition, some simplification has been done at the same

time. The main features that are different for the 3 types of controls are tabulated below:

SPEEDTRONIC FEATURES

Standard Panel 36x36x90 inches (92x92x220 cm)

(Key features listed below are those that differ in the 3 models. Some are optional.)

<u>Mark I</u>	<u>Speedtronette</u>	<u>Mark II</u>
All Inclusive System (Max. Redundancy)	Simplified System (Min. Redundancy)	Streamlined System (Redundancy)
I. C. TC's	C. A. TC's	C. A. TC's
Isol. temp sens.	Non-isol. temp sens.	Non-isol. temp sens.
Start temp. supp.	No temp. supp.	New temp. supp.
Separate Tx meter	No sep. Tx meter	No sep. Tx meter
Big temp. ind.	DB16 temp. ind.	DB16 temp. ind.
Discreet comp., few IC's	Max. util. of IC's	Max. util. of IC's
Relay sequential	Relay sequential	Solid state seq., with output relays
Std. GT wiring	Std. GT wiring	GT ring bus.
40 LT ann.	30 LT ann.	40 LT ann. with 1st out
Dual LVDT's (std)	Single LVDT's	Dual LVDT's (opt)
Many adjustments	Few adjustments	Min. adjustments
OS bolt std.	OS bolt opt.	OS bolt opt.
12 bit dig. S. P. servo	10 bit dig. S. P. servo	New 12 bit IC S. P. servo
Univ. fuel syst (opt)		Univ. fuel syst (std)
Std. VIB syst with readout	Std. VIB syst	Adaptable VIB syst front read- out (opt)
		IGV control
		Water injection
Relay ind. of major function status	Relay ind. of major function status	LED ind. of major function status
		LED ind. of inputs
Super reliability		Super reliability
		Emergency take-home control
		Power control loop
3 input, redundant, black start, std. (P12, P28, P&N 50 Volt)	AC input (P5, P&N 12, P28 Volt)	DC input, std. 3 input, redun- dant reg, black start (opt) (P5, P&N 12, P28 Volt)
Std. 4-20 VCE Range (4-20 V)	Std. 4-20 VCE Range (2-10 V)	Std. 4-20 VCE Range (2-10 V)
See Fig. 25	See Fig. 26	See Fig. 27

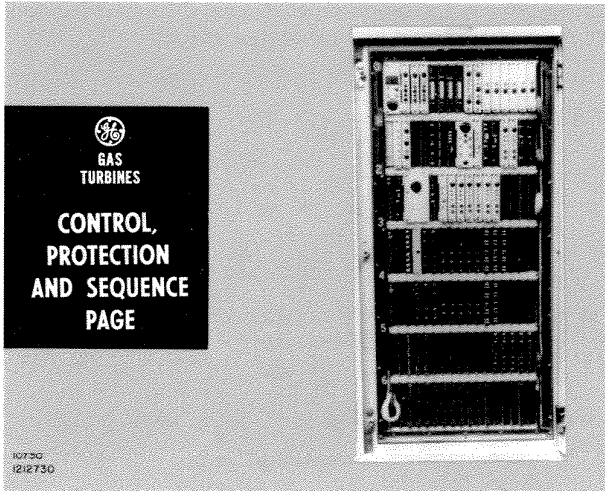

Figure 28

APPLICATION

General Electric heavy-duty gas turbines cover a wide application and power range. All applications utilizing a given model series GT utilize the same basic SPEEDTRONIC control system. The evolution from Mark I through Speedtronette to Mark II has however been done on a deliberate model by model planned basis, generally building a prototype prior to mass production. Table I outlines the actual past introduction dates of Mark I, Speedtronette and Mark II as well as the best estimate for the future introduction dates of the Mark II controls.

OPERATING EXPERIENCE

A lengthy period of test and evaluation prior to the introduction of the SPEEDTRONIC control and

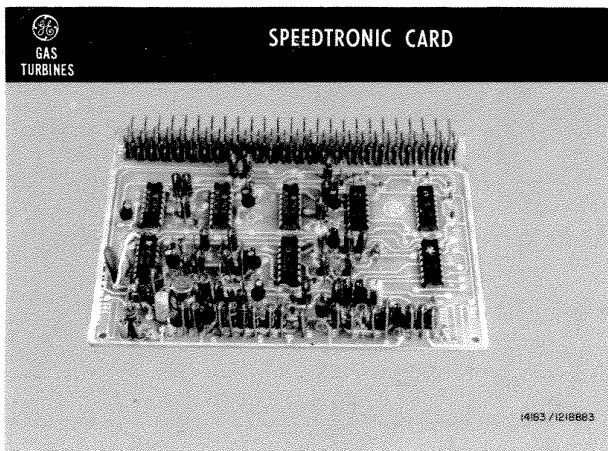

Figure 29

TABLE I
SPEEDTRONIC
CONTROL SYSTEM
SCHEDULED SERVICE DATES

Control	Mark I	Speed- tronette	Mark II
Gas Turbine Model			
1002		1971P 1972	
3002	1969		1972P 1973
5001	1967P 1969		1972P 1973
5002			1971P 1972
7001	1970P 1971		1973(P)
7002			1973(P)
9001			1974(P)

P = Prototype (P) = Prototype - immediately followed by production

protection system as standard production equipment for late 1969 shipments, has been in progress. The program outlined below is in keeping with our emphasis on reliability and has exposed the SPEEDTRONIC system to a variety of operating environments providing well-proven components for production units.

QUALIFICATION TESTS

May - June 1966

Bread-board control system on outdoor test bed with production gas turbine at full load.

October 1967

Prototype SPEEDTRONIC control panel on production turbine.

Equipment is installed on new test stand and is in service as factory production test facility.

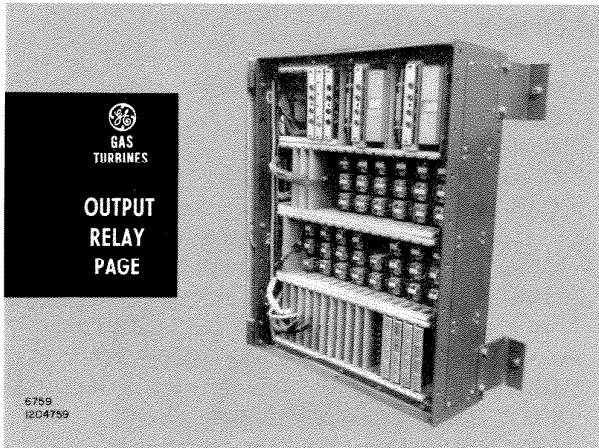

Figure 30

May 1968

Modified existing gas turbine installation in the field to SPEEDTRONIC control and ran in commercial operation. Originally scheduled for a minimum of one year, - now purchased by the customer.

In the four years since 1968, the electronic control system has been in service 35,000 hours. During this time, the unit has performed over 1000 fully-automatic starts, including 50 fast starts, mostly by remote control, and had two failures, i. e. 99.8 percent starting reliability. The turbine has operated about 2400 hours, producing over 36,000 mwh with only one forced outage, i. e. 99.96 percent running reliability. The system had two unavailable periods, one due to a failure in a prototype card, one due to an underground cable fault, for a total of 100 hours, i. e. 99.7 percent availability. The card was redesigned and has operated successfully during the 30,000 hours since its installation.

Fast-start, an optional feature, brings the unit from rest to pre-selected load within three minutes (Fig. 31). A 400 Mw steam station was started and brought on the line by the gas turbine after it had made a fast, dead-bus start, with an isochronous governor. Speed deviation was less than 0.1 Hz even during the starting of two 3500 hp forced draft fans.

January 1969

Production SPEEDTRONIC control system on two-shaft turbine for factory test operated on isochronous speed and isothermal temperature control. (Fig. 32)

April 1971

Factory test of MS 1000, a 4500 hp machine, using an early version of the Mark II control.

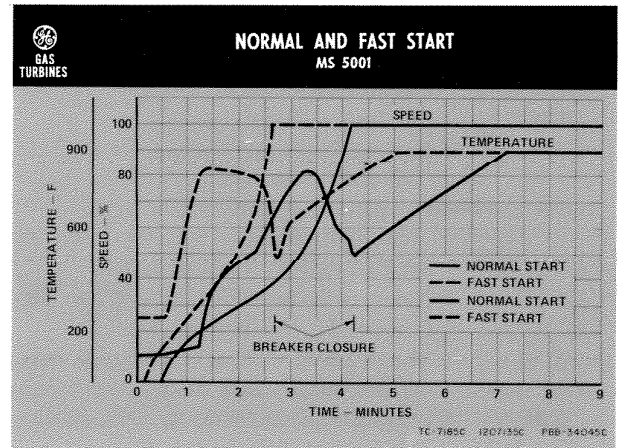

Figure 31

June 1971

Factory test of MS 5000 machine on the prototype Mark II control.

1972

Initial service of Speedtronette (MS 1002) and Mark II (3002, 5001, 5002).

CONCLUSION

The system was designed to provide the ultimate turbine user with the highest degree of reliability, performance, and adaptability in turbine control. Its record to date indicates that it has more than fulfilled our expectations.

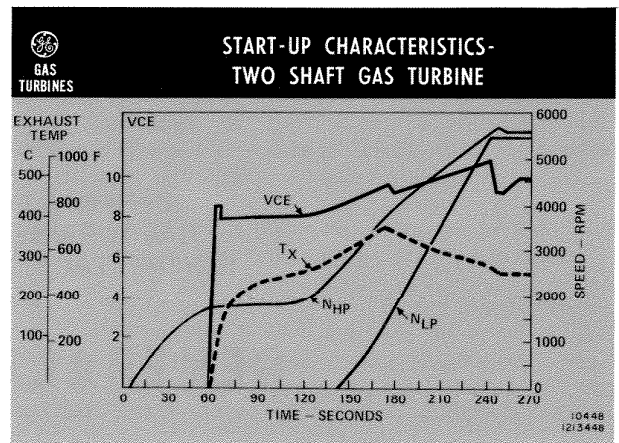

Figure 32

GAS TURBINE REFERENCE LIBRARY

GER-2182	Gas Turbine Materials	GER-2474	Stationary Components Design
GER-2222	Gas Turbine Fuels	GER-2475	Rotor Design
GER-2229	Gas Turbine Energy Systems for the Process Industries	GER-2476	Fuel Systems
GER-2244	Gas Turbine Applications on Small Utility Systems	GER-2477	Combustion System
GER-2461	SPEEDTRONIC* Control System	GER-2478	Design and Application of Heat Recovery Steam Generators
GER-2462	Auxiliary Systems for Increased Flexibility	GER-2479	Rotor System Dynamics
GER-2465	Combined-cycle Thermodynamics	GER-2481	Technological Differences in the Design of Heavy-duty Gas Turbines and Aircraft Engines
GER-2467	The Dynamic Analysis of Energy Systems	GER-2483	General Electric Heavy-duty Gas Turbine Design Philosophy
GER-2468	Oil, Air, and Water Systems	GER-2484	Heavy Fuel Treatment Systems
GER-2469	Inlet, Exhaust and Silencing Systems	GER-2485	Heavy-duty Gas Turbine Reliability
GER-2470	Five Basic Modular Packages	GER-2486	Heavy-duty Gas Turbines in the Environment 1972
GER-2471	Application of Centrifugal Compressors in the Gas Industry	GER-2487	Mass Injection Gas Turbine
GER-2472	Centrifugal Compressors in Process Applications	GER-2488	Gas Turbine Acoustical Considerations
GER-2473	Thermodynamics and Performance		

CANADIAN GENERAL ELECTRIC COMPANY
1900 Eglinton Avenue, East
Scarborough, Ontario, Canada

GENERAL ELECTRIC COMPANY
International Sales Division
159 Madison Avenue
New York City, New York 10016 U.S.A.

MANUFACTURING ASSOCIATES

AEG-KANIS TURBINENFABRIK GMBH
Essen, Germany

HITACHI, LIMITED
Tokyo, Japan

ALSTHOM, SOCIETE GENERALE DE CONSTRUCTIONS
ELECTRIQUES ET MECANIQUES
Belfort, France

NV MOTORENFABRIEK THOMASSEN
De Steeg, Holland

JOHN BROWN ENGINEERING (CLYDEBANK) LIMITED
Clydebank
Dunbartonshire, Scotland

NUOVO PIGNONE
Florence, Italy

A. S. KVAERNER BRUG
Oslo, Norway

GENERAL ELECTRIC COMPANY
GAS TURBINE PRODUCTS DIVISION
SCHENECTADY, NEW YORK, 12345 U.S.A.

GENERAL  ELECTRIC